

RCA

RECEIVING TUBE

Manual



TUBE DEPARTMENT

RADIO CORPORATION of AMERICA

HARRISON, N. J.

TECHNICAL SERIES RC 15

PRICE 35 CENTS

CONTENTS

	PAGE
ELECTRONS, ELECTRODES, AND ELECTRON TUBES	3
Electrons, Cathodes, Generic Tube Types, Diodes, Triodes, Pentodes, Beam Power Tubes, Multi-Electrode and Multi-Unit Types	
ELECTRON TUBE CHARACTERISTICS	10
ELECTRON TUBE APPLICATIONS	12
Amplification, Rectification, Detection, Automatic Volume Control, Tuning Indication with Electron-Ray Tubes, Oscillation, Frequency Conversion, Automatic Frequency Control	
ELECTRON TUBE INSTALLATION	44
Filament and Heater Supply, Heater-to-Cathode Connection, Plate Voltage Supply, Grid Voltage Supply, Screen Voltage Supply, Shield- ing, Dress of Circuit Leads, Filters, Output-Coupling Devices	
INTERPRETATION OF TUBE DATA	52
RECEIVING TUBE CLASSIFICATION CHART	56
MINIATURE TUBE LIST	58
TUBE TYPES—Technical Data	59
ELECTRON TUBE TESTING	190
RESISTANCE-COUPLED AMPLIFIERS	194
CIRCUITS	211
OUTLINES	229
INDEX	237
RECENTLY ADDED TUBE TYPES	241
READING LIST	256

Key to Socket Connection Diagrams

Bottom Views

BC = Base Sleeve	H = Heater	K = Cathode
BS = Base Shell	HL = Heater Tap for Panel Lamp	NC = No Connection
DJ = Deflecting Elec- trode	HM = Heater Mid- Tap	P = Plate (Anode)
ES = External Shield	IC = Internal Connec- tion— Do Not Use	RC = Ray-Control Electrode
F = Filament	IS = Internal Shield	S = Shell
FM = Filament Mid- Tap		TA = Target
G = Grid		U = Unit
		● = Gas-Type Tube

Alphabetical Subscripts B,D,HP,HX,P, and T indicate, respectively, beam unit, diode unit, heptode unit, hexode unit, pentode unit, and triode unit in multi-unit types.

See page 241 for
recently added types.

RCA RECEIVING TUBE MANUAL

THIS MANUAL like its preceding editions has been prepared to assist those who work or experiment with electron tubes and circuits. It will be found valuable by engineers, radio servicemen, technicians, experimenters, students, radio amateurs, and all others technically interested in electron tubes.

The material in this edition has been augmented and extensively revised to keep abreast of the technological advances in electronic fields. Many tube types widely used in the design of new electronic equipment prior to the war are now chiefly of renewal interest; in their place, new advanced types including the miniatures are being used. Consequently, in the Tube Types Section, the presentation on the older types has been limited to essential basic data while detailed information has been given on the newer more important types.

In addition to the tube types covered in this Manual, the TUBE DEPARTMENT of RADIO CORPORATION OF AMERICA offers a complete line of electron tubes including:

CATHODE-RAY TUBES

*Kinescopes and
Oscillograph Types*

TELEVISION CAMERA TUBES

*Iconoscopes and
Image Orthicons*

PHOTOTUBES

*Single-Unit, Twin-Unit,
and Multiplier Types*

POWER TUBES

*Transmitting and
Industrial Types*

THYRATRONS & IGNITRONS

SPECIAL TYPES

*Acorn Types, Lighthouse
Types, Vacuum-Gauge
Tubes, and Specialized-
Application Types*

For Sales Information
on RCA Tubes, write to
Sales Division

For Technical Information
on RCA Tubes, write to
Commercial Engineering

TUBE DEPARTMENT
RADIO CORPORATION OF AMERICA
Harrison, N. J.

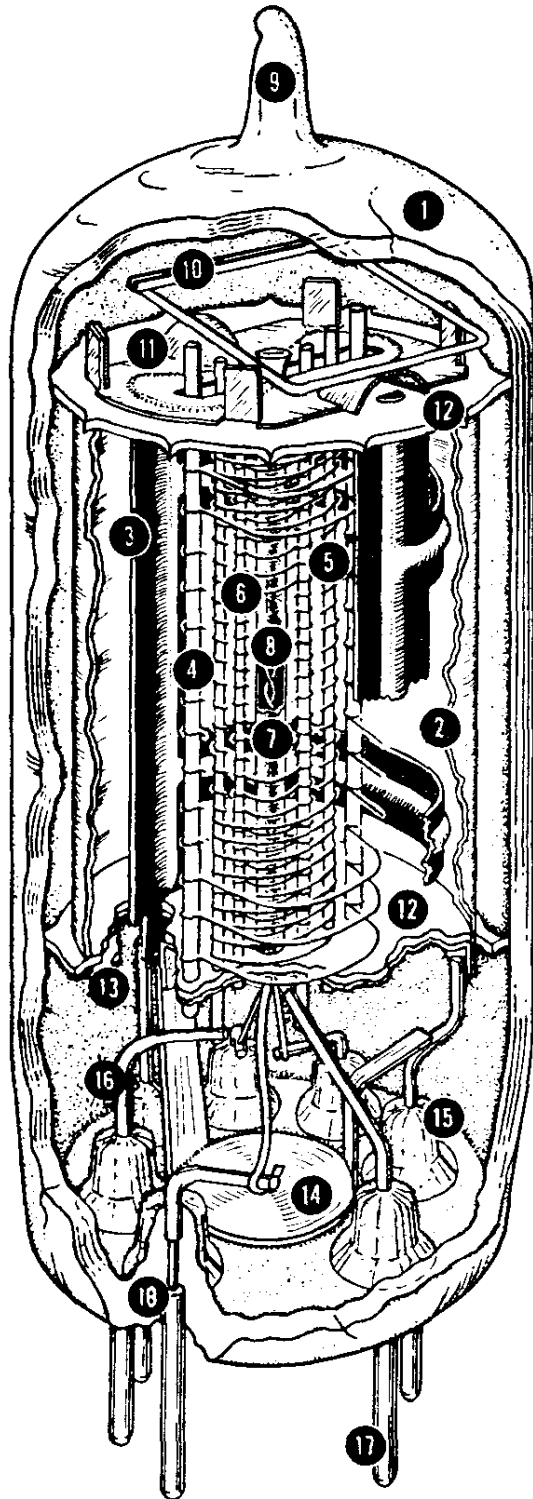

2½ times actual size

- 1 – Glass Envelope
- 2 – Internal Shield
- 3 – Plate
- 4 – Grid No. 3 (Suppressor)
- 5 – Grid No. 2 (Screen)
- 6 – Grid No. 1 (Control Grid)
- 7 – Cathode
- 8 – Heater
- 9 – Exhaust Tip
- 10 – Getter
- 11 – Spacer Shield Header
- 12 – Insulating Spacer
- 13 – Spacer Shield
- 14 – Inter-Pin Shield
- 15 – Glass Button-Stem Seal
- 16 – Lead Wire
- 17 – Base Pin
- 18 – Glass-to-Metal Seal

Structure of a Miniature Tube

RCA RECEIVING TUBE MANUAL

Electrons, Electrodes, and Electron Tubes

The electron tube is a marvelous device. It makes possible the performing of operations, amazing in conception, with a precision and a certainty that are astounding. It is an exceedingly sensitive and accurate instrument—the product of coordinated efforts of engineers and craftsmen. Its construction requires materials from every corner of the earth. Its use is world-wide. Its future possibilities, even in the light of present-day accomplishments, are but dimly foreseen; for each development opens new fields of design and application.

The importance of the electron tube lies in its ability to control almost instantly the flight of the millions of electrons supplied by the cathode. It accomplishes this with a minimum of control energy. Because it is almost instantaneous in its action, the electron tube can operate efficiently and accurately at electrical frequencies much higher than those attainable with rotating machines.

ELECTRONS

All matter exists in the solid, liquid, or gaseous state. These three forms consist entirely of minute divisions known as molecules. Molecules are assumed to be composed of atoms. According to a present accepted theory, atoms have a nucleus which is a positive charge of electricity. Around this nucleus revolve tiny charges of negative electricity known as **electrons**. Scientists have estimated that these invisible bits of electricity weigh only 1/30-billion, billion, billion, billionths of an ounce, and that they may travel at speeds of thousands of miles per second.

Electron movement may be accelerated by the addition of energy. Heat is one form of energy which can be conveniently used to speed up the electron. For example, if the temperature of a metal is gradually raised, the electrons in the metal gain velocity. When the metal becomes hot enough to glow, some electrons may acquire sufficient speed to break away from the surface of the metal. This action, which is accelerated when the metal is heated in a vacuum, is utilized in most electron tubes to produce the necessary electron supply.

An electron tube consists of a cathode, which supplies electrons, and one or more additional electrodes, which control and collect these electrons, mounted in an evacuated envelope. The envelope may be a glass bulb or a metal shell.

CATHODES

A cathode is an essential part of an electron tube because it supplies the electrons necessary for tube operation. When energy in some form is applied to the cathode, electrons are released. Heat is the form of energy generally used. The method of heating the cathode may be used to distinguish between the different forms of cathodes. For example, a directly heated cathode, or filament-cathode, is a wire heated by the passage of an electric current. An indirectly heated cathode, or heater-cathode, consists of a filament, or heater, enclosed in a metal sleeve. The sleeve carries the electron-emitting material on its outside surface and is heated by radiation and conduction from the heater.

A filament, or directly heated cathode, may be further classified by identifying the filament or electron-emitting material. The materials in regular use are tungsten, thoriated tungsten, and metals which have been coated with alkaline-earth oxides. Tungsten filaments are made from the pure metal. Since they must operate at high temperatures (a dazzling white) to emit sufficient electrons, a relatively large amount of filament power is required. Thoriated-tungsten filaments are made from tungsten impregnated with thoria. Due to the presence of thorium, these filaments liberate electrons at a more moderate temperature of about 1700°C (a bright yellow) and are, therefore, much more economical of filament power than are pure tungsten filaments. Alkaline earths are usually applied as a coating on a nickel alloy wire or ribbon. This coating, which is dried in a relatively thick layer on the filament, requires only a very low temperature of about 700-750°C (a dull red) to produce a copious supply of electrons. Coated filaments operate very efficiently and require relatively little filament power. However, each of these cathode materials has special advantages which determine the choice for a particular application.

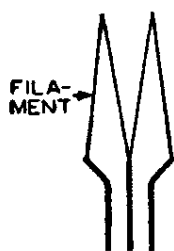

Fig. 1

Directly heated filament-cathodes require comparatively little heating power. They are used in almost all of the tube types designed for battery operation because it is, of course, desirable to impose as small a drain as possible on the batteries. Examples of battery-operated filament types are the 1A7-GT, 1R5, 1U4, 3V4, and 31. AC-operated types having directly heated filament-cathodes include the 2A3 and 5Y3-GT.

An indirectly heated cathode, or heater-cathode, consists of a thin metal sleeve coated with electron-emitting material. Within the sleeve is a heater which is insulated from the sleeve. The heater is made of tungsten or tungsten-alloy wire and is used only for the purpose of heating the cathode sleeve and sleeve coating to an electron-emitting temperature. Useful emission does not take place from the heater wire.

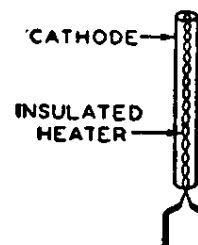

Fig. 2

The heater-cathode construction is well adapted for use in electron tubes intended for operation from ac power lines and from storage batteries. The use of separate parts for emitter and heater functions, the electrical insulation of the heater from the emitter, and the shielding effect of the sleeve may all be utilized in the design of the tube to minimize the introduction of hum from the ac heater supply and to minimize electrical interference which might enter the tube circuit through the heater-supply line. From the viewpoint of circuit design, the heater-cathode construction offers advantages in connection flexibility due to the electrical separation of the heater from the cathode. Another advantage of the heater-cathode construction is that it makes practical the design of a rectifier tube with close spacing between its cathode and plate, and of an amplifier tube with close spacing between its cathode and grid. In a close-spaced rectifier tube the voltage drop in the tube is low and the regulation is, therefore, improved. In an amplifier tube, the close spacing increases the gain obtainable from the tube. Because of the advantages of the heater-cathode construction, almost all present-day receiving tubes designed for ac operation have heater-cathodes.

GENERIC TUBE TYPES

Electrons are of no value in an electron tube unless they can be put to work. A tube is, therefore, designed with the parts necessary to utilize electrons as well as to produce them. These parts consist of a cathode and one or more supplementary electrodes. The electrodes are enclosed in an evacuated envelope with the necessary connections brought out through air-tight seals. The air is removed from the envelope to allow free movement of the electrons and to prevent injury to the emitting surface of the cathode. When the cathode is heated, electrons leave

the cathode surface and form an invisible cloud in the space around it. Any positive electric potential within the evacuated envelope will offer a strong attraction to the electrons (unlike electric charges attract; like charges repel).

DIODES

The simplest form of electron tube contains two electrodes, a cathode and an anode (plate) and is often called a diode, the family name for a two-electrode tube. In a diode, the positive potential is supplied by a suitable electrical source connected between the plate terminal and a cathode terminal. Under the influence of the positive plate potential, electrons flow from the cathode to the plate and return through the external plate-battery circuit to the cathode, thus completing the circuit. This flow of electrons is known as the plate current, and may be measured by a sensitive current meter.

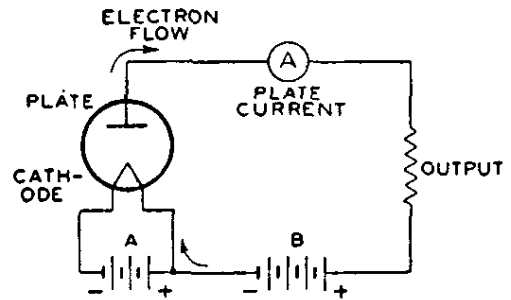

Fig. 3

If a negative potential is applied to the plate, the free electrons in the space surrounding the cathode will be forced back to the cathode and no plate current will flow. Thus, electrons can flow from the cathode to the plate but not from the plate to the cathode.

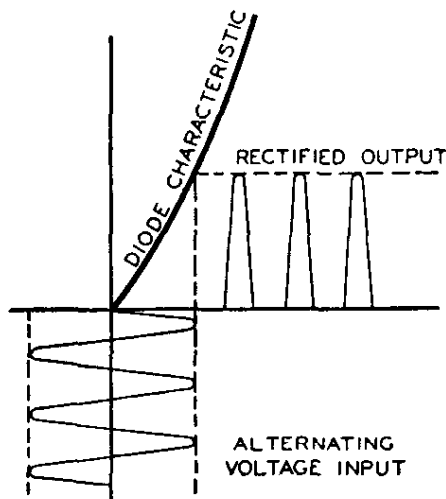

Fig. 4

If an alternating voltage is applied to the plate, the plate is alternately made positive and negative. Plate current flows only during the time when the plate is positive. Hence the current through the tube flows in one direction and is said to be rectified. See Fig. 4. Diode rectifiers are used in ac receivers to convert ac to dc voltage for the electrodes of the other tubes in the receiver. Rectifier tubes may have one plate and one cathode. The 1-v and 35W4 are of this form and are called **half-wave rectifiers**, since current can flow only during one-half of the alternating-current cycle. When two plates and one or more cathodes are used in the same tube, current may be obtained on both halves of the ac cycle. The

6X4, 5Y3-GT, and 5U4-G are examples of this type and are called **full-wave rectifiers**.

Not all of the electrons emitted by the cathode reach the plate. Some return to the cathode while others remain in the space between the cathode and plate for a brief period to produce an effect known as **space-charge**. This charge has a repelling action on other electrons which leave the cathode surface and impedes their passage to the plate. The extent of this action and the amount of space-charge depend on the cathode temperature and the plate potential. The higher the plate potential, the less is the tendency for electrons to remain in the space-charge region and repel others. This effect may be noted by applying increasingly higher plate voltages to a tube operating at a fixed heater or filament voltage. Under these conditions, the maximum number of available electrons is fixed, but increasingly higher plate voltages will succeed in attracting a greater proportion of the free electrons.

Beyond a certain plate voltage, however, additional plate voltage has little effect in increasing the plate current. The reason is that all of the electrons emitted by the cathode are already being drawn to the plate. This maximum current is called **saturation current** (see Fig. 5) and because it is an indication of the total number of electrons emitted, it is also known as the **emission current**, or, simply,

emission. Tubes are sometimes tested by the measurement of their emission current but it is generally not advisable to measure the full value of emission because this value would be sufficiently large to cause change in the tube's characteristics or even to damage the tube. Consequently, while the test value of emission current is somewhat larger than the maximum current which will be required from the cathode in the use of the tube, it is ordinarily less than the full emission current. The emission test, therefore, is used to indicate whether the cathode can supply a sufficient number of electrons for satisfactory operation of the tube.

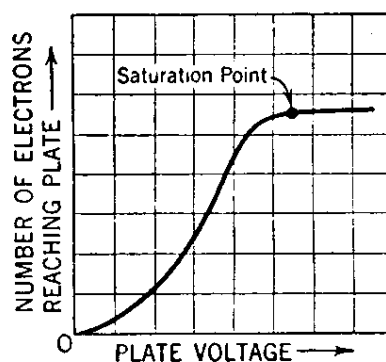

Fig. 5

If space charge were not present to repel electrons coming from the cathode, it follows that the same plate current could be produced at a lower plate voltage. One way to make the effect of space charge small is to make the distance between plate and cathode small. This method is used in rectifier types, such as the 5V4-G and the 25Z6-GT, having heater-cathodes. In these types the radial distance between cathode and plate is only about two hundredths of an inch. Another method of reducing space-charge effect is utilized in the mercury-vapor rectifier tubes, such as the 83. This tube contains a small amount of mercury, which is partially vaporized when the tube is operated. The mercury vapor consists of mercury atoms permeating the space inside the bulb. These atoms are bombarded by the electrons on their way to the plate. If the electrons are moving at a sufficiently high speed, the collisions will tear off electrons from the mercury atoms. When this happens, the mercury atom is said to be "ionized," that is, it has lost one or more electrons and, therefore, is charged positive. Ionization, in the case of mercury vapor, is made evident by a bluish-green glow between the cathode and plate. When ionization due to bombardment of mercury atoms by electrons leaving the cathode occurs, the space-charge is neutralized by the positive mercury ions so that increased numbers of electrons are made available. A mercury-vapor rectifier has a small voltage drop between cathode and plate (about 15 volts). This drop is practically independent of current requirements up to the limit of emission of electrons from the cathode, but is dependent to some degree on bulb temperature.

An ionic-heated-cathode rectifier tube is another type which depends for its operation on gas ionization. The 0Z4 and 0Z4-G are tubes in this classification. They are of the full-wave design and contain two anodes and a coated cathode sealed in a bulb under a reduced pressure of inert gas. The cathode in each of these types becomes hot during tube operation but the heating effect is caused by bombardment of the cathode by the ions from within the tube rather than by heater or filament current from an external source. The internal structure of the tube is designed so that when sufficient voltage is applied to the tube, ionization of the gas occurs between the anode which is instantaneously positive and the cathode. Under normal operating voltages, ionization does not take place between the anode that is negative and the cathode. This, of course, satisfies the requirements for rectification. The initial small flow of current through the tube is sufficient to raise the cathode temperature quickly to incandescence whereupon the cathode emits electrons. The voltage drop in such tubes is slightly higher than that of the usual hot-cathode gas rectifiers because energy is taken from the ionization discharge to keep the cathode at operating temperature. Proper operation of these rectifiers requires a minimum flow of load current at all times in order to maintain the cathode at the temperature required to supply sufficient emission.

TRIODES

When a third electrode, called the grid, is placed between the cathode and plate, the tube is known as a triode, the family name for a three-electrode tube.

The grid usually is a winding of wire extending the length of the cathode. The spaces between turns are comparatively large so that the passage of electrons from cathode to plate is practically unobstructed by the turns of the grid. The purpose of the grid is to control the flow of plate current. When a tube is used as an amplifier, a negative dc voltage is usually applied to the grid. Under this condition the grid does not draw appreciable current.

The number of electrons attracted to the plate depends on the combined effect of the grid and plate polarities. When the plate is positive, as is normal, and the dc grid voltage is made more and more negative, the plate is less able to attract electrons to it and plate current decreases. When the grid is made less and less negative (more and more positive), the plate more readily attracts electrons to it and plate current increases. Hence, when the voltage on the grid is varied in accordance with a signal, the plate current varies with the signal. Because a small voltage applied to the grid can control a comparatively large amount of plate current, the signal is amplified by the tube. Typical three-electrode tube types are the 6C4, 6J5, and 2A3.

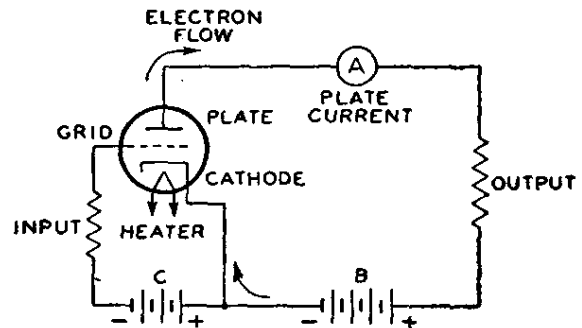

Fig. 6

The grid, plate, and cathode of a triode form an electrostatic system, each electrode acting as one plate of a small capacitor. The capacitances are those existing between grid and plate, plate and cathode, and grid and cathode. These capacitances are known as **interelectrode capacitances**. Generally, the capacitance between grid and plate is of the most importance. In high-gain radio-frequency amplifier circuits, this capacitance may act to produce undesired coupling between the **input circuit**, the circuit between grid and cathode, and the **output circuit**, the circuit between plate and cathode. This coupling is undesirable in an amplifier because it may cause instability and unsatisfactory performance.

TETRODES

The capacitance between grid and plate can be made small by mounting an additional electrode, called the screen (grid No. 2), in the tube. With the addition of the screen, the tube has four electrodes and is, accordingly, called a tetrode. The screen is mounted between the grid and the plate and acts as an electrostatic shield between them, thus reducing the grid-to-plate capacitance. The effectiveness of this shielding action is increased by connecting a bypass capacitor between screen and cathode. By means of the screen and this bypass capacitor, the grid-plate capacitance of a tetrode is made very small. In practice, the grid-plate capacitance is reduced from several micromicrofarads ($\mu\mu\text{f}$) for a triode to $0.01 \mu\mu\text{f}$ or less for a screen-grid tube.

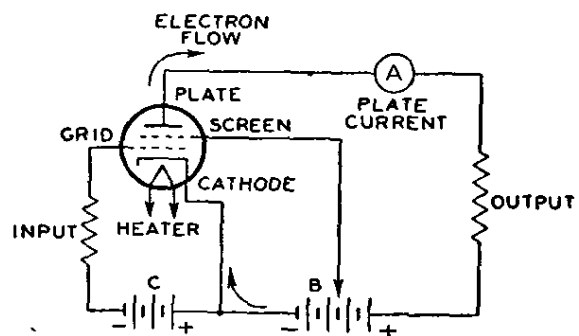

Fig. 7

The screen has another desirable effect in that it makes plate current practically independent of plate voltage over a certain range. The screen is operated at a positive voltage and, therefore, attracts electrons from the cathode. But because of the comparatively large space between wires of the screen, most of the electrons drawn to the screen pass through it to the plate. Hence the screen supplies an electrostatic force pulling electrons from the cathode to the plate. At the same

time the screen shields the electrons between cathode and screen from the plate so that the plate exerts very little electrostatic force on electrons near the cathode. So long as the plate voltage is higher than the screen voltage, plate current in a screen-grid tube depends to a great degree on the screen voltage and very little on the plate voltage. The fact that plate current in a screen-grid tube is largely independent of plate voltage makes it possible to obtain much higher amplification with a tetrode than with a triode. The low grid-plate capacitance makes it possible to obtain this high amplification without plate-to-grid feedback and resultant instability. Representative screen-grid types are the 32 and 24-A.

PENTODES

In all electron tubes, electrons striking the plate may, if moving at sufficient speed, dislodge other electrons. In two- and three-electrode types, these dislodged electrons usually do not cause trouble because no positive electrode other than the plate itself is present to attract them. These electrons, therefore, are drawn back to the plate. Emission caused by bombardment of an electrode by electrons from the cathode is called **secondary emission** because the effect is secondary to the original cathode emission. In the case of screen-grid tubes, the proximity of the positive screen to the plate offers a strong attraction to these secondary electrons and particularly so if the plate voltage swings lower than the screen voltage. This effect lowers the plate current and limits the permissible plate-voltage swing for tetrodes.

The plate-current limitation is removed when a fifth electrode is placed within the tube between the screen and plate. This fifth electrode is known as the **suppressor** (grid No. 3) and is usually connected to the cathode. Because of its nega-

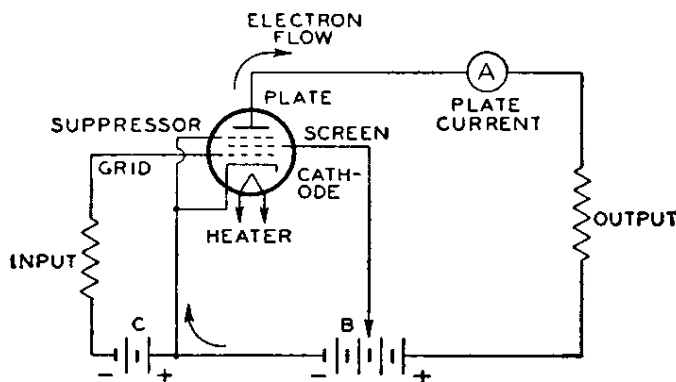

Fig. 8

tive potential with respect to the plate, the suppressor retards the flight of secondary electrons and diverts them back to the plate where they cannot cause trouble. The family name for a five-electrode tube is "pentode". In power-output pentodes, the suppressor makes possible higher power output with lower grid-driving voltage; in radio-frequency amplifier pentodes the suppressor makes possible high voltage amplification at moderate values of plate voltage. These desirable features are due to the fact that the plate-voltage swing can be made very large. In fact, the plate voltage may be as low as, or lower than, the screen voltage without serious loss in signal-gain capability. Representative pentodes used for power amplification are the 3V4 and 6K6-GT; representative pentodes used for voltage amplification are the 1U4, 6SJ7, 12SK7, and 6BA6.

BEAM POWER TUBES

A **beam power tube** is a tetrode or pentode in which directed electron beams are used to increase substantially the power-handling capability of the tube. Such a tube contains a cathode, a control-grid, a screen, a plate, and, optionally, a sup-

pressor grid. When a beam power tube is designed without an actual suppressor, the electrodes are so spaced that secondary emission from the plate is suppressed by space-charge effects between screen and plate. The space charge is produced by the slowing up of electrons traveling from a high-potential screen to a lower potential plate. In this low-velocity region, the space charge produced is sufficient to repel secondary electrons emitted from the plate and to cause them to return to the plate. Beam power tubes of this design employ beam-confining electrodes at cathode potential to assist in producing the desired beam effects and to prevent stray electrons from the plate from returning to the screen outside of the beam. A feature of a beam power tube is its low screen current. The screen and the grid are spiral wires wound so that each turn of the screen is shaded from the cathode by a grid turn. This alignment of the screen and grid causes the electrons to travel in sheets between the turns of the screen so that very few of them strike the screen. Because of the effective suppressor action provided by space charge and because of the low current drawn by the screen, the beam power tube has the advantages of high power output, high power sensitivity, and high efficiency.

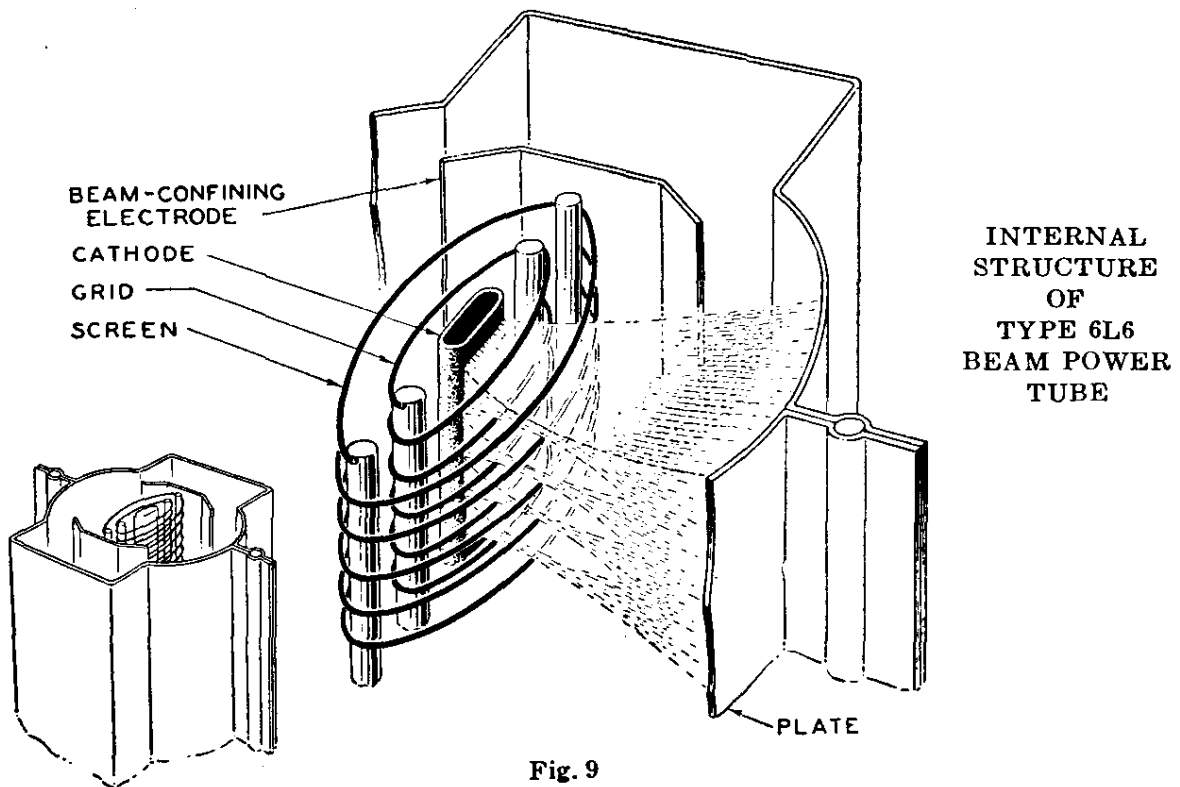

Fig. 9

Fig. 9 shows the structure of a beam power tube employing space-charge suppression and illustrates how the electrons are confined to beams. The beam condition illustrated is that for a plate potential less than the screen potential. The high-density space-charge region is indicated by the heavily dashed lines in the beam. Note that the edges of the beam-confining electrodes coincide with the dashed portion of the beam. In this way the space-charge potential region is extended beyond the beam boundaries and stray secondary electrons are prevented from returning to the screen outside of the beam. The space-charge effect may also be obtained by use of an actual suppressor grid. Examples of beam power tubes are 6L6, 6V6-GT, and 50B5.

MULTI-ELECTRODE and MULTI-UNIT TUBES

Early in the history of tube development and application, tubes were designed for general service; that is, a single tube type—a triode—was used as a radio-frequency amplifier, an intermediate-frequency amplifier, an audio-frequency amplifier, an oscillator, or a detector. Obviously, with this diversity of application, one tube did not meet all requirements to the best advantage.

Later and present trends of tube design are the development of "specialty" types. These types are intended either to give optimum performance in a particular application or to combine in one bulb functions which formerly required two or more tubes. The first class of tubes includes such examples of specialty types as the 6F6, 12SK7, 6L7, and 6K8. Types of this class generally require more than three electrodes to obtain the desired special characteristics and may be broadly classed as multi-electrode types. The 6L7 is an especially interesting type in this class. This tube has an unusually large number of electrodes, namely seven, exclusive of the heater. Plate current in the tube is varied at two different frequencies at the same time. The tube is designed primarily for use as a mixer in superheterodyne receivers. In this use, the tube mixes the signal frequency with the oscillator frequency to give an intermediate-frequency output.

Tubes of the multi-electrode class often present interesting possibilities of application besides the one for which they are primarily designed. The 6L7, for instance, can also be used as a variable-gain audio amplifier in volume-expander and compressor application. The 6F6, besides its use as a power-output pentode, can also be connected as a triode and used as a driver for a pair of 6L6's.

The second class includes multi-unit tubes such as the twin-diode triodes 6BF6 and 6SQ7, as well as the twin-diode pentodes 1F7-G and 12C8 and the twin class A and class B types 12AU7 and 6N7, respectively. In this class also is included the multi-unit type 117N7-GT. This tube combines in one bulb a diode for use as a power rectifier and a power-output pentode. Related to multi-unit tubes are the electron-ray types 6U5/6G5 and 6AB5/6N5. These combine a triode amplifier with a fluorescent target. Full-wave rectifiers are also multi-unit types.

A third class of tubes combines features of each of the other two classes. Typical of this third class are the pentagrid-converter types 1R5, 6BE6, and 6SA7. These tubes are similar to the multi-electrode types in that they have seven electrodes, all of which affect the electron stream; and they are similar to the multi-unit tubes in that they perform simultaneously the double function of oscillator and mixer in superheterodyne receivers.

Complete classification of tubes by services and cathode voltages is given on the chart at the beginning of the TUBE TYPES SECTION.

Electron Tube Characteristics

The term "characteristics" is used to identify the distinguishing electrical features and values of an electron tube. These values may be shown in curve form or they may be tabulated. When given in curve form, they are called characteristic curves and may be used for the determination of tube performance and the calculation of additional tube factors.

Tube characteristics are obtained from electrical measurements of a tube in various circuits under certain definite conditions of voltages. Characteristics may be further described by denoting the conditions of measurements. For example, Static Characteristics are the values obtained with different dc potentials applied to the tube electrodes, while Dynamic Characteristics are the values obtained with an ac voltage on the control grid under various conditions of dc potentials on the electrodes. The dynamic characteristics, therefore, are indicative of the performance capabilities of a tube under actual working conditions.

Static characteristics may be shown by plate characteristics curves and transfer (mutual) characteristics curves. These curves present the same information, but in two different forms to increase its usefulness. The plate characteristic curve is obtained by varying plate voltage and measuring plate current for different control-grid bias voltages, while the transfer-characteristic curve is obtained by

varying control-grid bias voltage and measuring plate current for different plate voltages. A plate-characteristic family of curves is illustrated by Fig. 10. Fig. 11 gives the transfer characteristic family of curves for the same tube.

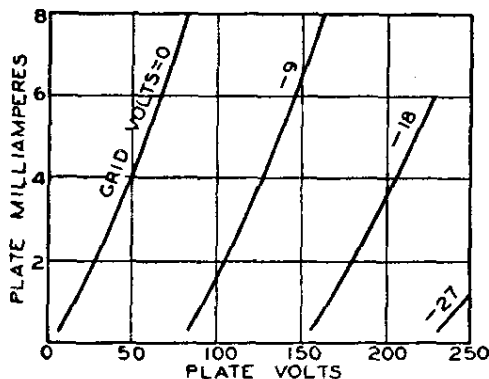

Fig. 10

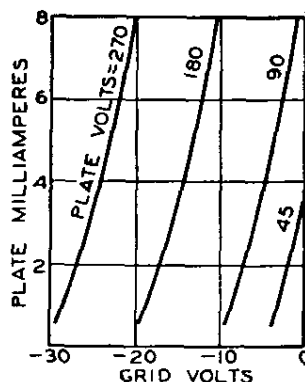

Fig. 11

Dynamic characteristics include amplification factor, plate resistance, control-grid—plate transconductance and certain detector characteristics, and may be shown in curve form for variations in tube operating conditions.

The **amplification factor**, or μ , is the ratio of the change in plate voltage to a change in control-electrode voltage in the opposite direction, under the condition that the plate current remains unchanged, and that all other electrode voltages are maintained constant. For example, if, when the plate voltage is made 1 volt more positive, the grid voltage must be made 0.1 volt more negative to hold plate current unchanged, the amplification factor is 1 divided by 0.1, or 10. In other words, a small voltage variation in the grid circuit of a tube has the same effect on the plate current as a large plate voltage change—the latter equal to the product of the grid voltage change and amplification factor. The μ of a tube is useful for calculating stage gain. This use is discussed in the ELECTRON TUBE APPLICATIONS SECTION.

Plate resistance (r_p) of a radio tube is the resistance of the path between cathode and plate to the flow of alternating current. It is the quotient of a small change in plate voltage divided by the corresponding change in plate current and is expressed in ohms, the unit of resistance. Thus, if a change of 0.1 milliampere (0.0001 ampere) is produced by a plate voltage variation of 1 volt, the plate resistance is 1 divided by 0.0001, or 10000 ohms.

Control-grid—plate transconductance, or simply **transconductance** (g_m), is a factor which combines in one term the amplification factor and the plate resistance, and is the quotient of the first divided by the second. This term is also known as **mutual conductance**. Transconductance may be more strictly defined as the quotient of a small change in plate current (amperes) divided by the small change in the control-grid voltage producing it, under the condition that all other voltages remain unchanged. Thus, if a grid-voltage change of 0.5 volt causes a plate-current change of 1 milliampere (0.001 ampere), with all other voltages constant, the transconductance is 0.001 divided by 0.5, or 0.002 mho. A "mho" is the unit of conductance and was named by spelling ohm backwards. For convenience, a millionth of a mho, or a micromho (μmho), is used to express transconductance. Thus, in the example, 0.002 mho is 2000 micromhos.

Conversion transconductance (g_c) is a characteristic associated with the mixer (first detector) function of tubes and may be defined as the quotient of the intermediate-frequency (if) current in the primary of the if transformer divided by the applied radio-frequency (rf) voltage producing it; or more precisely, it is the limiting value of this quotient as the rf voltage and if current approach zero. When the performance of a frequency converter is determined, conversion transconduct-

ance is used in the same way as control-grid—plate transconductance is used in single-frequency amplifier computations.

The **plate efficiency** of a power amplifier tube is the ratio of the ac power output to the product of the average dc plate voltage and dc plate current at full signal, or

$$\text{Plate efficiency (\%)} = \frac{\text{power output watts}}{\text{average dc plate volts} \times \text{average dc plate amperes}} \times 100$$

The **power sensitivity** of a tube is the ratio of the power output to the square of the input signal voltage (RMS) and is expressed in mhos as follows:

$$\text{Power sensitivity (mhos)} = \frac{\text{power output watts}}{(\text{input signal volts, RMS})^2}$$

Electron Tube Applications

The diversified applications of an electron receiving tube have, within the scope of this section, been treated under eight headings. These are: Amplification, Rectification, Detection, Automatic Volume Control, Tuning Indication with Electron-Ray Tubes, Oscillation, Frequency Conversion, and Automatic Frequency Control. Although these operations may take place at either radio or audio frequencies and may involve the use of different circuits and different supplemental parts, the general considerations of each kind of operation are basic.

AMPLIFICATION

The amplifying action of an electron tube was mentioned under **Triodes** in the section on **ELECTRONS, ELECTRODES, and ELECTRON TUBES**.

This action can be utilized in electronic circuits in a number of ways, depending upon the results desired. Four classes of amplifier service recognized by engineers are covered by definitions standardized by the Institute of Radio Engineers. This classification depends primarily on the fraction of input cycle during which plate current is expected to flow under rated full-load conditions. The classes are class A, class AB, class B, and class C. The term, cutoff bias, used in these definitions is the value of grid bias at which plate current is some very small value.

Class A Amplifier. A class A amplifier is an amplifier in which the grid bias and alternating grid voltages are such that plate current in a specific tube flows at all times.

Class AB Amplifier. A class AB amplifier is an amplifier in which the grid bias and alternating grid voltages are such that plate current in a specific tube flows for appreciably more than half but less than the entire electrical cycle.

Class B Amplifier. A class B amplifier is an amplifier in which the grid bias is approximately equal to the cutoff value so that the plate current is approximately zero when no exciting grid voltage is applied, and so that plate current in a specific tube flows for approximately one-half of each cycle when an alternating grid voltage is applied.

Class C Amplifier. A class C amplifier is an amplifier in which the grid bias is appreciably greater than the cutoff value so that the plate current in each tube is zero when no alternating grid voltage is applied, and so that plate current flows in a specific tube for appreciably less than one-half of each cycle when an alternating grid voltage is applied.

NOTE:—To denote that grid current does not flow during any part of the input cycle, the suffix 1 may be added to the letter or letters of the class identification. The suffix 2 may be used to denote that grid current flows during some part of the cycle.

For radio-frequency amplifiers which operate into a selective tuned circuit, as in radio transmitter applications, or under requirements where distortion is not an important factor, any of the above classes of amplifiers may be used, either with a single tube or a push-pull stage. For audio-frequency amplifiers in which distortion is an important factor, only class A amplifiers permit single-tube operation. In this case, operating conditions are usually chosen so that distortion is kept below the conventional 5% for triodes and the conventional 7 to 10% for tetrodes or pentodes. Distortion can be reduced below these figures by means of special circuit arrangements such as that discussed under **inverse feedback**. With class A amplifiers, reduced distortion with improved power performance can be obtained by using a push-pull stage for audio service. With class AB and class B amplifiers, a balanced amplifier stage using two tubes is required for audio service.

As a class A voltage amplifier, an electron tube is used to reproduce grid voltage variations across an impedance or a resistance in the plate circuit. These variations are essentially of the same form as the input signal voltage impressed on the grid, but of increased amplitude. This is accomplished by operating the tube at a suitable grid bias so that the applied grid-input voltage produces plate-current variations proportional to the signal swings. Since the voltage variation obtained in the plate circuit is much larger than that required to swing the grid, amplification of the signal is obtained. Fig. 12 gives a graphical illustration of this method of amplification and shows, by means of the grid-voltage vs. plate-current characteristics curve, the effect of an input signal (S) applied to the grid of a tube. O is the resulting amplified plate-current variation.

The plate current flowing through the load resistance (R) of Fig. 13 causes a voltage drop which varies directly with the plate current. The ratio of this voltage variation produced in the load resistance to the input signal voltage is the voltage

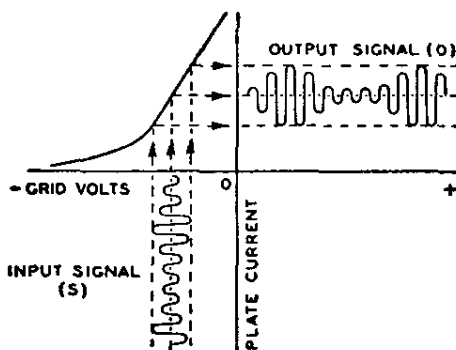

Fig. 12

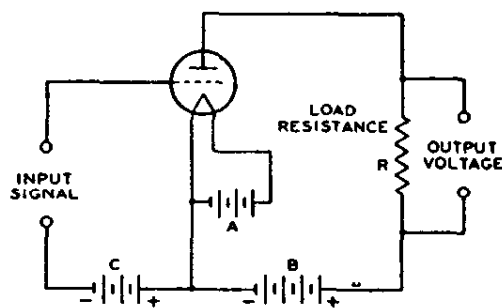

Fig. 13

amplification, or **gain**, provided by the tube. The voltage amplification due to the tube is expressed by the following convenient formulas:

$$\text{Voltage amplification} = \frac{\text{amplification factor} \times \text{load resistance}}{\text{load resistance} + \text{plate resistance}}, \text{ or}$$

$$\frac{\text{transconductance in micromhos} \times \text{plate resistance} \times \text{load resistance}}{1000000 \times (\text{plate resistance} + \text{load resistance})}$$

From the first formula, it can be seen that the gain actually obtainable from the tube is less than the tube's amplification factor but that the gain approaches the amplification factor when the load resistance is large compared to the tube's plate resistance. Fig. 14 shows graphically how the gain approaches the mu of the tube as load resistance is increased. From the curve it can be seen that to obtain high gain in a voltage amplifier, a high value of load resistance should be used.

In a resistance-coupled amplifier, the load resistance of the tube is approximately equal to the resistance of the plate resistor in parallel with the grid resistor of the following stage. Hence, to obtain a large value of load resistance, it is neces-

sary to use a plate resistor and a grid resistor of large resistance. However, the plate resistor should not be too large because the flow of plate current through the plate resistor produces a voltage drop which reduces the plate voltage applied to the tube. If the plate resistor is too large, this drop will be too large, the plate voltage on the tube will be too small, and the voltage output of the tube will be too small. Also, the grid resistor of the following stage should not be too large, the actual maximum value being dependent on the particular tube type. This precaution is necessary because all tubes contain minute amounts of residual gas which cause a minute flow of current through the grid resistor. If the grid resistor is too large, the positive bias developed by the flow of this current through the resistor decreases the normal negative bias and produces an increase in the plate current. This increased current may over-heat the tube and cause liberation of more gas which, in turn, will cause further decrease in bias. The action is cumulative and results in a runaway condition which can destroy the tube. A higher value of grid resistance is permissible when cathode bias is used than when fixed bias is used. When cathode bias is used, a loss in bias due to grid-emission effects is nearly completely offset by an increase in bias due to the voltage drop across the cathode resistor. The recommended values of plate resistor and grid resistor for the tube types used in resistance-coupled circuits, and the values of gain obtainable, are shown in the RESISTANCE-COUPLED AMPLIFIER SECTION.

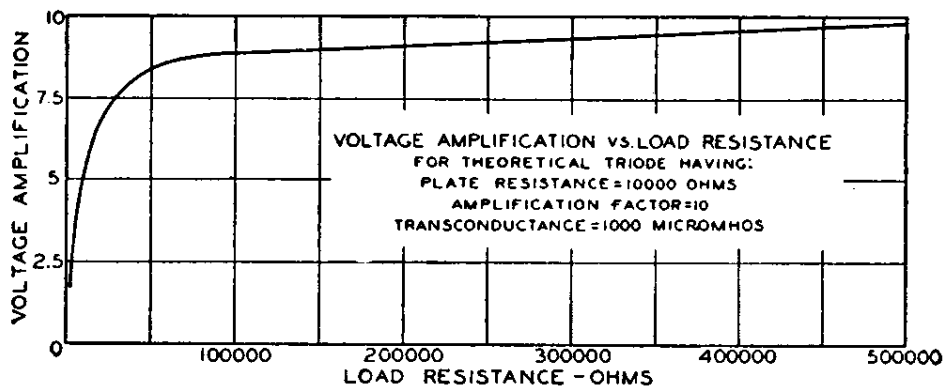

Fig. 14

The **input impedance** of an electron tube, that is, the impedance between grid and cathode is made up of (1) a reactive component due to the capacitance between grid and cathode, (2) a resistive component resulting from the time of transit of electrons between cathode and grid, and (3) a resistive component developed by the part of the cathode lead inductance which is common to both the input and output circuits. Components (2) and (3) are dependent on the frequency of the incoming signal. The input impedance is very high at audio frequencies when a tube is operated with its grid biased negative. Hence, in a class A_1 or class AB_1 transformer-coupled audio amplifier, the loading imposed by the grid on the input transformer is negligible. The secondary impedance of a class A_1 or class AB_1 input transformer can, therefore, be made very high since the choice is not limited by the input impedance of the tube; however, transformer design considerations may limit the choice. At the higher radio frequencies, the input impedance may become very low even when the grid is negative, due to the finite time of passage of electrons between cathode and grid and to the appreciable lead reactance. This impedance drops very rapidly as the frequency is raised and increases input-circuit loading. In fact, the input impedance may become low enough at very high radio frequencies to affect appreciably the gain and selectivity of a preceding stage. Tubes such as the "acorn" types and the high-frequency miniatures have been developed to have low input capacitances, low electron transit time, and low lead inductance so that their input impedance is high even at the ultra-high radio frequencies. **Input admittance** is the reciprocal of input impedance.

A **remote-cutoff amplifier tube** is a modified construction of a pentode or a

tetrode type and is designed to reduce modulation-distortion and cross-modulation in radio-frequency stages. **Cross-modulation** is the effect produced in a radio receiver by an interfering station "riding through" on the carrier of the station to which the receiver is tuned. **Modulation-distortion** is a distortion of the modulated carrier and appears as audio-frequency distortion in the output. This effect is produced by a radio-frequency amplifier stage operating on an excessively curved characteristic when the grid bias has been increased to reduce volume. The offending stage for cross-modulation is usually the first radio-frequency amplifier, while

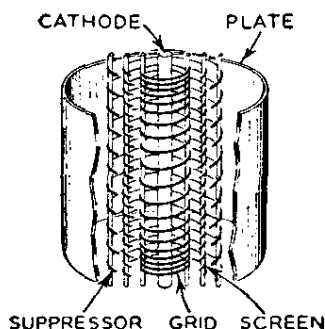

Fig. 15

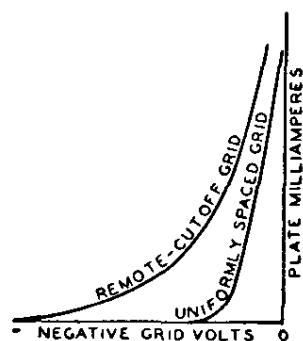

Fig. 16

for modulation-distortion, the cause is usually the last intermediate-frequency stage. The characteristics of remote-cutoff types are such as to enable them to handle both large and small input signals with minimum distortion over a wide range.

Fig. 15 illustrates the construction of the control grid in such a tube. The remote-cutoff action is due to the structure of the grid which provides a variation in amplification factor with change in grid bias. The grid is wound with open spacing at the middle and with close spacing at the ends. When weak signals and low grid bias are applied to the tube, the effect of the non-uniform turn spacing of the grid on cathode emission and tube characteristics is essentially the same as for uniform spacing. As the grid bias is made more negative to handle larger input signals, the electron flow from the sections of the cathode enclosed by the ends of the grid is cut off. The plate current and other tube characteristics are then dependent on the electron flow through the open section of the grid. This action changes the gain of the tube so that large signals may be handled with minimum distortion due to cross-modulation and modulation-distortion. Fig. 16 shows a typical plate-current vs. grid-voltage curve for a remote-cutoff type compared with the curve for a type having a uniformly spaced grid. It will be noted that while the curves are similar at small grid-bias voltages, the plate current of the remote-cutoff tube drops quite slowly with large values of bias voltage. This slow change makes it possible for the tube to handle large signals satisfactorily. Since remote-cutoff types can accommodate large and small signals, they are particularly suitable for use in sets having automatic volume control. Remote-cutoff tubes also are known as variable-mu types. The 6SK7 is a representative remote-cutoff type.

As a **class A power amplifier**, an electron tube is used in the output stage of a radio receiver to supply a relatively large amount of power to the loudspeaker. For this application, large power output is of more importance than high voltage amplification; therefore, gain possibilities are sacrificed in the design of power tubes to obtain power-handling capability. Triodes, pentodes, and beam power tubes designed for power amplifier service have certain inherent features for each structure. Power tubes of the triode type for class A service are characterized by low power sensitivity, low plate-power efficiency, and low distortion. Power tubes of the pentode type are characterized by high power sensitivity, high plate-power efficiency and, usually, somewhat higher distortion than class A triodes. Beam power tubes such as the 6L6 have still higher power sensitivity and efficiency and have higher power-output capability than triode or conventional pentode types.

A class A power amplifier is used also as a driver to supply power to a class AB₂ or a class B stage. It is usually advisable to use a triode, rather than a pentode, in a driver stage because of the lower plate impedance of the triode.

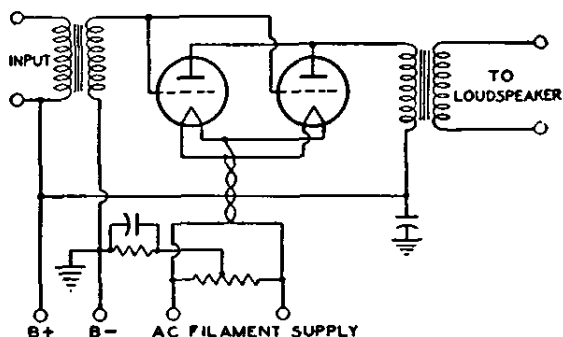

Fig. 17

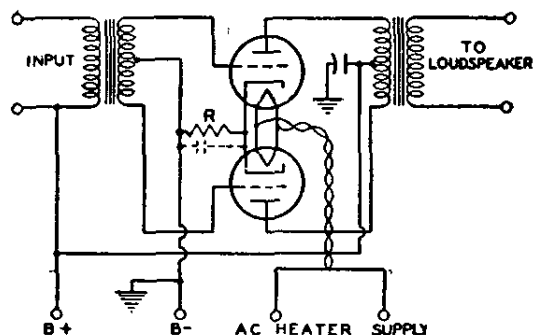

Fig. 18

Power tubes connected in either **parallel** or **push-pull** may be employed as class A amplifiers to obtain increased output. The parallel connection (Fig. 17) provides twice the output of a single tube with the same value of grid-signal voltage. With this connection, the effective transconductance of the stage is doubled, and the effective plate resistance and the load resistance required are halved as compared with single-tube values. The push-pull connection (Fig. 18), although it requires twice the grid-signal voltage, has, in addition to providing increased power, other important advantages over single-tube operation. Distortion caused by even-order harmonics and hum caused by plate-voltage-supply fluctuations are either eliminated or decidedly reduced through cancellation. Since distortion for push-pull operation is less than for single-tube operation, appreciably more than twice single-tube output can be obtained by decreasing the load resistance for the stage to a value approaching the load resistance for a single tube. For either parallel or push-pull class A operation of two tubes, all electrode currents are doubled while all dc electrode voltages remain the same as for single-tube operation. If a cathode resistor is used, its value should be about one-half that for a single tube. Should oscillations occur with either type of connection, they can often be eliminated by connecting a non-inductive resistor of approximately 100 ohms in series with each grid at the socket terminal.

Operation of power tubes so that the grids run positive is inadvisable except under conditions such as those discussed in this section for class AB and class B amplifiers.

Calculation of the **power output of a triode** used as a class A amplifier with either an output transformer or a choke having low dc resistance can be made without serious error from the plate family of curves by assuming a resistance load. The proper plate current, grid bias, optimum load resistance, and the per cent second-harmonic distortion can also be determined. The calculations are made graphically and are illustrated in Fig. 19 for given conditions. The procedure is as follows: (1) Locate the zero-signal bias point P by determining the zero-signal bias E_{c0} from the formula:

$$\text{Zero-signal bias } (E_{c0}) = -(0.68 \times E_b) / \mu$$

where E_b is the chosen value in volts of dc plate voltage at which the tube is to be operated, and μ is the amplification factor of the tube. This quantity is shown as negative to indicate that a negative bias is used. (2) Locate on the plate family the value of zero-signal plate current, I_0 , corresponding to point P. (3) Locate $2I_0$, which is twice the value of I_0 and corresponds to the value of the maximum-signal plate current I_{max} . (4) Locate the point X on the dc bias curve at zero volts, $E_c = 0$, corresponding to the value of I_{max} . (5) Draw a straight line XY through X and P.

Line XY is known as the load resistance line. Its slope corresponds to the value of the load resistance. The load resistance in ohms is equal to $(E_{\max} - E_{\min})$ divided by $(I_{\max} - I_{\min})$, where E is in volts and I is in amperes.

It should be noted that in the case of filament types of tubes, the calculations are given on the basis of a dc-operated filament. When, however, the filament is ac-operated, the calculated value of dc bias should be increased by approximately one-half the filament voltage rating of the tube.

The value of zero-signal plate current I_0 should be used to determine the plate dissipation, an important factor influencing tube life. In a class A amplifier under no-signal conditions, the plate dissipation is equal to the power input, i.e., the product of the dc plate voltage E_0 and the zero-signal dc plate current I_0 . If it is found that the plate-dissipation rating of the tube is exceeded with the zero-signal bias E_{c0} calculated above, it will be necessary to increase the bias by a sufficient amount so that the actual plate dissipation does not exceed the rating before proceeding further with the remaining calculations.

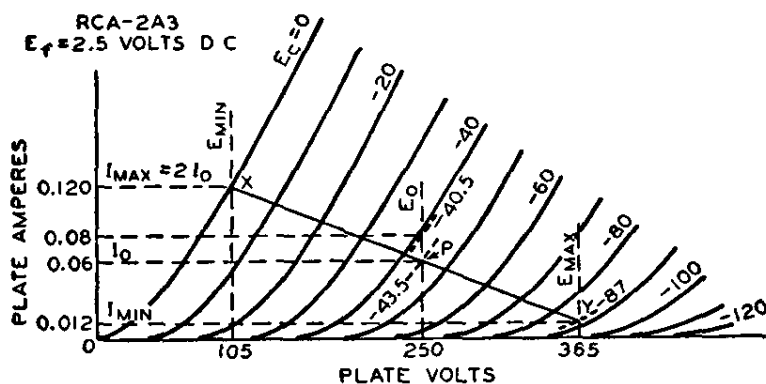

Fig. 19

For power output calculations, it is assumed that the peak alternating grid voltage is sufficient (1) to swing the grid from the zero-signal bias value E_{c0} to zero bias ($E_c = 0$) on the positive swing and (2) to swing the grid to a value twice the zero-signal bias value on the negative swing. During the negative swing, the plate voltage and plate current reach values of E_{\max} and I_{\min} ; during the positive swing, they reach values of E_{\min} and I_{\max} . Since power is the product of voltage and current, the power output as shown by a wattmeter is given by

$$\text{Power output} = \frac{(I_{\max} - I_{\min})(E_{\max} - E_{\min})}{8}$$

where E is in volts, I is in amperes, and power output is in watts.

In the output of power amplifier triodes, some distortion is present. This distortion is due predominantly to second harmonics in single-tube amplifiers. The percentage of second-harmonic distortion may be calculated by the following formula:

$$\% \text{ 2nd-harmonic distortion} = \frac{\frac{I_{\max} + I_{\min}}{2} - I_0}{I_{\max} - I_{\min}} \times 100$$

where I_0 is the zero-signal plate current in amperes. In case the distortion is excessive, the load resistance should be increased or decreased slightly and the calculations repeated.

Example: Determine the load resistance, power output, and distortion of a triode having an amplification factor of 4.2, a plate-dissipation rating of 15 watts, and plate characteristics curves as shown in Fig. 19. The tube is to be operated at 250 volts on the plate.

Procedure: For a first approximation, determine the operating point P from the

zero-signal bias formula, $E_{c_0} = -(0.68 \times 250) / 4.2 = -40.5$ volts. From the curve for this voltage, it is found that the zero-signal plate current I_0 at a plate voltage of 250 volts is 0.08 ampere and, therefore, the plate-dissipation rating is exceeded ($0.08 \times 250 = 20$ watts). Consequently, it is necessary to reduce the zero-signal plate current to 0.06 ampere at 250 volts. The grid bias is now seen to be -43.5 volts. Note that the curve was taken with a dc filament supply; if the filament is to be operated on an ac supply, the bias must be increased by about one-half the filament voltage, or to -45 volts, and the circuit returns made to the mid-point of the filament circuit.

Point X can now be determined. Point X is at the intersection of the dc bias curve at zero volts with I_{max} , where $I_{max} = 2I_0 = 2 \times 0.06 = 0.12$ ampere. Line XY is drawn through points P and X. E_{max} , E_{min} , and I_{min} are then found from the curves. Substituting these values in the power output formula, we obtain

$$\text{Power output} = \frac{(0.12 - 0.012)(365 - 105)}{8} = 3.52 \text{ watts}$$

The resistance represented by load line XY is

$$\frac{(365 - 105)}{(0.12 - 0.012)} = 2410 \text{ ohms}$$

If now the values from the curves are substituted in the distortion formula, we obtain

$$\% \text{ 2nd-harmonic distortion} = \frac{\frac{0.12 + 0.012}{2} - 0.06}{0.12 - 0.012} \times 100 = 5.5\%$$

It is customary to select the load resistance so that the distortion does not exceed five per cent. When the method shown is used to determine the slope of the load resistance line, the second-harmonic distortion generally does not exceed five per cent. In the example, however, the distortion is excessive and it is desirable, therefore, to use a slightly higher load resistance. A load resistance of 2500 ohms will give a distortion of about 4.9 per cent. The power output is reduced only slightly to 3.5 watts.

Operating conditions for **triodes in push-pull** depend on the type of operation desired. Under class A conditions, distortion, power output, and efficiency are all relatively low. The operating bias can be anywhere between that specified for single-tube operation and that equal to one-half the grid-bias voltage required to produce plate-current cutoff at a plate voltage of $1.4E_0$ where E_0 is the operating plate voltage. Higher bias than this value requires higher grid-signal voltage and results in class AB₁ operation which is discussed later.

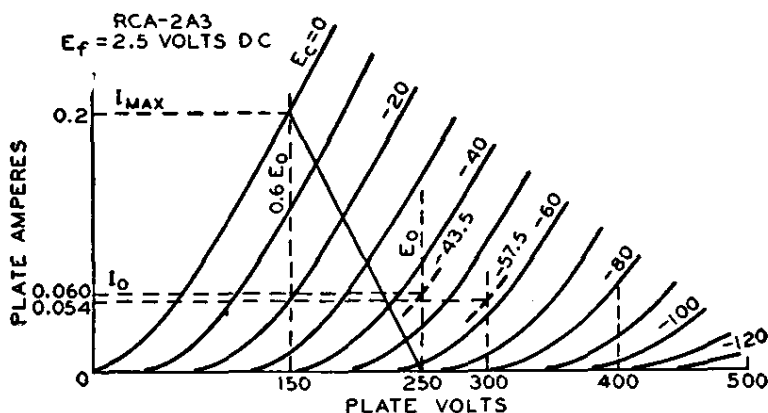

Fig. 20

The method for calculating power output for **triodes in push-pull class A operation** is as follows: Erect a vertical line at $0.6E_0$ (see Fig. 20), intersecting the $E_c = 0$ curve at the point I_{max} . Then, I_{max} is determined from the curve for use in the formula

$$\text{Power output} = (I_{max} \times E_0) / 5.$$

If I_{max} is expressed in amperes and E_o in volts, power output is in watts.

The method for determining the proper load resistance for triodes in push-pull is as follows: Draw a load line through I_{max} on the zero-bias curve and through the E_o point on the zero-current axis. Four times the resistance represented by this load line is the plate-to-plate load for two triodes in a class A push-pull amplifier. Expressed as a formula,

$$\text{Plate-to-plate load } (R_{pp}) = 4 \times (E_o - 0.6E_o) / I_{max}$$

E_o is expressed in volts, I_{max} in amperes, and R_{pp} in ohms.

Example: Assume that the plate voltage (E_o) is to be 300 volts, and the plate dissipation rating of the tube is 15 watts. Then, for class A operation, the operating bias can be equal to, but not more than, one-half the grid bias for cutoff with a plate voltage of $1.4 \times 300 = 420$ volts. (Since cutoff bias is approximately -115 volts at a plate voltage of 420 volts, one-half of this value is -57.5 volts bias.) At this bias, the plate current is found from the plate family to be 0.054 ampere and, therefore, the plate dissipation is 0.054×300 or 16.2 watts. Since -57.5 volts is the limit of bias for class A operation of these tubes at a plate voltage of 300 volts, the dissipation cannot be reduced by increasing the bias and it, therefore, becomes necessary to reduce the plate voltage.

If the plate voltage is reduced to 250 volts, the bias will be found to be -43.5 volts. For this value, the plate current is 0.06 ampere, and the plate dissipation is 15 watts. Then, following the method for calculating power output, erect a vertical line at $0.6E_o = 150$ volts. The intersection of the line with the curve $E_c = 0$ is I_{max} or 0.2 ampere. When this value is substituted in the power formula, the power output is $(0.2 \times 250) / 5 = 10$ watts. The load resistance is determined from the load formula: Plate-to-plate load (R_{pp}) = $4(250 - 150) / 0.2 = 2000$ ohms.

Power output for a pentode or a beam power tube as a class A amplifier can be calculated in much the same way as for triodes. The calculations can be made graphically from a special plate family of curves, as illustrated in Fig. 21.

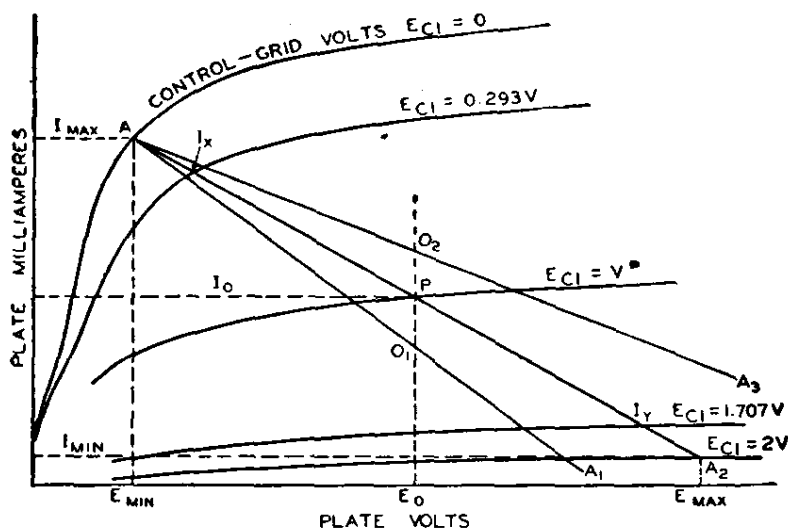

*V is the Negative Control-Grid Bias Voltage at the Operating Point

Fig. 21

From a point A just above the knee of the zero-bias curve, draw arbitrarily selected load lines to intersect the zero-plate-current axis. These lines should be on both sides of the operating point P whose position is determined by the desired operating plate voltage E_o , and one-half the maximum-signal plate current. Along any load line, say AA₁, measure the distance AO₁. On the same line, lay off an equal distance O₁A₁. For optimum operation, the change in bias from A to O₁ should be nearly equal to the change in bias from O₁ to A₁. If this condition can not

be met with one line, as is the case for the line first chosen, then, another should be chosen. When the most satisfactory line has been selected, its resistance may be determined by the following formula:

$$\text{Load resistance } (R_p) = \frac{E_{\max} - E_{\min}}{I_{\max} - I_{\min}}$$

The value of R_p may then be substituted in the following formula for calculating power output.

$$\text{Power output} = \frac{[I_{\max} - I_{\min} + 1.41 (I_x - I_y)]^2 R_p}{32}$$

In both of these formulas, I is in amperes, E is in volts, R_p is in ohms, and power output is in watts. I_x and I_y are the current values on the load line at bias voltages of $E_{c1} = V - 0.707V = 0.293V$ and $E_{c1} = V + 0.707V = 1.707V$, respectively.

Calculations for distortion may be made by means of the following formulas. The terms used have already been defined.

$$\% \text{ 2nd-harmonic distortion} = \frac{I_{\max} + I_{\min} - 2 I_o}{I_{\max} - I_{\min} + 1.41 (I_x - I_y)} \times 100$$

$$\% \text{ 3rd-harmonic distortion} = \frac{I_{\max} - I_{\min} - 1.41 (I_x - I_y)}{I_{\max} - I_{\min} + 1.41 (I_x - I_y)} \times 100$$

$$\% \text{ total (2nd and 3rd) harmonic distortion} = \sqrt{(\%2\text{nd})^2 + (\%3\text{rd})^2}$$

The conversion curves given in Fig. 22 apply to electron tubes in general but are particularly useful for power tubes. These curves can be used for calculating approximate operating conditions for a plate voltage which is

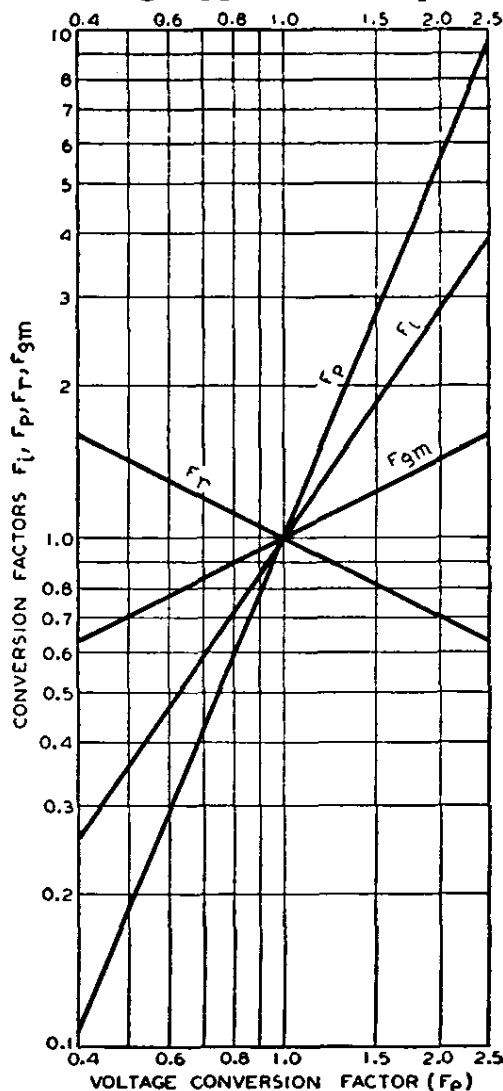

Fig. 22

not included in the published data on operating conditions. For instance, suppose it is desired to operate two 6L6's in class A_1 push-pull, fixed bias, with a plate voltage of 200 volts. The nearest published operating conditions for this class of service are for a plate voltage of 250 volts. The operating conditions for the new plate voltage can be determined as follows: First compute the ratio of the new plate voltage to the plate voltage of the published data. In the example, this ratio is $200/250 = 0.8$. This figure is the Voltage Conversion Factor, F_e . Multiply by this factor the published values for 250-volt operation in order to obtain the new values of grid bias and screen voltage. This gives a grid bias of $-16 \times 0.8 = -12.8$ volts, and a screen voltage of $250 \times 0.8 = 200$ volts for the new conditions.

To obtain the rest of the new conditions, multiply the published values by factors shown on the chart as corresponding to the voltage conversion factor of 0.8. In this chart,

F_1 applies to plate current and to screen current,

F_p applies to power output

F_r applies to load resistance and plate resistance,

F_{gm} applies to transconductance.

Thus, to find the power output for the new conditions, determine the value of F_p for a

voltage conversion factor of 0.8. The chart shows that this value of F_p is 0.6. Multiplying the published value of power output by 0.6, the power output for the new conditions is $14.5 \times 0.6 = 8.7$ watts.

A class AB power amplifier employs two tubes connected in push-pull with a higher negative grid bias than is used in a class A stage. With this higher negative bias, the plate and screen voltages can usually be made higher than for class A because the increased negative bias holds plate current within the limit of the tube's plate-dissipation rating. As a result of these higher voltages, more power output can be obtained from class AB operation.

Class AB amplifiers are subdivided into class AB₁ and class AB₂. In class AB₁ there is no flow of grid current. That is, the peak signal voltage applied to each grid is not greater than the negative grid-bias voltage. The grids therefore are not driven to a positive potential and do not draw grid current. In class AB₂, the peak signal voltage is greater than the bias so that the grids are driven positive and draw grid current.

Because of the flow of grid current in a class AB₂ stage there is a loss of power in the grid circuit. The sum of this loss and the loss in the input transformer is the total driving power required by the grid circuit. The driver stage should be capable of a power output considerably larger than this required power in order that distortion introduced in the grid circuit be kept low. The input transformer used in a class AB₂ amplifier usually has a step-down turns ratio.

Because of the large fluctuations of plate current in a class AB₂ stage, it is important that the plate power supply should have good regulation. Otherwise the fluctuations in plate current cause fluctuations in the voltage output of the power supply, with the result that power output is decreased and distortion is increased. To obtain satisfactory regulation it is usually advisable to use a low-drop rectifier, such as the 5V4-G, with a choke-input filter. In all cases, the resistance of the filter choke and power transformers should be as low as possible.

In class AB₁ push-pull amplifier service using triodes, the operating conditions may be determined graphically by means of the plate family if E_o , the desired operating plate voltage, is given. In this service, the dynamic load line does not pass through the operating point P as in the case of the single-tube amplifier, but through the point D in Fig. 23. Its position is not affected by the operating grid bias provided the plate-to-plate load resistance remains constant. Under these conditions, grid bias has only a small effect on the power output. Grid bias cannot be neglected, however, since it is used to find the zero-signal plate current and, from it, the zero-signal plate dissipation. Since the grid bias is higher in class AB₁ than in class A service for the same plate voltage, this "overbiased" condition permits the use of a higher signal voltage without grid current being drawn and, therefore, higher power output is obtained than in class A service.

In general, for any load line through point D, Fig. 23, the plate-to-plate load resistance in ohms of a push-pull amplifier is $R_{pp} = 4E_o/I'$, where I' is the plate current value in amperes at which the load line as projected intersects the plate current axis and E_o is in volts. This is another form of the formula, given under push-pull class A amplifiers, $R_{pp} = 4(E_o - 0.6E_o)/I_{max}$, but is more general. Power output = $(I_{max}/\sqrt{2})^2 \times R_{pp}/4$, where I_{max} is the peak plate current at zero grid volts for the load chosen. This formula simplified is $(I_{max})^2 \times R_{pp}/8$. The maximum-signal average plate current is $2I_{max}/\pi$ or $0.636 I_{max}$; the maximum-signal average power input is $0.636 I_{max} E_o$.

It is desirable to simplify these formulas for a first approximation. This simplification can be made if it is assumed that the peak plate current, I_{max} , occurs at the point of the zero-bias curve corresponding approximately to $0.6E_o$. The simplified formulas are:

$$\text{Power output (for two tubes)} = (I_{\max} \times E_o)/5$$

$$\text{Plate-to-plate load resistance } (R_{pp}) = 1.6E_o/I_{\max}$$

where E_o is in volts, I_{\max} is in amperes, R_{pp} is in ohms, and power output is in watts.

It may be found during subsequent calculations that the distortion or the plate dissipation is excessive for this approximation; in that case, a different load resistance must be selected using the first approximation as a guide and the process repeated to obtain satisfactory operating conditions.

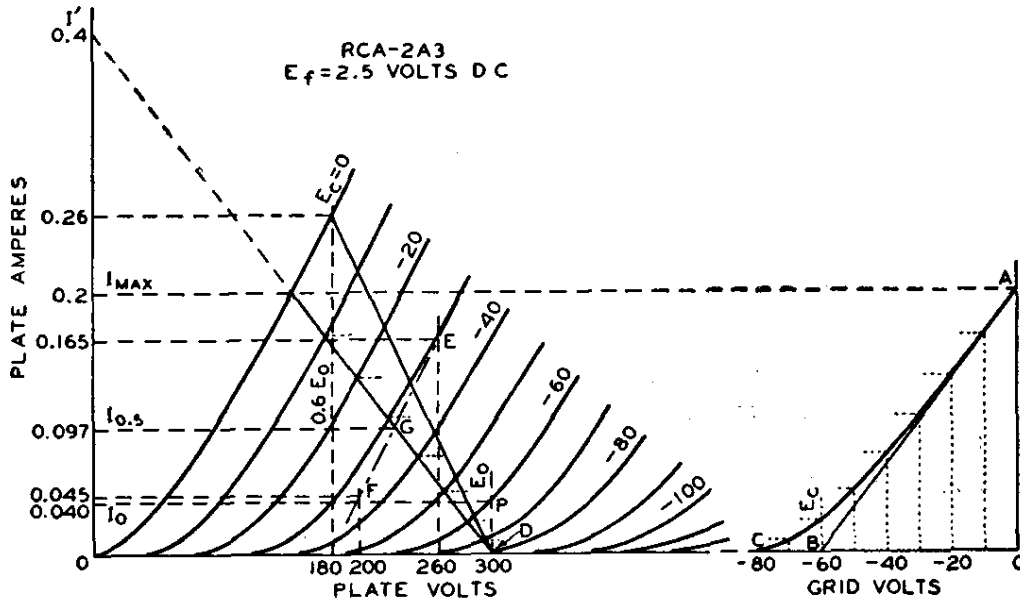

Fig. 23

Fig. 24

Example: Fig. 23 illustrates the application of the method to a pair of 2A3's operated at $E_o = 300$ volts. The tubes have a plate-dissipation rating each of 15 watts. The method is to erect a vertical line at $0.6E_o$, or at 180 volts, which intersects the $E_c = 0$ curve at the point $I_{\max} = 0.26$ ampere. Using the simplified formulas, we obtain

$$\text{Plate-to-plate load resistance } (R_{pp}) = (1.6 \times 300)/0.26 = 1845 \text{ ohms}$$

$$\text{Power output} = (0.26 \times 300)/5 = 15.6 \text{ watts}$$

At this point, it is well to determine the plate dissipation and to compare it with the maximum rated value. From the average plate current formula ($0.636 I_{\max}$) mentioned previously, the maximum-signal average plate current is 0.166 ampere. The product of this current and the operating plate voltage is 49.8 watts, the average input to the two tubes. From this value, subtract the power output of 15.6 watts to obtain the total dissipation for both tubes which is 34.2 watts. Half of this value, 17 watts, is in excess of the 15-watt rating of the tube and it is necessary, therefore, to assume another and higher load resistance so that the plate-dissipation rating will not be exceeded.

It will be found that at an operating plate voltage of 300 volts, the 2A3's require a plate-to-plate load resistance of 3000 ohms. From the formula for R_{pp} , the value of I' is found to be 0.4 ampere. The load line for the 3000-ohm load resistance is then represented by a straight line from the point $I' = 0.4$ ampere on the plate-current ordinate to the point $E_o = 300$ volts on the plate-voltage abscissa. At the intersection of the load line with the zero-bias curve, the peak plate current, I_{\max} , can be read at 0.2 ampere. Then

$$\text{Power output} = (I_{\max}/\sqrt{2})^2 R_{pp}/4 = (0.2/1.41)^2 \cdot 3000/4 = 15 \text{ watts}$$

Proceeding as in the first approximation, we find that the maximum-signal average plate current, $0.636 I_{\max}$, is 0.127 ampere, and the maximum-signal average power input is 38.1 watts. This input minus the power output is $38.1 - 15 = 23.1$ watts.

This is the dissipation for two tubes; the value per tube is 11.6 watts, a value well within the rating of this tube type. •

The operating bias and the zero-signal plate current may now be found by use of a curve which is derived from the plate family and the load line. Fig. 24 is a curve of instantaneous values of plate current and dc grid-bias voltages taken from Fig. 23. Values of grid bias are read from each of the grid-bias curves of Fig. 23 along the load line and are transferred to Fig. 24 to produce the curved line from A to C. A tangent to this curve, starting at A, is drawn to intersect the grid-voltage abscissa. The point of intersection, B, is the operating grid bias for fixed-bias operation. In the example, the bias is -60 volts. Refer back to the plate family at the operating conditions of plate volts = 300 and grid bias = -60 volts; the zero-signal plate current per tube is seen to be 0.04 ampere. This procedure locates the operating point for each tube at P. The plate current must be doubled, of course, to obtain the zero-signal plate current for both tubes. Under maximum-signal conditions, the signal voltage swings from zero-signal bias voltage to zero bias for each tube on alternate half cycles. Hence, in the example, the peak of signal voltage per tube is 60 volts, or the grid-to-grid value is 120 volts.

As in the case of the push-pull class A amplifier, the second-harmonic distortion in a class AB₁ amplifier using triodes is very small and is largely cancelled by virtue of the push-pull connection. Third-harmonic distortion, however, which may be larger than permissible, can be found by means of composite characteristic curves. A complete family of curves can be plotted, but for the present purpose only the one corresponding to a grid bias of one-half the peak grid-voltage swing is needed. In the example, the peak grid voltage per tube is 60 volts, and the half value is 30 volts. The composite curve, since it is nearly a straight line, can be constructed with only two points (see Fig. 23). These two points are obtained from deviations above and below the operating grid and plate voltages. In order to find the curve for a bias of -30 volts, we have assumed a deviation of 30 volts from the operating grid voltage of -60 volts. Next assume a deviation from the operating plate voltage of, say, 40 volts. Then at 300 - 40 = 260 volts, erect a vertical line to intersect the (-60) - (-30) = -30-volt bias curve and read the plate current at this intersection which is 0.167 ampere; likewise, at the intersection of a vertical line at 300 + 40 = 340 volts and the (-60) + (-30) = -90-volt bias curve, read the plate current. In this example, the plate current is estimated to be 0.002 ampere. The difference of 0.165 ampere between these two currents determines the point E on the 300 - 40 = 260-volt vertical. Similarly, another point F on the same composite curve is found by assuming the same grid-bias deviation but a larger plate-voltage deviation, say, 100 volts. We now have points at 260 volts and 0.165 ampere (E), and at 200 volts and 0.45 ampere (F). A straight line through these points is the composite curve for a bias of -30 volts, shown as a long-short dash line in Fig. 23. At the intersection of the composite curve and the load line, G, the instantaneous composite plate current at the point of one-half the peak signal swing is determined. This current value, designated I_{0.5} and the peak plate current, I_{max}, are used in the following formula to find peak value of the third-harmonic component of the plate current.

$$I_{h_3} = (2I_{0.5} - I_{\max})/3$$

In the example, where I_{0.5} is 0.097 ampere and I_{max} is 0.2 ampere, $I_{h_3} = (2 \times 0.097 - 0.2)/3 = (0.194 - 0.2)/3 = -0.006/3 = -0.002$ ampere. (The fact that I_{h₃} is negative indicates that the phase relation of the fundamental (first-harmonic) and third-harmonic components of the plate current is such as to result in a slightly peaked wave form. I_{h₃} is positive in some cases, indicating a flattening of the wave form.)

The peak value of the fundamental or first-harmonic component of the plate current

$$I_{h1} = 2/3 (I_{max} + I_{0.5})$$

In the example: $I_{h1} = 2/3 (0.2 + 0.097) = 0.198$ ampere. Then, the percentage of third-harmonic distortion is $(I_{h3}/I_{h1}) 100 = (0.002/0.198)100 = 1\%$ approx.

A class **AB₂** amplifier employs two tubes connected in push-pull as in the case of class **AB₁** amplifiers. It differs in that it is biased so that plate current flows somewhat more than half the electrical cycle but less than the full cycle, the peak signal voltage is greater than the dc bias voltage, grid current is drawn, and consequently, power is consumed in the grid circuit. These conditions permit obtaining high power output without excessive plate dissipation.

The sum of the power used in the grid circuit and the losses in the input transformer is the total driving power required by the grid circuit. The driver stage should be capable of a power output considerably larger than this required power in order that distortion introduced in the grid circuit be kept low. In addition, the internal impedance of the driver stage as reflected into or as effective in the grid circuit of the power stage should always be as low as possible in order that distortion may be kept low. The input transformer used in a class **AB₂** stage usually has a step-down ratio adjusted for this condition.

Load resistance, plate dissipation, power output, and distortion determinations are similar to those for class **AB₁**. These quantities are interdependent with peak grid-voltage swing and driving power; a satisfactory set of operating conditions involves a series of approximations. The load resistance and signal swing are limited by the permissible grid current and power, and the distortion. With either a high load resistance or excessive signal swing, the plate-dissipation rating will be exceeded, distortion will be high, and the driving power will be unnecessarily high.

A class **B** amplifier employs two tubes connected in push-pull, so biased that plate current is almost zero when no signal voltage is applied to the grids. Because of this low value of no-signal plate current, class **B** amplification has the same advantage as class **AB₂**, i.e., large power output can be obtained without excessive plate dissipation. The difference between class **B** and class **AB₂** is that, in class **B**, plate current is cut off for a larger portion of the negative grid swing, and the signal swing is even larger than in class **AB₂** operation.

Because a class **B** amplifier is usually operated at zero or low bias, each grid is at a positive potential during all or most of the positive half-cycle of its signal swing and consequently draws considerable grid current. There is, therefore, a loss of power in the grid circuit. This condition imposes the same requirement in the driver stage as in a class **AB₂** stage, that is, the driver should be capable of delivering considerably more power output than the power required for the class **B** grid circuit in order that distortion be low. Likewise, the interstage transformer between the driver and class **B** stage usually has a step-down turns ratio.

Determination of load resistance, plate dissipation, power output, and distortion is similar to that for a class **AB₂** stage.

Power amplifier tubes designed for class **A** operation can be used in class **AB₂** and class **B** service under suitable operating conditions. There are several tube types designed especially for class **B** service. The characteristic common to all of these types is a high amplification factor. With a high amplification factor, plate current is small even when the grid bias is zero. These tubes, therefore, can be operated in class **B** service at a bias of zero volts so that no bias supply is required. A number of class **B** amplifier tubes consist of two triode units mounted in one tube. The two units can be connected in push-pull so that only one tube is required for a class **B** stage. Examples of twin triodes used in class **B** service are the 6N7, 6A6, and 1G6-GT.

An **inverse-feedback** circuit, sometimes called a **degenerative** circuit, is one

in which a portion of the output voltage of a tube is applied to the input of the same or a preceding tube in opposite phase to the signal applied to the tube. Two important advantages of feedback are: (1) reduced distortion from each stage included in the feedback circuit and (2) reduction in the variations in gain due to changes in line voltage, possible differences between tubes of the same type, or variations in the values of circuit constants included in the feedback circuit.

Inverse feedback is used in audio amplifiers to reduce distortion in the output stage where the load impedance on the tube is a loudspeaker. Because the impedance of a loudspeaker is not constant for all audio frequencies, the load impedance on the output tube varies with frequency. When the output tube is a pentode or beam power tube having high plate resistance, this variation in plate load impedance can, if not corrected, produce considerable frequency distortion. Such frequency distortion can be reduced by means of inverse feedback. Inverse feedback circuits are of the *constant-voltage* type and the *constant-current* type.

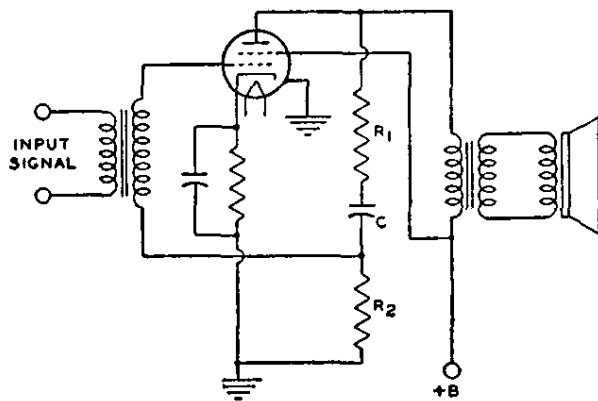

Fig. 25

The application of the *constant-voltage* type of inverse feedback to a power output stage using a single beam power tube is illustrated by Fig. 25. In this circuit, R_1 , R_2 , and C are connected across the output of the 6L6 as a voltage divider. The secondary of the grid-input transformer is returned to a point on this voltage divider. Capacitor C blocks the dc plate voltage from the grid. However, a portion of the tube's af output voltage, approximately equal

to the output voltage multiplied by the fraction $R_2/(R_1 + R_2)$, is applied to the grid. A decrease in distortion results which is explained in the curves of Fig. 26.

Consider first the amplifier without the use of inverse feedback. Suppose that when a signal voltage e_s is applied to the grid the af plate current i'_p has an irregularity in its positive half-cycle. This irregularity represents a departure from the waveform of the input signal and is, therefore, distortion. For this plate-current waveform, the af plate voltage has a waveform shown by e'_p . The plate-voltage waveform is inverted compared to the plate-current waveform because a plate-current increase produces an increase in the drop across the plate load. The voltage at the plate is the difference between the drop across the load and the supply voltage; thus, when plate current goes up, plate voltage goes down; when plate current goes down, plate voltage goes up.

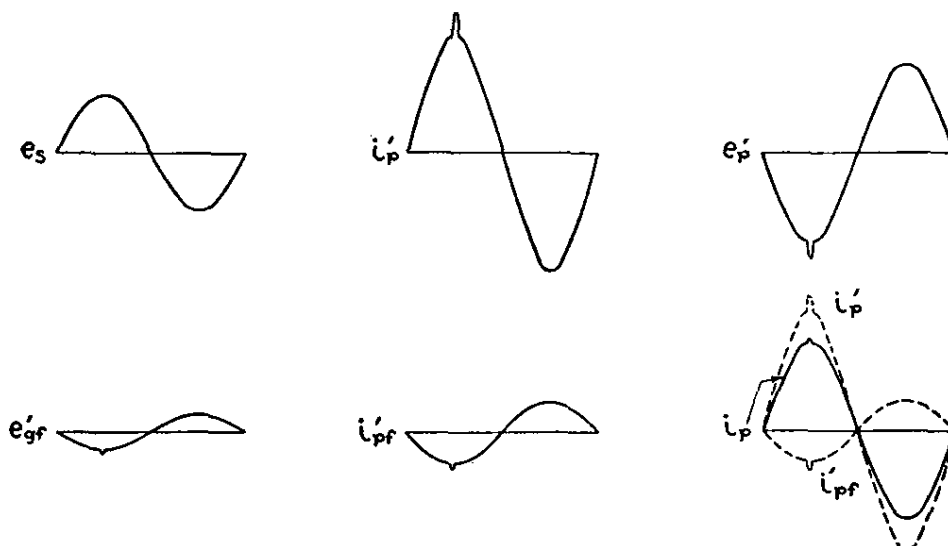

Fig. 26

Now suppose that inverse feedback is applied to the amplifier. The voltage fed back to the grid has the same waveform and phase as the plate voltage, but is smaller in magnitude. Hence, with a plate voltage of waveform shown by e'_p , the feedback voltage appearing on the grid is as shown by e'_{gt} . This voltage applied to the grid produces a component of plate current i'_{pt} . It is evident that the irregularity in the waveform of this component of plate current would act to cancel the original irregularity and thus reduce distortion.

After the correction of distortion has been applied by inverse feedback, the relations are as shown in the curve for i_p . The dotted curve shown by i'_{pt} is the component of plate current due to the feedback voltage on the grid. The dotted curve shown by i'_p is the component of plate current due to the signal voltage on the grid. The algebraic sum of these two components gives the resultant plate current shown by the solid curve of i_p . Since i'_p is the plate current that would flow without inverse feedback, it can be seen that the application of inverse feedback has reduced the irregularity in the output current. In this manner inverse feedback acts to correct any component of plate current that does not correspond to the input signal voltage, and thus reduces distortion.

From the curve for i_p , it can be seen that, besides reducing distortion, inverse feedback also reduces the amplitude of the output current. Consequently, when inverse feedback is applied to an amplifier there is a decrease in power output as well as a decrease in distortion. However, by increasing the signal voltage, it is practical to bring the power output back to its full value. Hence, the application of inverse feedback to an amplifier requires that more driving voltage be applied to obtain full power output but this output is obtained with less distortion.

Inverse feedback may also be applied to resistance-coupled stages as shown in Fig. 27. The circuit is conventional except that a feedback resistor, R_3 , is connected between the plate of tubes T_1 and T_2 . The output signal voltage of T_1 and a portion of the output signal voltage of T_2 appears across R_2 . Because the distortion generated in the plate circuit of T_2 is applied to its grid out of phase with the input signal, the distortion in the output of T_2 is comparatively low. With sufficient inverse feedback of the constant-voltage type in a power-output stage, it is not necessary to employ a network of resistance and capacitance in the output circuit to reduce response at high audio frequencies. Inverse-feedback circuits can also be applied to push-pull class A and class AB_1 amplifiers. When the circuit in Fig. 25 is used in push-pull, the input transformer must have a separate secondary for each grid. Inverse feedback is not recommended for use in amplifiers drawing grid power because of the resistance introduced in the grid circuit.

Constant-current inverse feedback is usually obtained by omitting the bypass capacitor across a cathode resistor. This method decreases the gain and the distortion but increases the plate resistance of the tube. When the plate resistance of an output tube is increased, the output voltage rises at the resonant frequency of the loudspeaker and accentuates hang-over effects.

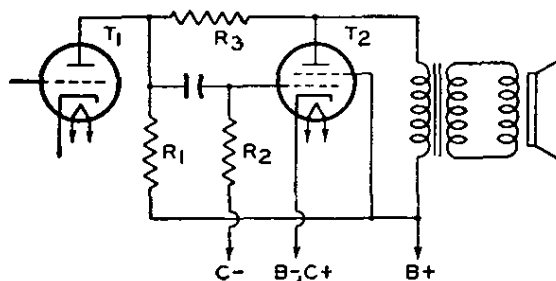

Fig. 27

Inverse feedback is not generally applied to a triode power amplifier, such as the 2A3, because the variation in speaker impedance with frequency does not produce much distortion in a triode stage having low plate resistance. It is sometimes applied in a pentode stage but is not always convenient. As has been shown, when inverse feedback is used in an amplifier, the driving voltage must be increased in order to give full power output.

When inverse feedback is used with a pentode, the total driving voltage required for full power output may be inconveniently large. Because a beam power tube gives full power output on a comparatively small driving voltage, inverse feedback is especially applicable to beam power tubes. By means of inverse feedback, the high efficiency and high power output of beam power tubes can be combined with freedom from the effects of varying speaker impedance.

A corrective filter can be used to improve the frequency characteristic of an output stage using a beam power tube or a pentode when inverse feedback is not applicable. The filter consists of a resistor and a capacitor connected in series across the primary of the output transformer. Connected in this way, the filter is in parallel with the plate load impedance reflected from the voice-coil by the output transformer. The magnitude of this reflected impedance increases with increasing frequency in the middle and upper audio range. The impedance of the filter, however, decreases with increasing frequency. It follows that by use of the proper values for the resistance and the capacitance in the filter, the effective load impedance on the output tubes can be made practically constant for all frequencies in the middle and upper audio range. The result is an improvement in the frequency characteristic of the output stage.

The resistance to be used in the filter for a push-pull stage is 1.3 times the recommended plate-to-plate load resistance; or, for a single-tube stage, is 1.3 times the recommended plate load resistance. The capacitance in the filter should have a value such that the voltage gain of the output stage at a frequency of 1000 cycles or higher is equal to the voltage gain at 400 cycles. A method of determining the proper value of capacitance for the filter is to make two measurements on the

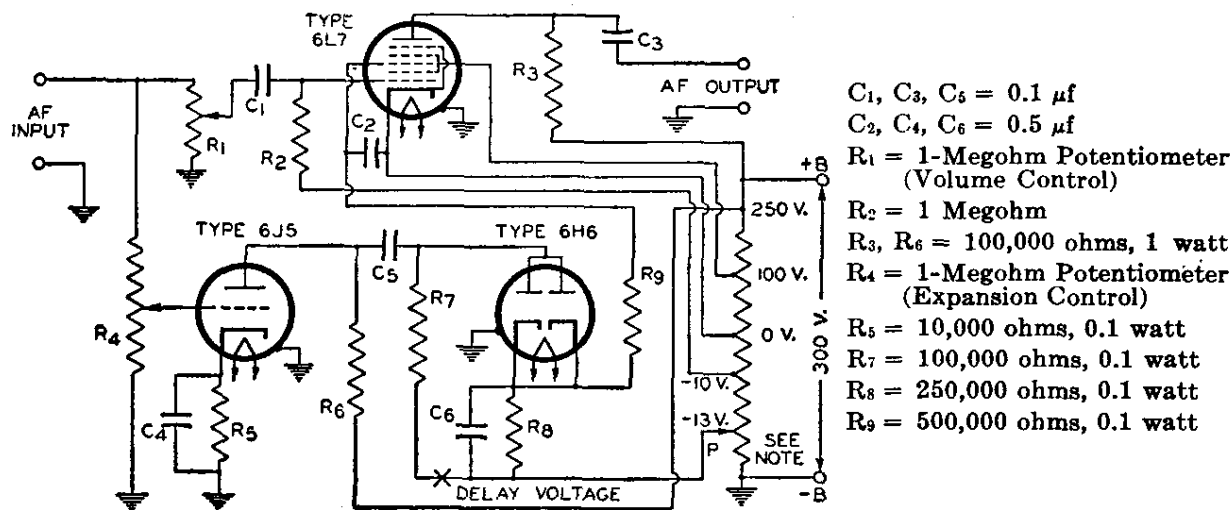

Fig. 28

output voltage across the primary of the output transformer: first, when a 400-cycle signal is applied to the input, and second, when a 100-cycle signal of the same voltage as the 400-cycle signal is applied to the input. The correct value of capacitance is the one which gives equal output voltages for the two signal inputs. In practice, this value is usually found to be in the order of $0.05 \mu\text{f}$.

A volume expander can be used in a phonograph amplifier to make more natural the reproduction of music which has a very large volume range. For instance, in the music of a symphony orchestra, the sound intensity of the loud passages is very much higher than that of the soft passages. When this music is recorded, it is not feasible to make the ratio of maximum amplitude to minimum amplitude as large on the record as it is in the original music. The recording process is therefore monitored so that the volume range of the original is compressed on the record. To compensate for this compression, a volume-expander amplifier has a variable gain which is greater for a high-amplitude signal than for a low-amplitude signal. The volume expander, therefore, amplifies loud passages more than soft

passages and thus can restore to the music reproduced from the record the volume range of the original.

A volume expander circuit is shown in Fig. 28. In this circuit, the gain of the 6L7 as an audio amplifier can be varied by changing the bias on grid No. 3. When the bias on grid No. 3 is made less negative, the gain of the 6L7 increases. The signal to be amplified is applied to grid No. 1 of the 6L7 and is amplified by the 6L7. The signal is also applied to the grid of the 6J5, is amplified by the 6J5, and is rectified by the 6H6. The rectified voltage developed across R_8 , the load resistor of the 6H6, is applied as a positive bias voltage to grid No. 3 of the 6L7. Then, when the amplitude of the signal input increases, the voltage across R_8 increases, and the bias on grid No. 3 of the 6L7 is made less negative. Because this reduction in bias increases the gain of the 6L7, the gain of the amplifier increases with increase in signal amplitude and thus produces volume expansion of the signal. The voltage gain of the expander varies from 5 to 20.

Grid No. 1 of the 6L7 is a variable-mu grid and, therefore, will produce distortion if the input signal voltage is too large. For that reason, the signal input to the 6L7 should not exceed a peak value of 1 volt. This value is of the same order as the voltage obtainable from a magnetic phonograph pick-up. The no-signal bias voltage on grid No. 3 is controlled by adjustment of contact P. This contact should be adjusted initially to give a no-signal plate current of 0.15 milliamperes in the 6L7. No further adjustment of contact P is required if the same 6L7 is always used. If it is desired to delay volume expansion until the signal input reaches a certain amplitude, the delay voltage can be inserted as a negative bias on the 6H6 plates at the point marked X in the diagram. All terminal points on the power-supply voltage divider should be adequately bypassed.

A phase inverter is a circuit used to provide resistance coupling between the output of a single-tube stage and the input of a push-pull stage. The necessity for a phase inverter arises because the signal-voltage inputs to the grids of a push-pull stage must be 180 degrees out of phase and approximately equal in amplitude with respect to each other. Thus, when the signal voltage input to a push-pull stage swings the control grid of one tube in a positive direction, it should swing the other grid in a negative direction by a similar amount. With transformer coupling between stages, the out-of-phase input voltage to the push-pull stage is supplied by means of the center-tapped secondary. With resistance coupling, the out-of-phase input voltage is obtained by means of the inverter action of a tube.

Fig. 29 shows a push-pull power amplifier, resistance-coupled by means of a phase-inverter circuit to a single-stage triode T_1 . Phase inversion in this circuit is provided by triode T_2 . The output voltage of T_1 is applied to the grid of T_3 . A portion of the output voltage of T_1 is also applied through the resistors R_3 and R_5 to the grid of T_2 . The output voltage of T_2 is applied to the grid of T_4 . When the output voltage of T_1 swings in the positive direction, the plate current of T_2 increases. This action increases the voltage drop across the plate resistor R_2 and swings the plate of T_2 in the negative direction. Thus, when the output voltage of T_1 swings positive, the output voltage of T_2 swings negative and is, therefore, 180° out of phase with the output voltage of T_1 . In order to obtain equal voltages at E_a and E_b , $(R_3 + R_5) / R_5$ should equal the voltage gain of T_2 . Under the conditions where a twin-type tube or two

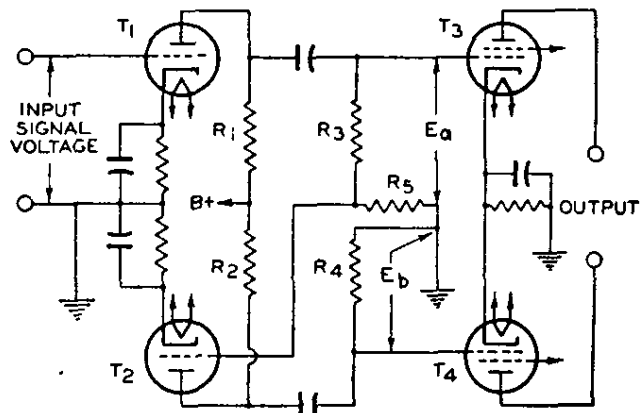

Fig. 29

tubes having the same characteristics are used at T_1 and T_2 , R_4 should be equal to the sum of R_3 and R_5 . The ratio of $R_3 + R_5$ to R_5 should be the same as the voltage gain ratio of T_2 in order to apply the correct value of signal voltage to T_2 . The value of R_5 is, therefore, equal to R_4 divided by the voltage gain of T_2 ; R_3 is equal to R_4 minus R_5 . Values of R_1 , R_2 , R_3 plus R_5 , and R_4 may be taken from the chart in the RESISTANCE-COUPLED AMPLIFIER SECTION. In the practical application of this circuit, it is convenient to use a twin-triode tube combining T_1 and T_2 . A phase-inverter circuit using a 12SC7 is shown in the CIRCUIT SECTION.

An amplifier may also be used as a limiter. One use of a limiter is in receivers designed for the reception of frequency-modulated signals. The limiter in FM receivers has the function of eliminating amplitude variations from the input to the detector. Because in an FM system, amplitude variations are primarily the result of noise disturbances, the use of a limiter prevents such disturbances from being reproduced in the audio output. The limiter usually follows the last if stage where it can minimize the effects of disturbances coming in on the rf carrier and those produced locally.

The limiter is essentially an if voltage amplifier designed for saturated operation. Saturated operation means that an increase in signal voltage above a certain value produces very little increase in plate current. A signal voltage which is never less than sufficient to cause saturation of the limiter, even on weak signals, is supplied to the limiter input by the preceding stages. Any change in amplitude, therefore, such as might be produced by noise voltage fluctuation, is not reproduced in the limiter output. The limiting action, of course, does not interfere with the reproduction of frequency variations. Plate-current saturation of the limiter may be obtained by the use of grid-resistor-and-capacitor bias with plate and screen voltages which are low compared with customary if-amplifier operating conditions. As a result of these design features, the limiter is able to maintain its output voltage at a constant amplitude over a wide range of input-signal voltage variations. The output of the limiter is frequency-modulated if voltage, the mean frequency of which is that of the if amplifier. This voltage is impressed on the input of the detector.

The reception of FM signals without serious distortion requires that the response of the receiver be such that satisfactory amplification of the signal is provided over the entire range of frequency deviation from the mean frequency. Since the frequency at any instant depends on the modulation at that instant, it follows that excessive attenuation toward the edges of the band, in the rf or if stages, will cause distortion. This means that, in a high-fidelity receiver, the amplifiers must be capable of amplifying, for the maximum permissible frequency deviation of 75 kilocycles, a band 150 kilocycles wide. Suitable tubes for this purpose are the 6BA6 and 6BJ6.

RECTIFICATION

The rectifying action of a diode finds an important application in supplying a receiver with dc power from an ac line. A typical arrangement for this application includes a rectifier tube, a filter, and a voltage divider. The rectifying action of the tube is explained briefly under **Diodes**, in the **ELECTRONS, ELECTRODES, AND ELECTRON TUBE SECTION**. The function of a filter is to smooth out the ripple of the tube output, as indicated in Fig. 30. The action of the filter is explained in **ELECTRON TUBE INSTALLATION SECTION** under **Filters**. The voltage divider is used to cut down the output voltage to the values required by the plates, screens, and grids of the tubes in the receiver.

A half-wave rectifier and a full-wave rectifier circuit are shown in Fig. 31. In the half-wave circuit, current flows through the rectifier tube to the filter on every other half-cycle of the ac input voltage when the plate is positive with respect to the cathode. In the full-wave circuit, current flows to the filter on every half-cycle,

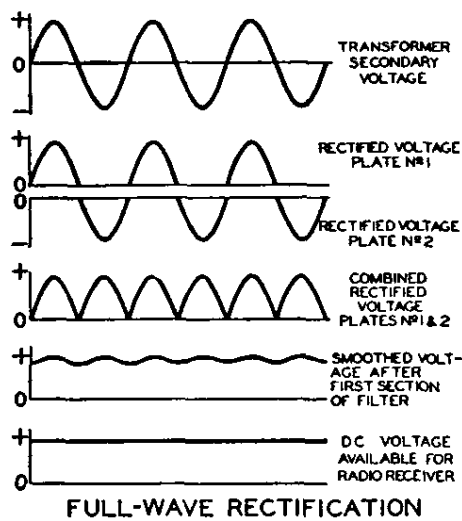

Fig. 30

through plate No. 1 on one half-cycle when plate No. 1 is positive with respect to the cathode, and through plate No. 2 on the next half-cycle when plate No. 2 is positive with respect to the cathode. Because the current flow to the filter is more uniform in the full-wave circuit than in the half-wave circuit, the output of the full-wave circuit requires less filtering. Rectifier operating information and circuits are given under each rectifier tube type and in the **CIRCUIT SECTION**, respectively.

Parallel operation of rectifier tubes furnishes an output current greater than that obtainable with the use of one tube. For example, when two full-wave rectifier tubes are connected in parallel, the plates of each tube are connected together and each tube acts as a half-wave rectifier. The allowable voltage and load conditions per tube are the same as for full-wave service but the total load-handling capability of the complete rectifier is approximately doubled. When mercury-vapor rectifier tubes are connected in parallel, a stabilizing resistor of 50 to 100 ohms should be connected in series with each plate lead in order that each tube will carry an equal share of the load. The value of the resistor to be used will depend on the amount of plate current that passes through the rectifier. Low plate current requires a high value; high plate current, a low value. When the plates of mercury-vapor rectifier tubes are connected

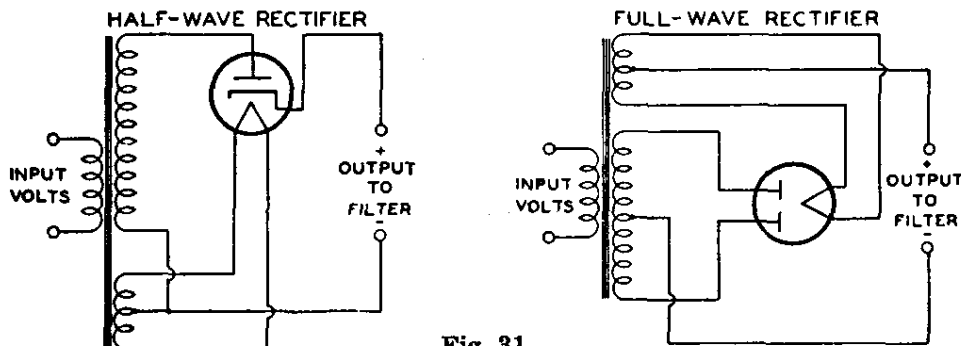

Fig. 31

in parallel, the corresponding filament leads should be similarly connected. Otherwise, the tube drops will be considerably unbalanced and larger stabilizing resistors will be required. Two or more vacuum rectifier tubes can also be connected in parallel to give correspondingly higher output current and, as a result of paralleling their internal resistances, give somewhat increased voltage output. With vacuum types, stabilizing resistors may or may not be necessary depending on the tube type and the circuit.

A voltage-doubler circuit of simple form is shown in Fig. 32. The circuit derives its name from the fact that its dc voltage output can be as high as twice the peak value of ac input. Basically, a voltage doubler is a rectifier circuit arranged so that the output voltages of two half-wave rectifiers are in series. The action of a voltage doubler is briefly as follows. On the positive half-cycle of the ac input, that is, when the upper side of the ac input line is positive with respect to the lower side, the upper diode passes current and feeds a positive charge into the upper capacitor. As positive charge accumulates on the upper plate of the capacitor, a positive voltage builds up across the capacitor. On the next half-cycle of

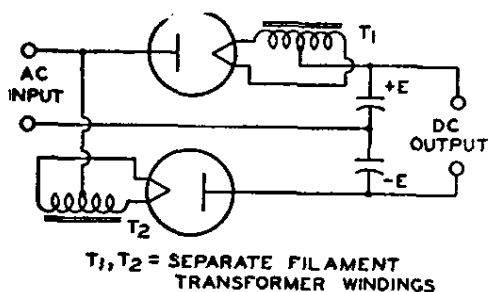

Fig. 32

the ac input, when the upper side of the line is negative with respect to the lower side, the lower diode passes current so that a negative voltage builds up across the lower capacitor. As long as no current is drawn at the output terminals from the capacitor, each capacitor can charge up to a voltage of magnitude E , the peak value of the ac input. It can be seen from the diagram that with a voltage of $+E$ on one capacitor and $-E$ on the other, the total voltage across the capacitors is $2E$. Thus the voltage doubler supplies a no-load dc output voltage twice as large as the peak ac input voltage. When current is drawn at the output terminals by the load, the output voltage drops below $2E$ by an amount that depends on the magnitude of the load current and the capacitance of the capacitors. The arrangement shown in Fig. 32 is called a full-wave voltage doubler because each rectifier passes current to the load on each half of the ac input cycle.

Two rectifier types especially designed for use as voltage doublers are the 25Z6-GT and 117Z6-GT. These tubes combine two separate diodes in one tube. As voltage doublers, the tubes are used in "transformerless" receivers. In these receivers, the heaters of all tubes in the set are connected in series with a voltage-dropping resistor across the line. The connections for the heater supply and the voltage-doubling circuit are shown in Figs. 33 and 34.

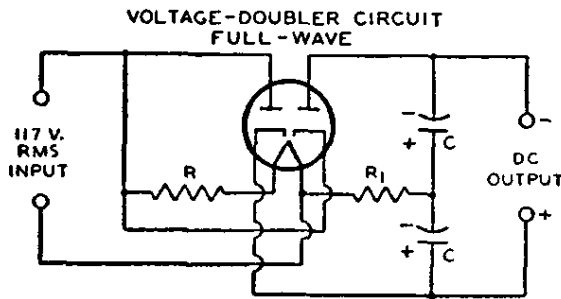

Fig. 33

R = HEATERS OF OTHER TUBES IN SERIES WITH VOLTAGE-DROPPING RESISTOR
 R_1 = PROTECTIVE RESISTOR

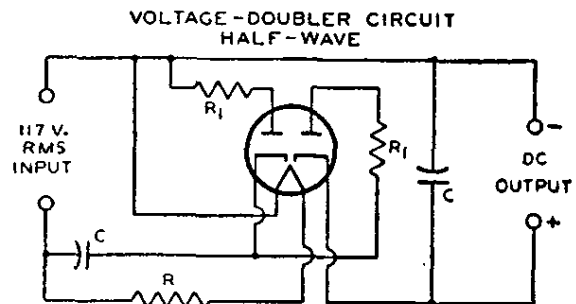

Fig. 34

With the full-wave voltage-doubler circuit in Fig. 33, it will be noted that the dc load circuit can not be connected to ground or to one side of the ac supply line. This presents certain disadvantages when the heaters of all the tubes in the set are connected in series with a resistance across the ac line. Such a circuit arrangement may cause hum because of the high ac potential between the heaters and cathodes of the tubes. The circuit in Fig. 34 overcomes this difficulty by making one side of the ac line common with the negative side of the dc load circuit. In this circuit, one half of the tube is used to charge a capacitor which, on the following half cycle, discharges in series with the line voltage through the other half of the tube. This circuit is called a half-wave voltage doubler because rectified current flows to the load only on alternate halves of the ac input cycle. The voltage regulation of this arrangement is somewhat poorer than that of the full-wave voltage doubler.

DETECTION

When speech or music is transmitted from a radio station, the station radiates a radio-frequency (rf) wave which is of either of two general types. In one type, the wave is said to be amplitude modulated when its frequency remains constant and the amplitude is varied. In the other type, the wave is said to be frequency modulated when its amplitude remains essentially constant but its frequency is varied. In either case, the varying component is modulated in accordance with the audio frequencies (af) of the speech or music being transmitted.

The function of the receiver is to reproduce the original af modulating wave

from the modulated rf wave. The receiver stage in which this function is performed is called the demodulator or detector stage.

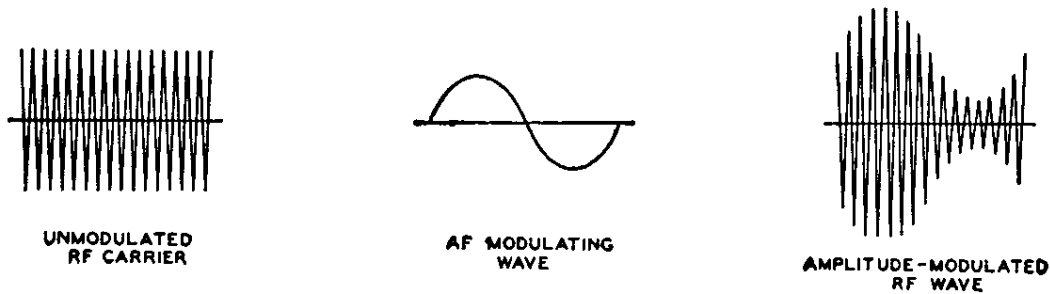

Fig. 35

The effect of **amplitude modulation** on the waveform of the rf wave is shown in Fig. 35. There are three different basic circuits used for the detection of amplitude-modulated waves: the diode detector, the grid-bias detector, and the grid-resistor detector. These circuits are alike in that they eliminate, either partially or completely, alternate half-cycles of the rf wave. With alternate half-cycles removed, the audio variations of the other half-cycles can be amplified to drive headphones or a loudspeaker.

A **diode-detector** circuit is shown in Fig. 36. The action of this circuit when a modulated rf wave is applied is illustrated by Fig. 37. The rf voltage applied to the circuit is shown in light line; the output voltage across capacitor C is shown in heavy line. Between points (a) and (b) on the first positive half-cycle of the applied rf voltage, capacitor C charges up to the peak value of the rf voltage. Then as the applied rf voltage falls away from its peak value, the capacitor holds the cathode at a potential more positive than the voltage applied to the anode. The capacitor thus temporarily cuts off current through the diode. While the diode current is cut off, the capacitor discharges from (b) to (c) through the diode load resistor R. When the rf voltage on the anode rises high enough to exceed the potential at which the capacitor holds the cathode, current flows again and

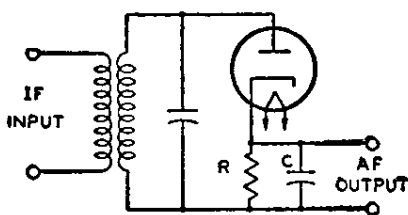

Fig. 36

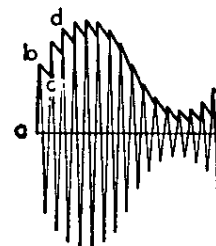

Fig. 37

the capacitor charges up to the peak value of the second positive half-cycle at (d). In this way, the voltage across the capacitor follows the peak value of the applied rf voltage and reproduces the af modulation. The curve for voltage across the capacitor, as drawn in Fig. 37, is somewhat jagged. However, this jaggedness, which represents an rf component in the voltage across the capacitor, is exaggerated in the drawing. In an actual circuit the rf component of the voltage across the capacitor is negligible. Hence, when the voltage across the capacitor is amplified, the output of the amplifier reproduces the speech or music originating at the transmitting station.

Another way to describe the action of a diode detector is to consider the circuit as a half-wave rectifier. When the rf signal on the plate swings positive, the tube conducts and the rectified current flows through the load resistance R. Because the dc output voltage of a rectifier depends on the voltage of the ac input,

the dc voltage across C varies in accordance with the amplitude of the rf carrier and thus reproduces the af signal. Capacitor C should be large enough to smooth out rf or if variations but should not be so large as to affect the audio variations. Two diodes can be connected in a circuit similar to a full-wave rectifier to give full-wave detection. However, in practice, the advantages of this connection generally do not justify the extra circuit complication.

The diode method of detection has the advantage over other methods in that it produces less distortion. The reason is that the dynamic characteristics of a diode can be made more linear than that of other detectors. A diode has the disadvantages that it does not amplify the signal, and that it draws current from the input circuit and therefore reduces the selectivity of the input circuit. However, because the diode method of detection produces less distortion and because it permits the use of simple avc circuits without the necessity for an additional voltage supply, the diode method of detection is most widely used in broadcast receivers.

A typical diode-detector circuit using a twin-diode triode tube is shown in Fig. 38. Both diodes are connected together. R_1 is the diode load resistor. A por-

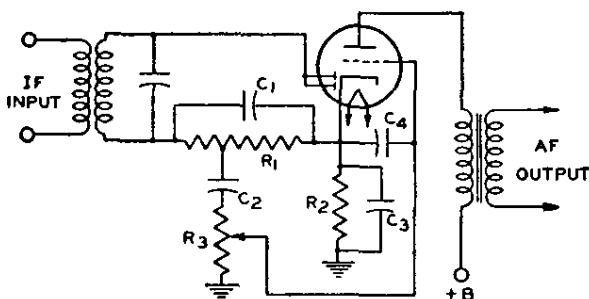

Fig. 38

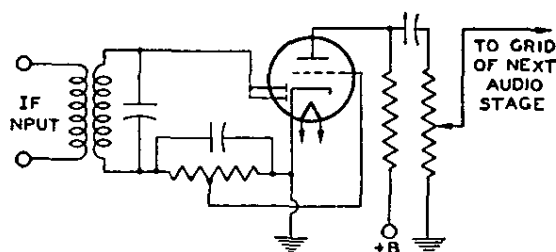

Fig. 39

tion of the af voltage developed across this resistor is applied to the triode grid through the volume control R_3 . In a typical circuit, resistor R_1 may be tapped so that five-sixths of the total af voltage across R_1 is applied to the volume control. This tapped connection reduces the af voltage output of the detector circuit slightly but it reduces audio distortion and improves the rf filtering. DC bias for the triode section is provided by the cathode-bias resistor R_2 and the audio bypass capacitor C_3 . The function of capacitor C_2 is to block the dc bias of the cathode from the grid. The function of capacitor C_4 is to bypass any rf voltage on the grid to cathode. A twin-diode pentode may also be used in this circuit. With a pentode, the af output should be resistance-coupled rather than transformer-coupled.

Another diode-detector circuit, called a diode-biased circuit, is shown in Fig. 39. In this circuit, the triode grid is connected directly to a tap on the diode load resistor. When an rf signal voltage is applied to the diode, the dc voltage at the tap supplies bias to the triode grid. When the rf signal is modulated, the af voltage at the tap is applied to the grid and is amplified by the triode. The advantage of this circuit over the self-biased arrangement shown in Fig. 38 is that the diode-biased circuit does not employ a capacitor between the grid and the diode load resistor, and consequently does not produce as much distortion of a signal having a high percentage of modulation.

However, there are restrictions on the use of the diode-biased circuit. Because the bias voltage on the triode depends on the average amplitude of the rf voltage applied to the diode, the average amplitude of the voltage applied to the diode should be constant for all values of signal strength at the antenna. Otherwise there will be different values of bias on the triode grid for different signal strengths

and the triode will produce distortion. Since there is no bias applied to the diode-biased triode when no rf voltage is applied to the diode, sufficient resistance should be included in the plate circuit of the triode to limit its zero-bias plate current to a safe value. These restrictions mean, in practice, that the receiver should have a separate-channel avc system. With such an avc system, the average amplitude of the signal voltage applied to the diode can be held within very close limits for all values of signal strength at the antenna. The tube used in a diode-biased circuit should be one which operates at a fairly large value of bias voltage. The variations in bias voltage are then a small percentage of the total bias and hence produce small distortion. Tubes taking a fairly large bias voltage are types such as the 6BF6 or 6ST7 having a medium-mu triode. Tube types having a high-mu triode or a pentode should not be used in a diode-biased circuit.

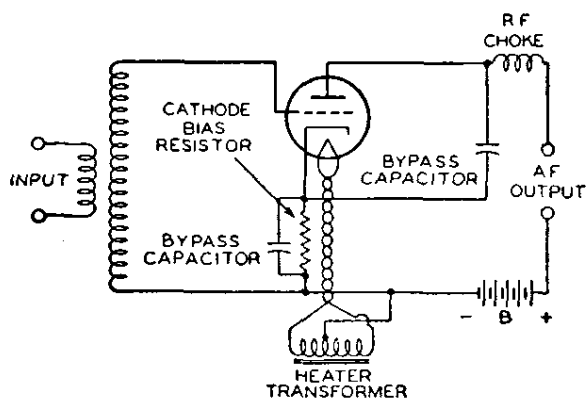

Fig. 40

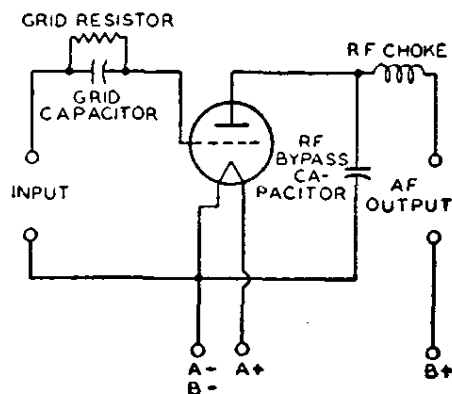

Fig. 41

A grid-bias detector circuit is shown in Fig. 40. In this circuit, the grid is biased almost to cutoff, i.e., operated so that the plate current with zero signal is practically zero. The bias voltage can be obtained from a cathode-bias resistor, a C-battery, or a bleeder tap. Because of the high negative bias, only the positive half-cycles of the rf signal are amplified by the tube. The signal is, therefore, detected in the plate circuit. The advantages of this method of detection are that it amplifies the signal, besides detecting it, and that it does not draw current from the input circuit and therefore does not lower the selectivity of the input circuit.

The grid-resistor-and-capacitor method, illustrated by Fig. 41, is somewhat more sensitive than the grid-bias method and gives its best results on weak signals. In this circuit, there is no negative dc bias voltage applied to the grid. Hence, on the positive half-cycles of the rf signal, current flows from grid to cathode. The grid and cathode thus act as a diode detector, with the grid resistor as the diode load resistor and the grid capacitor as the rf bypass capacitor. The voltage across the capacitor then reproduces the af modulation in the same manner as has been explained for the diode detector. This voltage appears between the grid and cathode and is therefore amplified in the plate circuit. The output voltage thus reproduces the original af signal.

In this detector circuit, the use of a high-resistance grid resistor increases selectivity and sensitivity. However, improved af response and stability are obtained with lower values of grid-resistor resistance. This detector circuit has the advantage that it amplifies the signal but has the disadvantage that it draws current from the input circuit and therefore lowers the selectivity of the input circuit.

The effect of frequency modulation on the waveform of the rf wave is shown in Fig. 42. In this type of transmission, the frequency of the rf wave deviates from

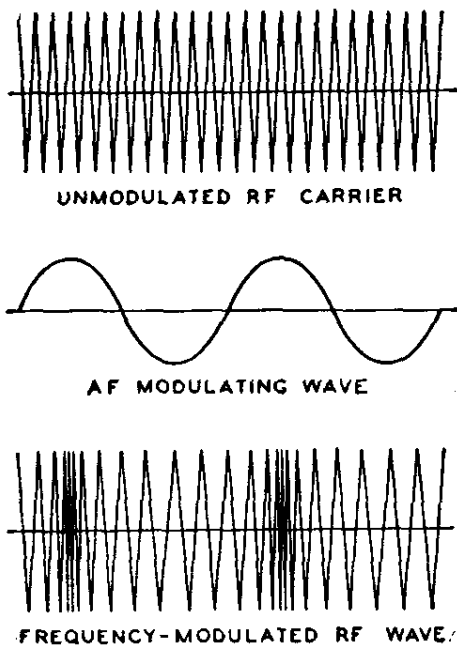

Fig. 42

a mean value, at an af rate depending on the modulation, by an amount that is determined in the transmitter and is proportional to the amplitude of the af modulation signal. For this type of modulation, a detector is required to discriminate between deviations above and below the mean frequency and to translate those deviations into a voltage whose amplitude varies at audio frequencies. Since the deviations occur at an audio frequency, the process is one of demodulation, and the degree of frequency deviation determines the amplitude of the demodulated (af) voltage.

A simple circuit for converting frequency variations to amplitude variations is a circuit which is tuned so that the mean radio frequency is on one slope of its resonance characteristic, as at A of Fig. 43. With modulation, the frequency swings between B and C, and the voltage developed across the circuit varies at the modulating rate. In order that no distortion will be introduced in this circuit, the frequency swing must be restricted to the portion of the slope which is effectively straight. Since this portion is very short, the voltage developed is low. Because of these limitations, this circuit is not commonly used but it serves to illustrate the principle.

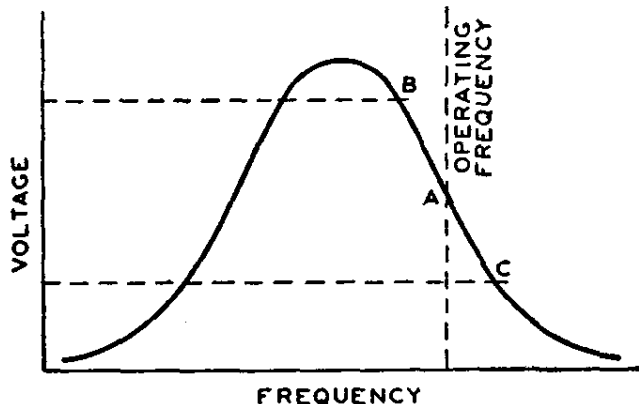

Fig. 43

The faults of the simple circuit are overcome in a push-pull arrangement, sometimes called a **discriminator circuit**, such as that shown in Fig. 44. Because of the phase relationships between the primary and each half of the secondary of the input transformer (each half of the secondary is connected in series with the primary through capacitor C_2), the rf voltages applied to the diodes become unequal as the rf signal swings from the resonant frequency in each direction. Since the

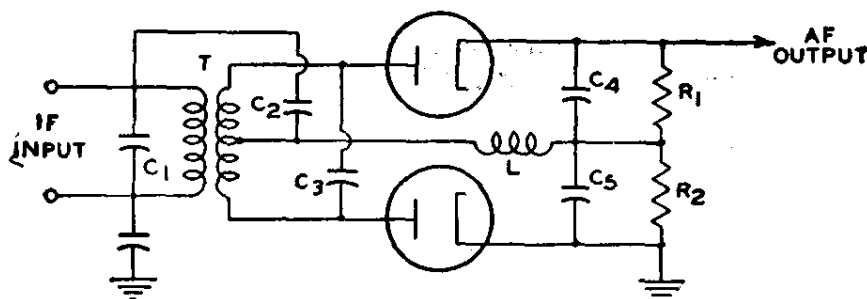

Fig. 44

swing occurs at audio frequencies (determined by the af modulation), the voltage developed across the diode load resistors, R_1 and R_2 connected in series, varies at audio frequencies. The output voltage depends on the difference in amplitude of the voltages developed across R_1 and R_2 . These voltages are equal and of opposite sign when the rf carrier is not modulated and the output is, therefore, zero. When modulation is applied, the output voltage varies as indicated in Fig. 45.

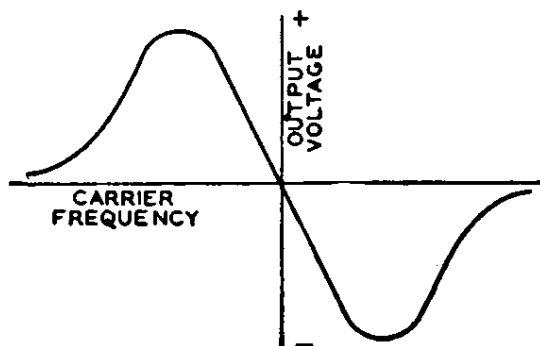

Fig. 45

Because this type of FM detector is sensitive to amplitude variations in the rf carrier, a limiter stage is frequently used to remove most of the amplitude modulation from the carrier. (See Limiters under Amplification.)

Another form of detector for frequency-modulated waves is called a **ratio detector**. This FM detector, unlike the previous one which responds to a difference in voltage, responds only to changes in the ratio of the voltage across the two diodes (Fig. 46) and is, therefore, insensitive to changes in the differences in the voltages due to amplitude modulation of the rf carrier.

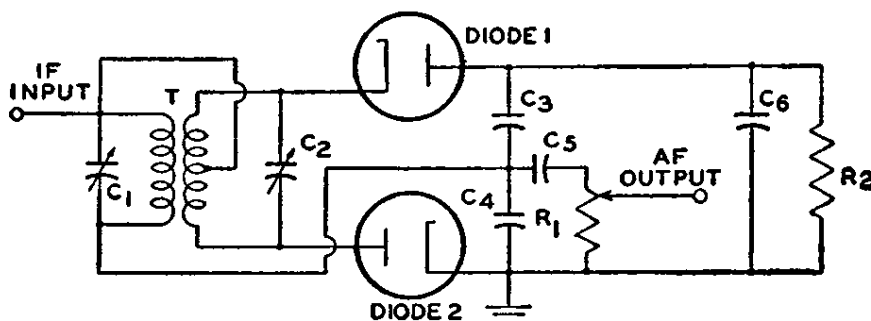

Fig. 46

The basic ratio detector is given in Fig. 46. The plate load for the final intermediate-frequency-amplifier stage is the parallel resonant circuit consisting of C_1 and the primary transformer T . The tuning and coupling of the transformer is practically the same as in the previous circuit and, therefore, the rf voltages applied to the diodes depend upon how much the rf signal swings from the resonant frequency in each direction. At this point the similarity ends.

Diode 1, R_2 , and diode 2 complete a series circuit fed by the secondary of the transformer T . The two diodes are connected in series so that they conduct on the same rf half-cycle. The rectified current through R_2 causes a negative voltage to appear at the plate of diode 1. Because C_6 is large, this negative voltage at the plate of diode 1 remains constant even at the lowest audio frequencies to be reproduced. The rectified voltage across C_3 is proportional to the voltage across diode 1, and the rectified voltage across C_4 is proportional to the voltage across diode 2. Since the voltages across the two diodes differ according to the instantaneous frequency of the carrier, the voltages across C_3 and C_4 differ proportionately, the voltage across C_3 being the larger of the two voltages at carrier frequencies below the intermediate frequency and the smaller at frequencies above the intermediate frequency. These voltages across C_3 and C_4 are additive and their sum is fixed by the constant voltage

across C_6 . Therefore, while the ratio of these voltages varies at an audio rate, their sum is always constant. The voltage across C_4 varies at an audio rate when a frequency-modulated rf carrier is applied to the ratio detector; this audio voltage is extracted and fed to the audio amplifier. For a complete circuit utilizing this type of detector, refer to the **CIRCUIT SECTION**.

AUTOMATIC VOLUME CONTROL

The chief purposes of automatic volume control in a receiver are to prevent fluctuations in loudspeaker volume when the signal at the antenna is fading in and out, and to prevent an unpleasant blast of loud volume when the set is tuned from

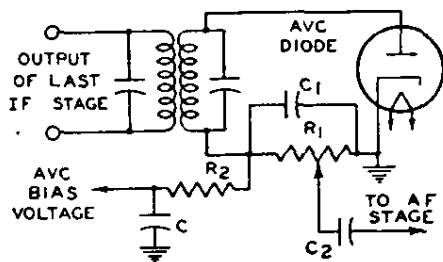

Fig. 47

a weak signal, for which the volume control has been turned up high, to a strong signal. To accomplish these purposes, an automatic volume control circuit regulates the receiver's rf and if gain so that this gain is less for a strong signal than for a weak signal. In this way, when the signal strength at the antenna changes, the avc circuit reduces the resultant change in the voltage output of the last if stage and consequently reduces the change in the speaker's output volume.

The avc circuit reduces the rf and if gain for a strong signal usually by increasing the negative bias of the rf, if, and frequency-mixer stages when the signal increases. A simple avc circuit is shown in Fig. 47. On each positive half-cycle of the signal voltage, when the diode plate is positive with respect to the cathode, the diode passes current. Because of the flow of diode current through R_1 , there is a voltage drop across R_1 which makes the left end of R_1 negative with respect to ground. This voltage drop across R_1 is applied, through the filter R_2 and C , as negative bias on the grids of the preceding stages. Then, when the signal strength at the antenna increases, the signal applied to the avc diode increases, the voltage drop across R_1 increases, the negative bias voltage applied to the rf and if stages increases, and the gain of the rf and if stages is decreased. Thus the increase in signal strength at the antenna does not produce as much increase in the output of the last if stage as it would produce without avc. When the signal strength at the antenna decreases from a previous steady value, the avc circuit acts, of course, in the reverse direction, applying less negative bias, permitting the rf and if gain to increase, and thus reducing the decrease in the signal output of the last if stage. In this way, when the signal strength at the antenna changes, the avc circuit acts to prevent change in the output of the last if stage, and thus acts to prevent change in loudspeaker volume.

The filter, C and R_2 , prevents the avc voltage from varying at audio frequency. The filter is necessary because the voltage drop across R_1 varies with the modulation of the carrier being received. If avc voltage were taken directly from R_1 without filtering, the audio variations in avc voltage would vary the receiver's gain so as to smooth out the modulation of the carrier. To avoid this effect, the avc voltage is taken from the capacitor C . Because of the resistance R_2 in series with C , the capacitor C can charge and discharge at only a comparatively slow rate. The avc voltage therefore cannot vary at frequencies as high as the audio range but can vary at frequencies high enough to compensate for most fading. Thus the filter permits the avc circuit to smooth out variations

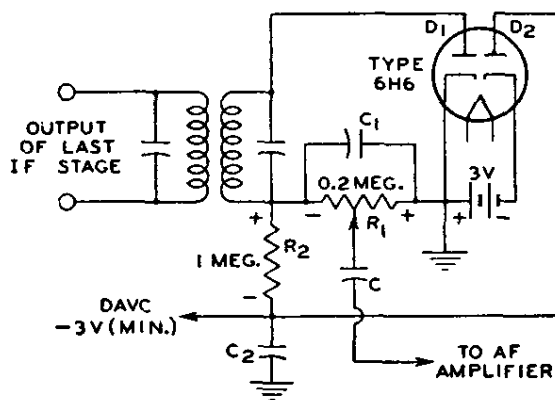

Fig. 48

in signal due to fading, but prevents the circuit from smoothing out audio modulation.

It will be seen that an avc circuit and a diode-detector circuit are much alike. It is therefore convenient in a receiver to combine the detector and the avc diode in a single stage. Examples of how these functions are combined in receivers are shown in CIRCUIT SECTION.

In the circuit shown in Fig. 47, a certain amount of avc negative bias is applied to the preceding stages on a weak signal. Since it may be desirable to maintain the receiver's rf and if gain at the maximum possible value for a weak signal, avc circuits are designed in some cases to apply no avc bias until the signal strength exceeds a certain value. These avc circuits are known as delayed avc, or, dave circuits. A dave circuit is shown in Fig. 48. In this circuit, the diode section D_1 of the 6H6 acts as detector and avc diode. R_1 is the diode load resistor and R_2 and C_2 are the avc filter. Because the cathode of diode D_2 is returned through a fixed supply of -3 volts to the cathode of D_1 , a dc current flows through R_1 and R_2 in series with D_2 . The voltage drop caused by this current places the avc lead at approximately -3 volts (less the negligible drop through D_2). When the average amplitude of the rectified signal developed across R_1 does not exceed 3 volts, the avc lead remains at -3 volts. Hence, for signals not strong enough to develop 3 volts across R_1 , the bias applied to the controlled tubes stays constant at a value giving high sensitivity. However, when the average amplitude of rectified signal voltage across R_1 exceeds 3 volts, the plate of diode D_2 becomes more negative than the cathode of D_2 and current flow in diode D_2 ceases. The potential of the avc lead is then controlled by the voltage developed across R_1 . Therefore, with further increase in signal strength, the avc circuit applies an increasing avc bias voltage to the controlled stages. In this way, the circuit regulates the receiver's gain for strong signals, but permits the gain to stay constant at a maximum value for weak signals.

It can be seen in Fig. 48 that a portion of the -3 volts delay voltage is applied to the plate of the detector diode D_1 , this portion being approximately equal to $R_1/(R_1 + R_2)$ times -3 volts. Hence, with the circuit constants as shown, the detector plate is made negative with respect to its cathode by approximately one-half volt. However, this voltage does not interfere with detection because it is not large enough to prevent current flow in the tube.

TUNING INDICATION WITH ELECTRON-RAY TUBES

Electron-ray tubes are designed to indicate visually by means of a fluorescent target the effects of a change in controlling voltage. One application of them is as tuning indicators in radio receivers. Types such as the 6U5/6G5 and the 6AB5/6N5

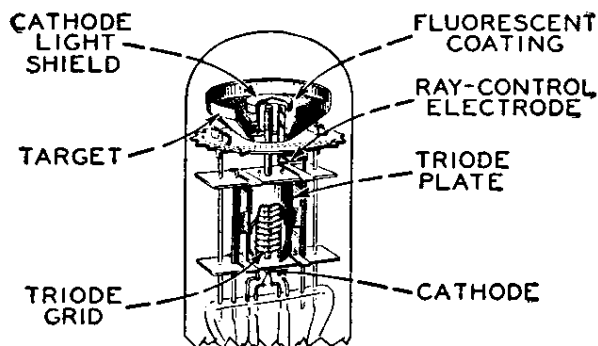

Fig. 49

contain two main parts: (1) a triode which operates as a dc amplifier and (2) an electron-ray indicator which is located in the bulb as shown in Fig. 49. The target is operated at a positive voltage and therefore attracts electrons from the cathode. When the electrons strike the target they produce a glow on the fluorescent coating of the target. Under these conditions, the target appears as a ring of light.

A ray-control electrode is mounted between the cathode and target. When the potential of this electrode is less positive than the target, electrons flowing to the target are repelled by the electrostatic field of the electrode, and do not reach that portion of the target behind the electrode. Because the target does not glow where it is shielded from electrons, the

control electrode casts a shadow on the glowing target. The extent of this shadow varies from approximately 100° of the target when the control electrode is much more negative than the target to 0° when the control electrode is at approximately the same potential as the target.

In the application of the electron-ray tube, the potential of the control electrode is determined by the voltage on the grid of the triode section, as can be seen in Fig. 50. The flow of the triode plate current through resistor R produces a voltage drop which determines the potential of the control electrode. When the voltage of the triode grid changes in the positive direction, plate current increases, the potential of the control electrode goes down because of the increased drop across R , and the shadow angle widens. When the potential of the triode grid changes in the negative direction, the shadow angle narrows.

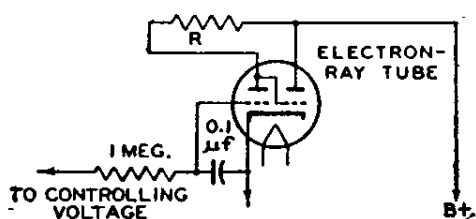

Fig. 50

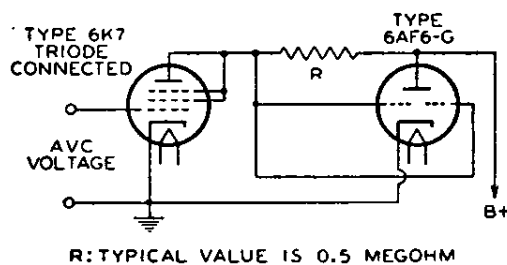

Fig. 51

Another type of indicator tube is the 6AF6-G. This tube contains only an indicator unit but employs two ray-control electrodes mounted on opposite sides of the cathode and connected to individual base pins. It employs an external dc amplifier. See Fig. 51. Thus, two symmetrically opposite shadow angles may be obtained by connecting the two ray-control electrodes together; or, two unlike patterns may be obtained by individual connection of each ray-control electrode to its respective amplifier.

In radio receivers, avc voltage is applied to the grid of the dc amplifier. Since avc voltage is at maximum when the set is tuned to give maximum response to a station, the shadow angle is at minimum when the receiver is tuned to resonance with the desired station.

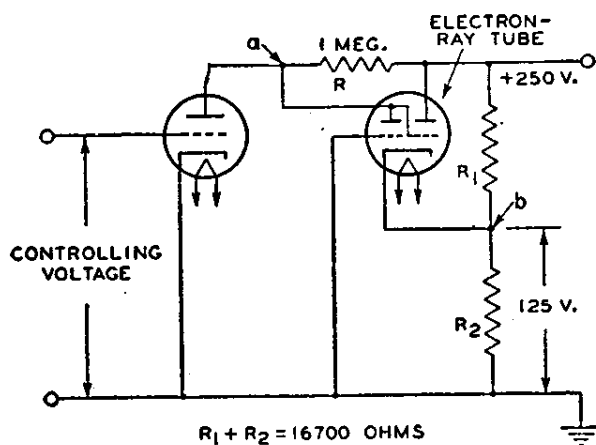

Fig. 52

The choice between electron-ray tubes depends on the avc characteristic of the receiver. The 6E5 contains a sharp-cutoff triode which closes the shadow angle on a comparatively low value of avc voltage. The 6AB5/6N5 and 6U5/6G5 each have a remote-cutoff triode which closes the shadow on a larger value of avc voltage than the 6E5. The 6AF6-G may be used in conjunction with dc amplifier tubes having either remote- or sharp-cutoff characteristics. Examples showing how electron-ray tubes are incorporated in receiver circuits are given in CIRCUIT SECTION.

The sensitivity indication of electron-ray tubes can be increased by using a separate dc amplifier to control the action of the ray-control electrode in the tuning indicator tube. This arrangement increases the maximum shadow angle from the usual 100° to approximately 180° . A circuit for obtaining wide-angle tuning is shown in Fig. 52.

OSCILLATION

As an oscillator, an electron tube can be employed to generate a continuously alternating voltage. In present-day radio broadcast receivers, this application is limited practically to superheterodyne receivers for supplying the heterodyning frequency. Several circuits (represented in Figs. 53 and 54) may be utilized, but they all depend on feeding more energy from the plate circuit to the grid circuit than is required to equal the power loss in the grid circuit. Feedback may be

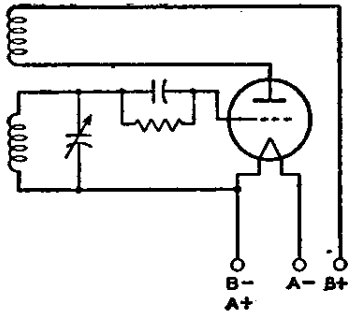

Fig. 53

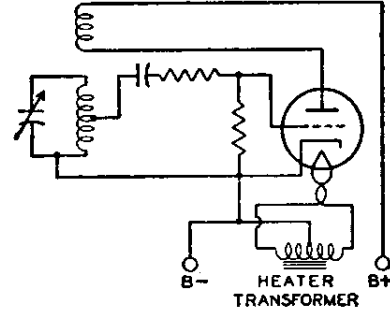

Fig. 54

produced by electrostatic or electromagnetic coupling between the grid and plate circuits. When sufficient energy is fed back to more than compensate for the loss in the grid circuit, the tube will oscillate. The action consists of regular surges of power between the plate and the grid circuit at a frequency dependent on the circuit constants of inductance and capacitance. By proper choice of these values, the frequency may be adjusted over a very wide range.

The **relaxation oscillator** is an oscillator with a non-sinusoidal output. It differs from the preceding type in that the oscillations are obtained by abruptly releasing energy previously stored in the electric field of a capacitor. A **multivibrator** is a special type of relaxation oscillator used in television receivers and other electronic applications. A multivibrator may be considered as a two-stage resistance-coupled amplifier in which the output of each tube is coupled into the input of the other tube in order to sustain oscillations.

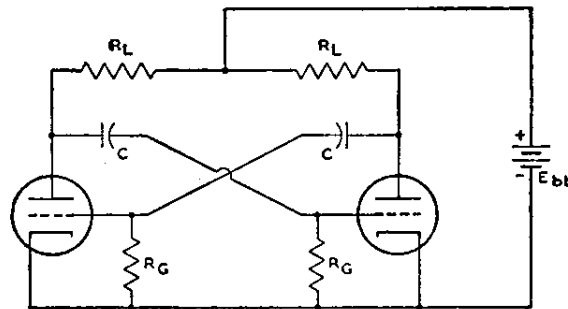

Fig. 55

Fig. 55 is a basic multivibrator circuit of the free-running type. In this circuit, oscillations are maintained by the alternate shifting of conduction from one tube to the other. The cycle starts with one tube usually at zero bias and the other at cutoff or beyond. Each tube introduces a 180° phase shift so that the energy fed back has the phase relation necessary to sustain oscillation. The frequency of oscillation is determined primarily by the constants of the resistance-capacitance coupling circuits.

FREQUENCY CONVERSION

Frequency conversion is used in superheterodyne receivers to change the frequency of the rf signal to an intermediate frequency. To perform this change in frequency, a frequency-converting device consisting of an oscillator and a frequency mixer is employed. In such a device, shown diagrammatically in Fig. 56,

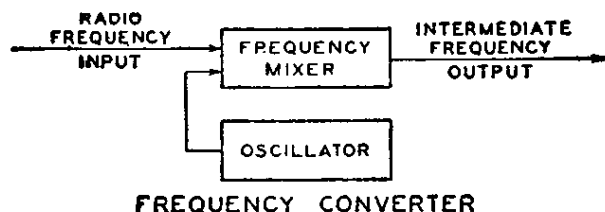

Fig. 56

numerous sum and difference frequencies. The output circuit of the mixer stage is provided with a tuned circuit which is adjusted to select only one beat frequency, i.e., the frequency equal to the difference between the signal frequency and the oscillator frequency. The selected output frequency is known as the intermediate frequency, or if. The output frequency of the mixer tube is kept constant for all values of signal frequency by tuning the oscillator to the proper frequency.

Important advantages gained in a receiver by the conversion of signal frequency to a fixed intermediate frequency are high selectivity with few tuning stages and a high, as well as stable, overall gain for the receiver.

Several methods of frequency conversion for superheterodyne receivers are of interest. These methods are alike in that they employ a frequency-mixer tube in which plate current is varied at a combination frequency of the signal frequency and the oscillator frequency. These variations in plate current produce across the tuned plate load a voltage of the desired intermediate frequency. The methods differ in the types of tubes employed and in the means of supplying input voltages to the mixer tube.

A method widely used before the availability of tubes especially designed for frequency-conversion service and currently used in many FM, television, and standard broadcast receivers, employs as mixer tube either a triode, a tetrode, or a pentode, in which oscillator voltage and signal voltage are applied to the same grid. In this method, coupling between the oscillator and mixer circuits is obtained by means of inductance or capacitance.

A second method employs a tube having an oscillator and frequency mixer combined in the same envelope. In one form of such a tube, coupling between the two units is obtained by means of the electron stream within the tube. One arrangement of the electrodes for this type is shown in Fig. 57. Since five grids are used, the tube is called a pentagrid converter. Grids No. 1, No. 2, and the cathode are connected to an external circuit to act as a triode oscillator. Grid No. 1 is the grid of the oscillator and grid No. 2 is the anode. These and the cathode can be considered as a composite cathode which supplies to the rest of the tube an electron stream that varies at the oscillator frequency. This varying electron stream is further controlled by the rf signal voltage on grid No. 4. Thus, the variations in plate current are due to the combination of the oscillator and the signal frequencies. The purpose of grids No. 3 and No. 5, which are connected together within the tube, is to accelerate the electron stream and to shield grid No. 4 electrostatically from the other electrodes. The 6A8 is an example of a pentagrid-converter type.

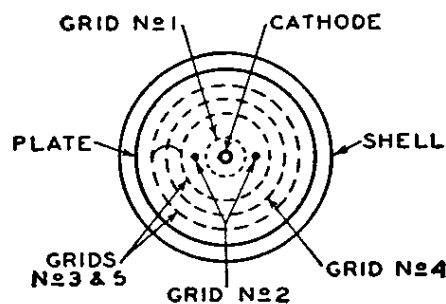

Fig. 57

Pentagrid-converter tubes of this design are good frequency-converting devices at medium frequencies but their performance is better at the lower frequencies than at the high ones. This is because the output of the oscillator drops off as the frequency is

raised and because certain undesirable effects produced by interaction between oscillator and signal sections of the tube increase with frequency. To minimize these effects, several of the pentagrid-converter tubes are designed so that no electrode functions alone as the oscillator anode. In these tubes, grid No. 1 functions as the oscillator grid, and grid No. 2 is connected within the tube to the screen (grid No. 4). The combined two grids Nos. 2 and 4 shield the signal grid (grid No. 3) and act as the composite anode of the oscillator triode. Grid No. 5 acts as the suppressor. Converter tubes of this type are designed so that the space charge around the cathode is unaffected by electrons from the signal grid. Furthermore, the electrostatic field of the signal grid also has little effect on the space charge. The result is that rf voltage on the signal grid produces little effect on the cathode current. There is, therefore, little detuning of the oscillator by avc bias because changes in avc bias produce little change in oscillator transconductance or in the input capacitance of grid No. 1. Examples of the pentagrid converters discussed in this paragraph are the single-ended types 1R5 and 6BE6. A schematic diagram illustrating the use of the 6BE6 with self-excitation is given in Fig. 58; the 6BE6 may also be used with separate excitation. A complete circuit is shown in the CIRCUIT SECTION.

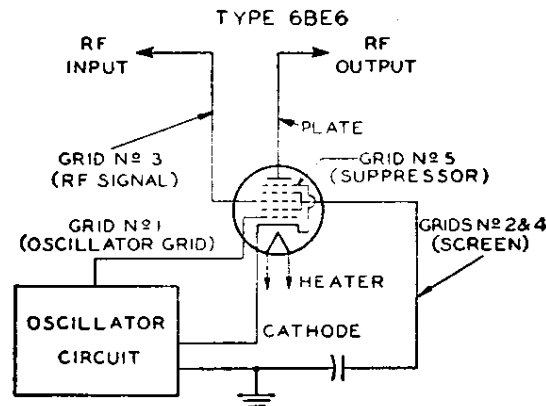

Fig. 58

Another method of frequency conversion utilizes a separate oscillator having its grid connected to the No. 1 grid of a mixer hexode. A tube utilizing this construction is the 6K8 and a top view of its electrode arrangement is shown in Fig. 59. The cathode, triode grid No. 1, and triode plate form the oscillator unit of the tube.

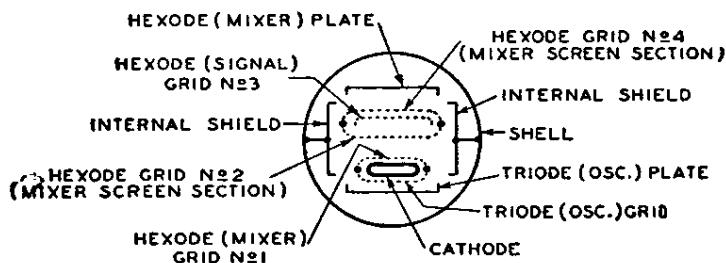

Fig. 59

The cathode, hexode mixer grid (grid No. 1), hexode double-screen (grids Nos. 2 and 4), hexode mixer grid (grid No. 3), and hexode plate constitute the mixer unit. The internal shields are connected to the shell of the tube and act as a suppressor for the hexode unit. The action of the 6K8 in converting a radio-

frequency signal to an intermediate frequency depends on (1) the generation of a local frequency by the triode unit, (2) the transferring of this frequency to the hexode grid No. 1, and (3) the mixing in the hexode unit of this frequency with that of the rf signal applied to the hexode grid No. 3. The 6K8 is not critical to changes in oscillator-plate voltage or signal-grid bias and, therefore, finds important use in all-wave receivers to minimize frequency-shift effects at the higher frequencies.

A further method of frequency conversion employs a tube called a pentagrid mixer. This type has two independent control grids and is used with a separate

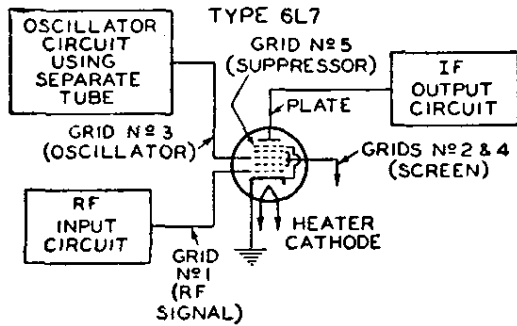

Fig. 60

oscillator tube. RF signal voltage is applied to one of the control grids and oscillator voltage is applied to the other. It follows, therefore, that the variations in plate current are due to the combination of the oscillator and signal frequencies. The arrangement of electrodes in a pentagrid-mixer tube is shown in Fig. 60. The tube contains a heater cathode, five grids, and a plate. Grids Nos. 1 and 3 are control grids. The rf signal voltage is applied to grid No. 1. This grid has a remote-cutoff characteristic and is suited for control

by avc bias voltage. The oscillator voltage is applied to grid No. 3. This grid has a sharp-cutoff characteristic and produces a comparatively large effect on plate current for a small amount of oscillator voltage. Grids Nos. 2 and 4 are connected together within the tube. They accelerate the electron stream and shield grid No. 3 electrostatically from the other electrodes. Grid No. 5, connected within the tube to the cathode, functions similarly to the suppressor in a pentode. The 6L7 and 6L7-G are pentagrid-mixer tubes.

AUTOMATIC FREQUENCY CONTROL

An automatic frequency control (afc) circuit provides a means of correcting automatically the intermediate frequency of a superheterodyne receiver if, for any reason, it drifts from the frequency to which the if stages are tuned. This correction is made by adjusting the frequency of the oscillator. Such a circuit will automatically compensate for slight changes in rf carrier or oscillator frequency as well as for inaccurate manual or push-button tuning.

An afc system requires two sections: a frequency detector and a variable reactance. The detector section may be essentially the same as the FM detector illustrated in Fig. 44 and discussed under **Detection**. In the afc system, however, the output is a dc control voltage, the magnitude of which is proportional to the amount of frequency shift. This dc control voltage is used to control the grid bias of an electron tube which comprises the variable reactance section (Fig. 61). The

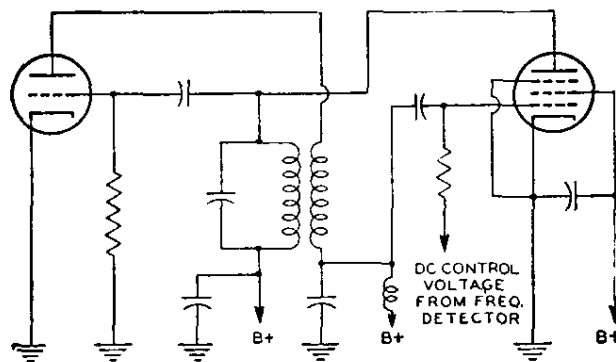

Fig. 61

plate current of the reactance tube is shunted across the oscillator tank circuit. Because the plate current and plate voltage of the reactance tube are almost 90° out of phase, the control tube affects the tank circuit in the same manner as a reactance. The grid bias of the tube determines the magnitude of the effective reactance and, consequently, a control of this grid bias can be used to control the oscillator frequency.

Electron Tube Installation

The installation of electron tubes requires care if high-quality performance is to be obtained from the associated circuits. Installation suggestions and precautions which are generally common to all types of tubes are covered in this section. Careful observance of these suggestions will do much to help the experimenter and electronic technician obtain the full performance capabilities of radio tubes and circuits. Additional pertinent information is given under each tube type and in the **CIRCUIT SECTION**.

FILAMENT AND HEATER POWER SUPPLY

The design of electron tubes allows for some variation in the voltage and current supplied to the filament or heater, but most satisfactory results are obtained from operation at the rated values. When the voltage is low, the temperature of the cathode is below normal, with the result that electron emission is limited. This may cause unsatisfactory operation and reduced tube life. On the other hand, high cathode voltage causes rapid evaporation of cathode material and shortens tube life. To insure proper tube operation, the filament or heater voltage should be checked at the socket terminals by means of an accurate voltmeter while the receiver is in operation. In the case of series operation of heaters or filaments, correct adjustment can be checked by means of an ammeter in the heater or filament circuit.

The filament or heater voltage supply may be a direct-current source (a battery or a dc power line) or an alternating-current power line, depending on the type of service and type of tube. Frequently, a resistor (either variable or fixed) is used with a dc supply to permit compensation for battery voltage variations or to adjust the tube voltage at the socket terminals to the correct value. Ordinarily, a step-down transformer is used with an ac supply to provide the proper filament or heater voltage. Receivers intended for operation on both dc and ac power lines have the heaters connected in series with a suitable resistor and supplied directly from the power line.

DC filament or heater operation should be considered on the basis of the source of power. In the case of the battery supply for the 1.4-volt filament tubes, it is unnecessary to use a voltage-dropping resistor in series with the filament and a single dry-cell; the filaments of these tubes are designed to operate satisfactorily over the range of voltage variations that normally occur during the life of a dry-cell. Likewise, no series resistor is required when the 2-volt filament type tubes are operated from a single storage cell or when the 6.3-volt series are operated from a 6-volt storage battery. In the case of dry-battery supply for 2-volt filament tubes, a variable resistor in series with the filament and the battery is required to compensate for battery variations. Turning the set on and off by means of the rheostat is advised to prevent over-voltage conditions after an off-period, for the voltage of dry-cells rises during off-periods. In the case of storage-battery supply, air-cell-battery supply, or dc power supply, a non-adjustable resistor of suitable value may be used. It is well to check initial operating conditions, and thus the resistor value, by means of a voltmeter or ammeter.

The filament or heater resistor required when filaments and/or heaters are operated in parallel can be determined easily by a simple formula derived from Ohm's law.

$$\text{Required resistance (ohms)} = \frac{\text{supply volts} - \text{rated volts of tube type}}{\text{total rated filament current (amperes)}}$$

Thus, if a receiver using three 32's, two 30's, and two 31's is to be operated from dry batteries, the series resistor is equal to 3 volts (the voltage from two dry-cells in series) minus 2 volts (voltage rating for these tubes) divided by 0.56 ampere

(the sum of 5×0.060 ampere + 2×0.130 ampere), i.e., approximately 1.8 ohms. Since this resistor should be variable to allow adjustment for battery depreciation, it is advisable to obtain the next larger commercial size, although any value between 2 and 3 ohms will be quite satisfactory. Where much power is dissipated in the resistor, the wattage rating should be sufficiently large to prevent overheating. The power dissipation in watts is equal to the voltage drop in the resistor multiplied by the total filament current in amperes. Thus, for the example above $1 \times 0.56 = 0.56$ watt. In this case, the value is so small that any commercial rheostat with suitable resistance will be adequate.

For the case where the heaters and/or filaments of several tubes are operated in series, the resistor value is calculated by the following formula, also derived from Ohm's law.

$$\text{Required resistance (ohms)} = \frac{\text{supply volts} - \text{total rated volts of tubes}}{\text{rated amperes of tubes}}$$

Thus, if a receiver having one 6SA7, one 6SK7, one 6SF7, one 25L6-GT, and one 25Z6-GT is to be operated from a 117-volt power line, the series resistor is equal to 117 volts (the supply voltage) minus 68.9 volts (the sum of 3×6.3 volts + 2×25 volts) divided by 0.3 ampere (current rating of these tubes), i.e., approximately 160 ohms. The wattage dissipation in the resistor will be 117 volts minus 68.9 volts times 0.3 ampere, or approximately 14.4 watts. A resistor having a wattage rating in excess of this value should be chosen.

It will be noted in the example for series operation that all tubes have the same current rating. If it is desired to connect in series tubes having different heater- or filament-current ratings, each tube of the lower rating should have a shunt resistor placed across its heater or filament terminals to pass the excess current. The value of this shunt resistor can be calculated from the following formula, where tube A is the tube in the series connection having the highest heater-current rating and tube B is any tube having a heater-current rating lower than tube A.

$$\text{Heater shunt resistance (ohms), tube B} = \frac{\text{heater volts, tube B}}{\text{rated heater amperes, tube A} - \text{rated heater amperes, tube B}}$$

For example, if a 6N7 having a 6.3-volt, 0.8-ampere heater is to be operated in a series-heater circuit employing several 6.3-volt tubes having heater ratings of 0.3 ampere, the required shunt resistance for each of the latter types would be

$$\text{Heater shunt resistance} = \frac{6.3}{0.8 - 0.3}, \text{ or } 12.6 \text{ ohms.}$$

The value of a series voltage-dropping resistor for a sequence of tubes having one or more shunt resistors should be calculated on the basis of the tube having the highest heater-current rating.

When the series-heater connection is used in ac/dc receivers, it is usually advisable to arrange the heaters in the circuit so that the tubes most sensitive to hum disturbances are at or near the ground potential of the circuit. This arrangement reduces the amount of ac voltage between the heaters and cathodes of these tubes and minimizes the hum output of the receiver. The order of heater connection, by tube function, from chassis to the rectifier-cathode side of the ac line is shown in Fig. 62.

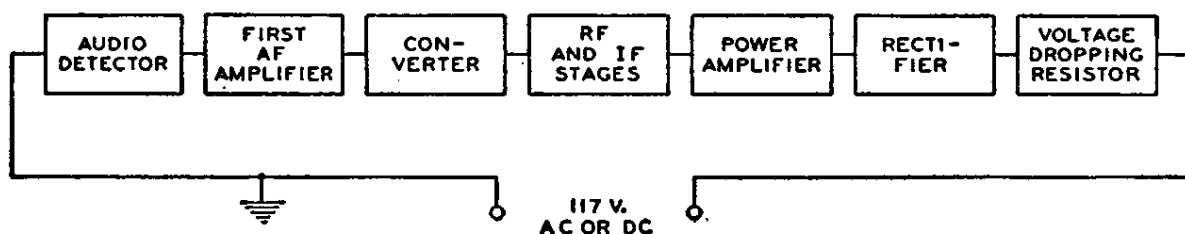

Fig. 62

AC filament or heater operation should be considered on the basis of either a parallel or a series arrangement of filaments and/or heaters. In the case of the parallel arrangement, a step-down transformer is employed. Precautions should be taken to see that the line voltage is the same as that for which the primary of the transformer is designed. The line voltage may be determined by measurement with an ac voltmeter (0-150 volts).

If the line voltage measures in excess of that for which the transformer is designed, a resistor should be placed in series with the primary to reduce the line voltage to the rated value of the transformer primary. Unless this is done, the excess input voltage will cause proportionally excessive voltage to be applied to the tubes. Any electron tube may be damaged or made inoperative by excessive operating voltages.

If the line voltage is consistently below that for which the primary of the transformer is designed, it may be necessary to install a booster transformer between the ac outlet and the transformer primary. Before such a transformer is installed, the ac line fluctuations should be very carefully noted. Some radio sets are equipped with a line-voltage switch which permits adjustment of the power transformer primary to the line voltage. When this switch is properly adjusted, the series-resistor or booster-transformer method of controlling line voltage is seldom required.

In the case of the series arrangements of filaments and/or heaters, a voltage-dropping resistance in series with the heaters and the supply line is usually required. This resistance should be of such value that, for normal line voltage, tubes will operate at their rated heater or filament current. The method for calculating the resistor value is given above.

When the filaments of battery-type tubes are connected in series, the total filament current is the sum of the current due to the filament supply and the plate and screen (cathode) currents returning to B (-) through the tube filaments. Consequently, in a series filament string it is necessary to add shunt resistors across each filament section to bypass this cathode current in order to maintain the filament voltage at its rated value.

HEATER-TO-CATHODE CONNECTION

The cathodes of heater-type tubes, when operated from ac, should be connected to the mid-tap on the heater supply winding, to the mid-tap of a 50-ohm (approximate) resistor shunted across the winding, or to one end of the heater supply winding depending on circuit requirements. If none of these methods is used, it is important to keep the heater-cathode voltage within the ratings given in the TUBE TYPES SECTION.

Hum from ac-operated heater tubes used in high-gain audio amplifiers may frequently be reduced to a negligible value by employing a 15- to 40-volt bias between the heater and cathode elements of the tubes. The bias should be connected so that the tube cathode is negative with respect to its heater. Such bias can be obtained from either B batteries or a well-filtered rectifier. If the regular plate-supply rectifier of the amplifier is employed as the bias voltage source, it is good practice to add an additional filter stage in the bias voltage circuit to insure a hum-free bias source.

If a large resistor is used between heater and cathode, it should be bypassed by a suitable filter network or objectionable hum may develop. The hum is due to the fact that even a minute pulsating leakage current flowing between the heater and cathode will develop a small voltage across any resistance in the circuit. This hum voltage is amplified by succeeding stages. When a series-heater arrangement is used, the cathode circuits should be connected either directly or through biasing resistors to the negative side of the dc plate supply, which is furnished either by the dc power line or by the ac power line through a rectifier.

PLATE VOLTAGE SUPPLY

The plate voltage for electron tubes is obtained from batteries, rectifiers, direct-current power lines, and small local generators. Auto radios have brought about the commercial development of a number of devices for obtaining a high-voltage dc supply either from the car storage-battery or from a generator driven by the car engine.

The maximum plate-voltage value for any tube type should not be exceeded if most satisfactory performance is to be obtained. Plate voltage should not be applied to a tube unless the corresponding recommended voltage is also supplied to the grid.

It is recommended that the primary circuit of the power transformer be fused to protect the rectifier tube(s), the power transformer, filter capacitor, and chokes in case a rectifier tube fails.

GRID VOLTAGE SUPPLY

The recommended grid voltages for different operating conditions have been carefully determined to give the most satisfactory performance. Grid voltage may be obtained from a separate C-battery, a tap on the voltage divider of the high-voltage dc supply, or from the voltage drop across a resistor in the cathode circuit. This last is called the "cathode-bias" or "self-bias" method. In any case, the object is to make the grid negative with respect to the cathode by the specified voltage. When a C-battery is used, the negative terminal is connected to the grid return and the positive terminal is connected to the negative filament socket terminal, or to the cathode terminal if the tube is of the heater-cathode type. If the filament is supplied with alternating current, this connection is usually made to the center-tap of a low resistance (20-50 ohms) shunted across the filament terminals. This method reduces hum disturbances caused by the ac supply. If bias voltages are obtained from the voltage divider of a high-voltage dc supply, the grid return is connected to a more negative tap than the cathode.

The **cathode-biasing** method utilizes the voltage drop produced by the cathode current flowing through a resistor connected between the cathode and the negative terminal of the B-supply. See Fig. 63. The cathode current is, of course, equal to

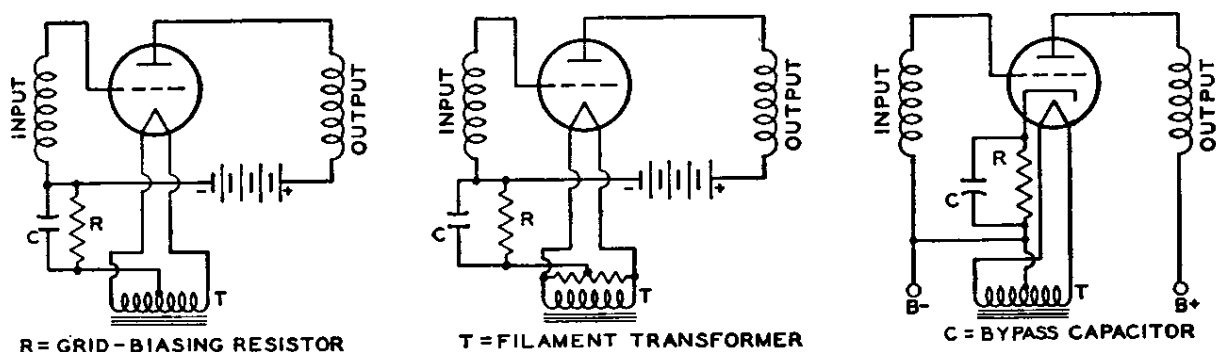

Fig. 63

the plate current in the case of a triode, or to the sum of the plate and screen currents in the case of a tetrode, pentode, or beam power tube. Since the voltage drop along the resistance is increasingly negative with respect to the cathode, the required negative grid-bias voltage can be obtained by connecting the grid return to the negative end of the resistance.

The value of the resistance for cathode-biasing a single tube can be determined from the following formula:

$$\text{Resistance (ohms)} = \frac{\text{desired grid-bias voltage} \times 1000}{\text{rated cathode current in milliamperes}}$$

Thus, the resistance required to produce 9 volts bias for a triode which operates at 3 milliamperes plate current is $9 \times 1000/3 = 3000$ ohms. If the cathode current of more than one tube passes through the resistor, or if the tube or tubes employ more than three electrodes, the total current determines the size of the resistor.

Bypassing of the cathode-bias resistor depends on circuit-design requirements. In rf circuits the cathode resistor should be bypassed. In af circuits the use of an unbypassed resistor will reduce distortion by introducing degeneration into the circuit. However, the use of an unbypassed resistor decreases power sensitivity. When bypassing is used, it is important that the bypass capacitor be sufficiently large to have negligible reactance at the lowest frequency to be amplified. In the case of power-output tubes of high transconductance such as the beam power tubes, it may be necessary to shunt the bias resistor with a small mica capacitor (approximately $0.001 \mu\text{f}$) in order to prevent oscillations. The usual af bypass may or may not be used, depending on whether or not degeneration is desired. In tubes having high values of transconductance, such as the 6BA6, 12AW6, and 6AC7, input capacitance and input conductance change appreciably with plate current. When such a tube having a separate suppressor connection is used as an rf amplifier, these changes may be minimized by leaving a portion of the cathode-bias resistor unbypassed. In order to minimize feedback when this method is used, the external grid-plate (wiring) capacitances should be kept to a minimum, the screen should be bypassed to ac ground, and the suppressor should be connected to ac ground. The use of a cathode resistor to obtain bias voltage is not recommended for audio amplifiers in which there is appreciable shift of electrode currents with the application of a signal. In such amplifiers, a separate fixed supply is recommended.

Grid-bias variation for the rf and if amplifier stages is a convenient and frequently used method for controlling receiver volume. The variable voltage supplied to the grid may be obtained: (1) from a variable cathode resistor as shown in Figs. 64 and 65; (2) from a bleeder circuit by means of a potentiometer as shown in Fig. 66; or (3) from a bleeder circuit in which the bleeder current is varied by a tube used for automatic volume control. The latter circuit is shown in Fig. 47. In all cases it is important that the control be arranged so that at no time will the bias be less than the recommended minimum grid-bias voltage for the particular tubes used. This requirement can be met by providing a fixed stop on the potentiometer, by connecting a fixed resistance in series with the variable resistance, or by connecting a fixed cathode resistance in series with the variable resistance used for regulation.

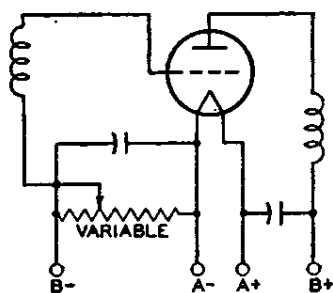

Fig. 64

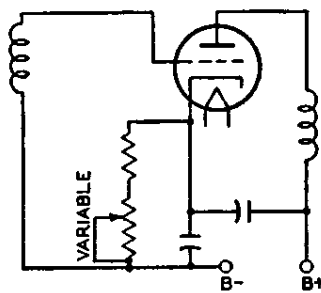

Fig. 65

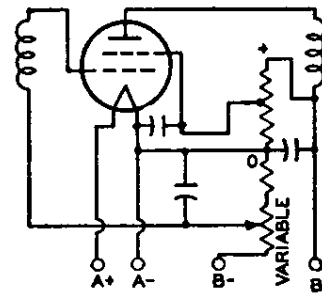

Fig. 66

Where receiver gain is controlled by grid-bias variation, it is advisable to have the control voltages extend over a wide range in order to minimize cross-modulation and modulation-distortion. A remote-cutoff type of tube should, therefore, be used in the controlled stages.

SCREEN VOLTAGE SUPPLY

The positive voltage for the screen (grid No. 2) of screen-grid tubes may be obtained from a tap on a voltage divider, from a potentiometer, or from a series resistor connected to a high-voltage source, depending on the structure of the

particular tube type and its application. The screen voltage for tetrodes should be obtained from a voltage divider or a potentiometer rather than through a series resistor from a high-voltage source because of the characteristic screen-current variations of tetrodes. Fig. 67 shows a tetrode with its screen voltage obtained from a potentiometer. When pentodes or beam power tubes are operated under conditions where a large shift of plate and screen currents does not take place with the application of the signal, the screen voltage may be obtained through a series resistor from a high-voltage source. This method of supply is possible because of the high uniformity of the screen-current characteristic in pentodes and beam power tubes. Because the screen voltage rises with increase in bias and resulting decrease in screen current, the cutoff characteristic of a pentode is extended by this method of supply. The method is sometimes used to increase the range of signals which can be handled by a pentode. When used in resistance-coupled amplifier circuits employing pentodes in combination with the cathode-biasing method, it minimizes the need for circuit adjustments. Fig. 68 shows a pentode with its screen voltage supplied through a series resistor.

When power pentodes and beam power tubes are operated under conditions such that there is a large change in plate and screen currents with the application of signal, the series-resistor method of obtaining screen voltage should not be used. A change in screen current appears as a change in the voltage drop across the series resistor in the screen circuit; the result is a change in the power output and an increase in distortion. The screen voltage should be obtained from a point in the plate-voltage-supply filter system having the correct voltage, or from a separate source.

It is important to note that the plate voltage of tetrodes, pentodes, and beam power tubes should be applied before or simultaneously with the screen voltage. Otherwise, with voltage on the screen only, the screen current may rise high enough to cause excessive screen dissipation.

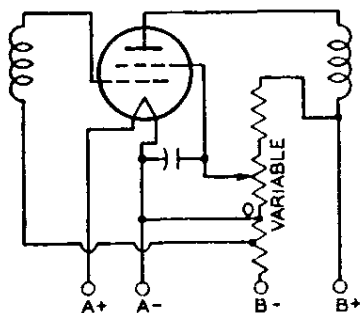

Fig. 67

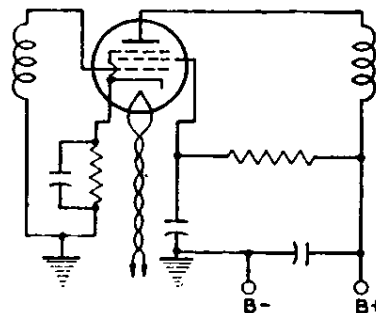

Fig. 68

Screen-voltage variation for the rf amplifier stages has sometimes been used for volume control in older-type receivers. Reduced screen voltage lowers the transconductance of the tube and results in reduced gain per stage. The voltage variation is obtained by means of a potentiometer shunted across the screen voltage supply. See Fig. 67. When the screen voltage is varied, it is essential that the screen voltage never exceed the rating of the tube. This requirement can be met by providing a fixed stop on the potentiometer.

SHIELDING

In high-frequency stages having high gain, the output circuit of each stage must be shielded from the input circuit of that stage. Each high-frequency stage also must be shielded from the other high-frequency stages. Unless shielding is employed, undesired feedback may occur and may produce many harmful effects on receiver performance. To prevent this feedback, it is a desirable practice to shield separately each unit of the high-frequency stages. For instance, in a super-heterodyne receiver, each if and rf coil may be mounted in a separate shield can.

Baffle plates may be mounted on the ganged tuning capacitor to shield each section of the capacitor from the other sections. The oscillator coil may be especially well shielded by being mounted under the chassis. The shielding precautions required in a receiver depend on the design of the receiver and the layout of the parts. In all receivers having high-gain high-frequency stages, it is necessary to shield separately each tube in high-frequency stages. When metal tubes, and in particular the single-ended types, are used, complete shielding of each tube is provided by the metal shell which is grounded through its grounding pin at the socket terminal. The grounding connection should be short and heavy. Many modern tubes of glass construction have internal shields connected usually to the cathode and where present are indicated in the socket diagram.

DRESS OF CIRCUIT LEADS

At high frequencies such as are encountered in FM and television receivers, lead dress, that is, the location and arrangement of the leads used for connections in the receiver, is very important. Because even a short lead provides a large impedance at high frequencies, it is necessary to keep all high-frequency leads as short as possible. This precaution is especially important for ground connections and for all connections to bypass capacitors and hf filter capacitors. The ground connections of plate and screen bypass capacitors of each tube should be kept short and made directly to cathode ground.

Particular care should be taken with the lead dress of the input and output circuits of an hf stage so that the possibility of stray coupling is minimized. Unshielded leads connected to shielded components should be dressed close to the chassis. As the frequency increases, the need for paying careful attention to lead dress becomes increasingly important.

In high-gain audio amplifiers, these same precautions should be taken to minimize the possibility of self-oscillation.

FILTERS

Feedback effects also are caused in radio receivers by coupling between stages through common voltage-supply circuits. Filters find an important use in minimizing such effects. They should be placed in voltage-supply leads to each tube in order to return the signal current through a low-impedance path direct to the tube cathode rather than by way of the voltage-supply circuit. Fig. 69 illustrates several forms of filter circuits. Capacitor C forms the low-impedance path, while the choke or resistor assists in diverting the signal through the capacitor by offering a high-impedance to the power-supply circuit.

The choice between a resistor and a choke depends chiefly upon the permissible dc voltage drop through the filter. In circuits where the current is small (a few milliamperes), resistors are practical; where the current is large or regulation important, chokes are more suitable.

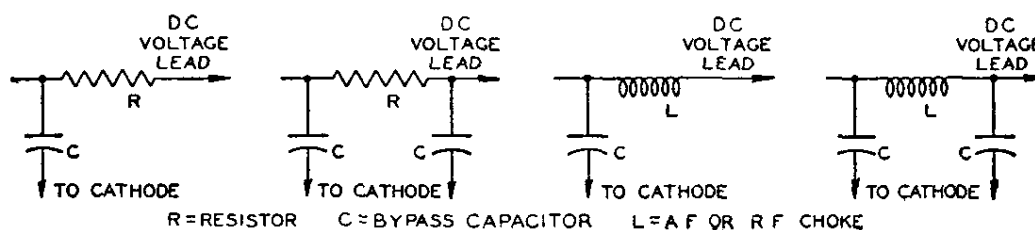

Fig. 69

The minimum practical size of the capacitors may be estimated in most cases by the following rule: The impedance of the capacitor at the lowest frequency amplified should not be more than one-fifth of the impedance of the filter choke or

resistor at that frequency. Better results will be obtained in special cases if the ratio is not more than one-tenth. Radio-frequency circuits, particularly at high frequencies, require high-quality capacitors. Mica capacitors are preferable. Where stage shields are employed, filters should be placed within the shield.

Another important application of filters is to smooth the output of a rectifier tube. See **Rectification**. A smoothing filter usually consists of capacitors and iron-core chokes. In any filter-design problem, the load impedance must be considered as an integral part of the filter because the load is an important factor in filter performance. Smoothing effect is obtained from the chokes because they are in series with the load and offer a high impedance to the ripple voltage. Smoothing effect is obtained from the capacitors because they are in parallel with the load and store energy on the voltage peaks; this energy is released on the voltage dips and serves to maintain the voltage at the load substantially constant. Smoothing filters are classified as choke-input or capacitor-input according to whether a choke or capacitor is placed next to the rectifier tube. See Fig. 70.

The **CIRCUIT SECTION** gives a number of examples of rectifier circuits with recommended filter constants.

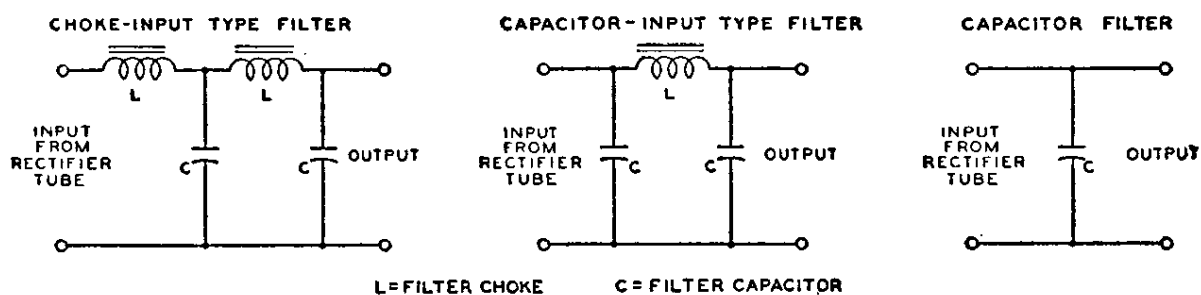

Fig. 70

If an input capacitor is used, consideration must be given to the instantaneous peak value of the ac input voltage. This peak value is about 1.4 times the RMS value as measured by an ac voltmeter. Filter capacitors, therefore, especially the input capacitor, should have a rating high enough to withstand the instantaneous peak value if breakdown is to be avoided. When the input-choke method is used, the available dc output voltage will be somewhat lower than with the input-capacitor method for a given ac plate voltage. However, improved regulation together with lower peak current will be obtained.

Mercury-vapor and gas-filled rectifier tubes occasionally produce a form of local interference in radio receivers through direct radiation or through the power line. This interference is generally identified in the receiver as a broadly tunable 120-cycle buzz (100 cycles for 50-cycle supply line, etc.). It is usually caused by the formation of a step wave front when plate current within the tube begins to flow on the positive half of each cycle of the ac supply voltage. There are several ways of eliminating this type of interference. One is to shield the tube. Another

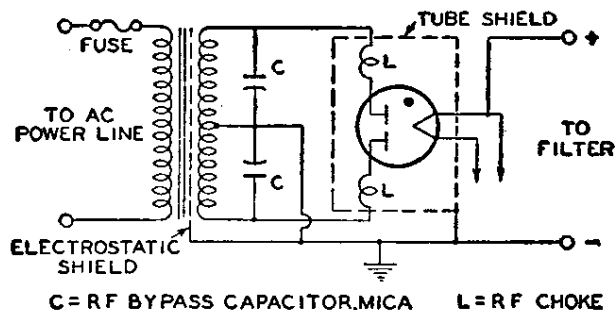

Fig. 71

is to insert an rf choke having an inductance of one millihenry or more between each plate and transformer winding and to connect high-voltage, rf bypass capaci-

tors between the outside ends of the transformer winding and the center tap. See Fig. 71. The rf chokes should be placed within the shielding of the tube. The rf bypass capacitors should have a voltage rating high enough to withstand the peak voltage of each half of the secondary, which is approximately 1.4 times the RMS value. Transformers having electrostatic shielding between primary and secondary are not likely to transmit rf disturbances to the line. Often the interference may be eliminated simply by making the plate leads of the rectifier extremely short. In general, the particular method of interference elimination must be selected by experiment for each installation.

OUTPUT-COUPLING DEVICES

An output-coupling device is used in the plate circuit of a power output tube to keep the comparatively high dc plate current from the winding of an electromagnetic speaker and, also, to transfer power efficiently from the output stage to a loudspeaker of either the electromagnetic or dynamic type.

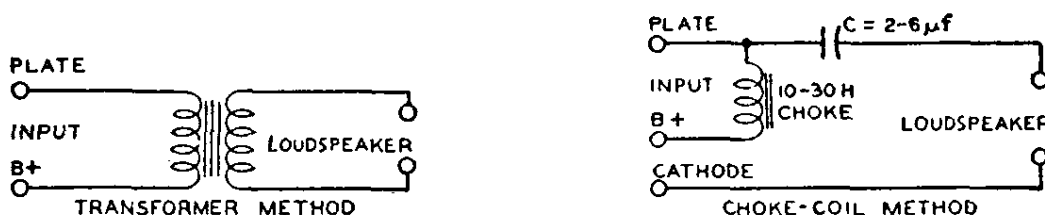

Fig. 72

Output-coupling devices are of two types, (1) choke-capacitor and (2) transformer. The choke-capacitor type includes an iron-core choke with an inductance of not less than 10 henrys which is placed in series with the plate and B-supply. The choke offers a very low resistance to the dc plate current component of the signal voltage but opposes the flow of the fluctuating component. A bypass capacitor of 2 to 6 μf supplies a path to the speaker winding for the signal voltage. The transformer type is constructed with two separate windings, a primary and a secondary wound on an iron core. This construction permits designing each winding to meet the requirements of its position in the circuit. Typical arrangements of each type of coupling device are shown in Fig. 72. Examples of transformers for push-pull stages are shown in several of the circuits given in the CIRCUIT SECTION.

Interpretation of Tube Data

The tube data given in the following TUBE TYPES SECTION include ratings, typical operation values, characteristics, and characteristic curves.

The values for grid-bias voltages, electrode voltages, and electrode supply voltages are given with reference to a specified datum point as follows: For types having filaments heated with dc, the negative filament terminal is taken as the datum point to which other electrode voltages are referred. For types having filaments heated with ac, the mid-point (i.e., the center tap on the filament-transformer secondary, or the mid-point on a resistor shunting the filament) is taken as the datum point. For types having unipotential cathodes indirectly heated, the cathode is taken as the datum point.

Electrode voltage and current ratings are in general self-explanatory, but a brief explanation of other ratings will aid in the understanding and interpretation of tube data.

Plate dissipation is the power dissipated in the form of heat by the plate as a result of electron bombardment. It is the difference between the power supplied to the plate of the tube and the power delivered by the tube to the load.

Screen dissipation is the power dissipated in the form of heat by the screen as

a result of electron bombardment. With tetrodes and pentodes, the power dissipated in the screen circuit is added to the power in the plate circuit to obtain the total B-supply input power.

Peak heater-cathode voltage is the highest instantaneous value of voltage that a tube can safely stand between its heater and cathode. This rating is applied to tubes having a separate cathode terminal and used in applications where excessive voltage may be introduced between heater and cathode.

Maximum peak inverse plate voltage is the highest instantaneous plate voltage which the tube can withstand recurrently in the direction opposite to that in which it is designed to pass current. For mercury-vapor tubes and gas-filled tubes, it is the safe top value to prevent arc-back in the tube operating within the specified temperature range. Referring to Fig. 73, when plate A of a full-wave rectifier tube is positive, current flows from A to C, but not from B to C, because B is negative. At the instant plate A is positive, the filament is positive (at high voltage) with respect to plate B. The voltage between the positive filament and the negative plate B is in inverse relation to that causing current flow. The peak value of this voltage is limited by the resistance and nature of the path between plate B and filament. The maximum value of this voltage at which there is no danger of breakdown of the tube is known as maximum peak inverse voltage. The relations between peak inverse voltage, RMS value of ac input voltage, and dc output voltage depend largely on the individual characteristics of the rectifier circuit and the power supply. The presence of line surges or any other transient, or wave-form distortion may raise the actual peak voltage to a value higher than that calculated for sine-wave voltages. Therefore, the actual inverse voltage, and not the calculated value, should be such as not to exceed the rated maximum peak inverse voltage for the rectifier tube. A calibrated cathode-ray oscillograph or a peak-indicating electronic voltmeter is useful in determining the actual peak inverse voltage. In single-phase, full-wave circuits with sine-wave input and with no capacitor across the output, the peak inverse voltage on a rectifier tube is approximately 1.4 times the RMS value of the plate voltage applied to the tube. In single-phase, half-wave circuits with sine-wave input and with capacitor input to the filter, the peak inverse voltage may be as high as 2.8 times the RMS value of the applied plate voltage. In polyphase circuits, mathematical determination of peak inverse voltage requires the use of vectors.

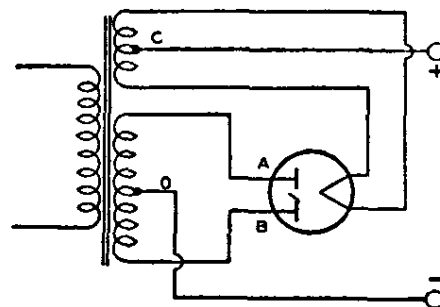

Fig. 73

Maximum peak plate current is the highest instantaneous plate current that a tube can safely carry recurrently in the direction of normal current flow. The safe value of this peak current in hot-cathode types of rectifier tubes is a function of the electron emission available and the duration of the pulsating current flow from the rectifier tube in each half-cycle.

The value of peak plate current in a given rectifier circuit is largely determined by filter constants. If a large choke is used at the filter input, the peak plate current is not much greater than the load current; but if a large capacitor is used at the filter input, the peak current may be many times the load current. In order to determine accurately the peak plate current in any rectifier circuit, measure it with a peak-indicating meter or use an oscillograph.

Maximum dc output current is the highest average plate current which can be handled continuously by a rectifier tube. Its value for any rectifier tube type is based on the permissible plate dissipation of that type. Under operating conditions

involving a rapidly repeating duty cycle (steady load), the average plate current may be measured with a dc meter.

Typical Operation Values. Values for typical operation are given for many types in the TUBE TYPES SECTION. These values should not be confused with ratings, because a tube can be used under any suitable conditions within its maximum ratings, according to the application.

The power output value for any operating condition is an approximate tube output—that is, plate input minus plate loss. Circuit losses must be subtracted from tube output in order to determine the useful output.

Characteristics are covered in the ELECTRON TUBE CHARACTERISTICS SECTION and such data should be interpreted in accordance with the definitions given in that section. *Characteristic curves* represent the characteristics of an average tube. Individual tubes, like any manufactured product, may have characteristics that range above or below the values given in the characteristic curves.

Although some curves are extended well beyond the maximum ratings of the tube, this extension has been made only for convenience in calculations. Do NOT operate a tube outside of its maximum ratings.

All tubes in this Manual are rated according to the “design-center system” as given in RMA Standard M8-210. This standard takes into account the normal voltage variations of the various power-supply sources used for modern radio receivers. The Standard M8-210, used with permission of the Engineering Department of the Radio Manufacturers Association, follows:

It shall be standard to interpret the ratings on receiving types of tubes according to the following conditions:

1. CATHODE—The heater or filament voltage is given as a normal value unless otherwise stated. This means that transformers or resistances in the heater or filament circuit should be designed to operate the heater or filament at rated value for full-load operating conditions under average supply-voltage conditions. A reasonable amount of leeway is incorporated in the cathode design so that moderate fluctuations of heater or filament voltage downward will not cause marked falling off in response; also moderate voltage fluctuations upward will not reduce the life of the cathode to an unsatisfactory degree.

A. 1.4-Volt Battery Tube Types—The filament power supply may be obtained from dry-cell batteries, from storage batteries, or from a power line. With dry-cell battery supply, the filament may be connected either directly across a battery rated at a terminal potential of 1.5 volts, or in series with the filaments of similar tubes across a power supply consisting of dry cells in series. In either case, the voltage across each 1.4-volt section of filament should not exceed 1.6 volts. With power-line or storage-battery supply, the filament may be operated in series with the filaments of similar tubes. For such operation, design adjustments should be made so that, with tubes of rated characteristics, operating with all electrode voltages applied and on a normal line voltage of 117 volts or on a normal storage-battery voltage of 2.0 volts per cell (without a charger) or 2.2 volts per cell (with a charger), the voltage drop across each 1.4-volt section of filament will be maintained within a range of 1.25 to 1.4 volts with a nominal center of 1.3 volts. In order to meet the recommended conditions for operating filaments in series from dry-battery, storage-battery, or power-line sources it may be necessary to use shunting resistors across the individual 1.4-volt sections of filament.

B. 2.0-Volt Battery Tube Types—The 2.0-volt line of tubes is designed to be operated with 2.0 volts across the filament. In all cases the operating voltage range should be maintained within the limits of 1.8 volts to 2.2 volts.

2. POSITIVE POTENTIAL ELECTRODES—The power sources for the operation of radio equipment are subject to variations in their terminal potential. Consequently, the maximum ratings shown on the tube-type data sheets have been established for certain Design Center Voltages which experience has shown to be representative. The Design Center Voltages to be used for the various power supplies together with other rating considerations are as given below:

A. AC or DC Power Line Service in U.S.A. The design center voltage for this type of power supply is 117 volts. The maximum ratings of plate voltages, screen-supply voltages, dissipations, and rectifier output currents are design maximums and should not be exceeded in equipment operated at a line voltage of 117 volts.

B. Storage-Battery Service—When storage-battery equipment is operated without a charger, it should be designed so that the published maximum values of plate voltages, screen-supply voltages, dissipations, and rectifier output currents are never exceeded for a terminal potential at the battery source of 2.0 volts per cell. When storage-battery equipment is operated with a charger, it should be designed so that 90% of the same maximum values is never exceeded for a terminal potential at the battery source of 2.2 volts.

C. "B"-Battery Service—The design center voltage for "B" batteries is the normal voltage rating of the battery block, such as 45 volts, 90 volts, etc. Equipment should be designed so that under no condition of battery voltage will the plate voltages, the screen-supply voltages, or dissipations ever exceed the recommended respective maximum values shown in the data for each tube type by more than 10%.

D. Other Considerations—

a. Class A₁ Amplifiers—The maximum plate dissipation occurs at the "Zero-Signal" condition. The maximum screen dissipation usually occurs at the condition where the peak-input signal voltage is equal to the bias voltage.

b. Class B Amplifiers—The maximum plate dissipation theoretically occurs at approximately 63% of the "Maximum-Signal" condition, but practically may occur at any signal voltage value.

c. Converters—The maximum plate dissipation occurs at the "Zero-Signal" condition and the frequency at which the oscillator-developed bias is a minimum. The screen dissipation for any reasonable variation in signal voltage must never exceed the rated value by more than 10%.

d. Screen Ratings—When the screen voltage is supplied through a series voltage-dropping resistor, the maximum screen voltage rating may be exceeded, provided the maximum screen dissipation rating is not exceeded at any signal condition, and the maximum screen voltage rating is not exceeded at the maximum-signal condition. Provided these conditions are fulfilled, the screen-supply voltage may be as high as, but not above, the maximum plate voltage rating.

3. TYPICAL OPERATION—For many receiving tubes, the data show typical operating conditions in particular services. These typical operating values are given to show concisely some guiding information for the use of each type. They are not to be considered as ratings, because the tube can be used under any suitable conditions within its rating limitations.

RCA Receiving Tube Classification Chart

RCA receiving tubes are classified in the following chart according to function and cathode voltage. Types having similar electrical characteristics are grouped

Cathode Volts		1.4	2.0	2.5—5.0	6.3	12.6—117	
KINESCOPIES							
Projection	magnetic deflection				5TP4		
Directly Viewed	magnetic deflection			9AP4 12AP4	7DP4 10BP4		
	electrostatic deflection				7JP4		
RECTIFIERS (For rectifiers with amplifier units, see POWER AMPLIFIERS).							
Half-Wave	vacuum	1B3-GT/ 8016*			1-v 81♠	12Z3 { 35W4 } 35Y4 { 35Z4-GT } 35Z3 { 35Z5-GT } 45Z3 { 45Z5-GT } 117Z3	
Full-Wave	vacuum			5T4, 5W4 [5U4-G, 5X4-G] 5Z3 [5Y3-GT, 5Y4-G] 80 5Z4 [5V4-G, 83-v]	[6X4, 6X5] [6X5-GT, 84/6Z4] 6ZY5-G 7Y4 7Z4		
	mercury-vapor			82 83			
	gas	Cold-Cathode Types: 0Z4, 0Z4-G					
Doubler	vacuum					[25Z5] 25Z6 [25Z6-GT] 50Y6-GT 117Z6-GT	
DIODE DETECTORS (For diode detectors with amplifier units, see VOLTAGE AMPLIFIERS and also POWER AMPLIFIERS).							
One Diode		1A3					
Two Diodes					6AL5 [6H6, 6H6-GT] 7A6	12H6 12AL5	
POWER AMPLIFIERS with and without Rectifiers, Diode Detectors, and Voltage Amplifiers.							
Triodes	low-mu	single unit		31 49	2A3 45 46 71-A	6B4-G 10♠ 6A3 50♠	
	high-mu	single unit				6AC5-GT	
		twin unit	1G6-GT	[1J6-G] 19	53	[6A6, 6N7] [6N7-GT]	6Z7-G 79
	direct-coupled arrangement						6B5
Beam Tubes	single unit	[1Q5-GT] 3Q5-GT* 1T5-GT 3LF4*				6BC6-G [6L6] [6L6-G] 6Y6-G 7A5 7C5 [6AQ5 6V6 6V6-GT]	14A5 [25L6] 35A5 [25L6-GT] [35B5 35L6-GT] 50A5 [50B5, 50L6-GT]
	with rectifier						32L7-GT 70L7-GT [117L7/M7-GT] 117P7-GT 117N7-GT
Pentodes	single unit	1A5-GT 1C5-GT 1LA4, 1LB4 [1S4, 3S4*] [3Q4*, 3V4*]	[1F4] [1F5-G] 1G5-G 1J5-G 33	2A5 47 59	6A4/LA [6AK6, 6G6-G] 6AG7 [6F6, 6F6-G, 6F6-GT, 42] [6K6-GT, 41]	7B5 38 89 [25A6] [43]	
	with medium-mu triode					6AD7-G	
	with diode and triode	1D8-GT					
	with rectifier					12A7	
	twin unit		1E7-G				

RCA RECEIVING TUBE MANUAL

in brackets. For more complete data on these types, refer to the TUBE TYPES SECTION. Information on *Preferred Types* and on *Types Not Recommended for New Equipment Design* will be found on the inside back cover.

Cathode Volts		1.4	2.0	2.5-5.0	6.3	12.6-117		
CONVERTERS & MIXERS (For other types used as Mixers, see VOLTAGE AMPLIFIERS).								
Converters	pentagrid	1A7-GT 1LA6 1LC6 1R5	[1C6 1C7-G 1A6 1D7-G]	2A7	[6A7, 6A8 6A8-G, 6A8-CT 6D8-G 6SB7-Y] [6BE6, 6SA7 6SA7-GT]	12A8-GT [12BE6, 12SA7 12SA7-GT 14B8 14Q7]		
	triode-hexode				[6K8, 6K8-G]	12K8		
	triode-heptode				6J8-G 7J7 7S7	14J7		
	octode				7A8			
Mixers	pentagrid				[6L7, 6L7-G]			
ELECTRON-RAY TUBES								
Single	with remote-cutoff triode				6AB5/6N5 6U5/6G5			
	with sharp-cutoff triode			2E5	6E5			
Twin	without triode				6AF6-G			
VOLTAGE AMPLIFIERS with and without Diode Detectors; TRIODE, TETRODE, AND PENTODE DETECTORS; OSCILLATORS.								
Triodes	medium- μ	single unit	1G4-GT 1LE3, 26 ^A	[1H4-G 30]	27 56	6C4 [6C5, 6C5-GT] [6P5-GT, 76 [6J5, 6J5-GT] 6L5-G, 7A4, 37	12J5-GT 14A4	
		with r f pentode				6F7		
		with power pentode					6AD7-G	
		with pentode and diode	1D8-GT 3A8-GT					
		with two diodes		[1B5/25S 1H6-G]	55	[6R7, 6R7-GT] [6BF6, 6SR7, 6ST7] 7E6 85	[12SR7 12SR7-GT] 14E6	
	twin unit				6C8-G [6F8-G, 6SN7-GT] 6J6 7N7 7F8 12AU7	12AH7-GT 12AU7 12SN7-GT 14N7		
	high- μ	single unit				[6F5, 6F5-GT] [6SF5, 6SF5-GT] 6K5-GT 7B4	[12F5-GT 12SF5]	
		with diode	1H5-GT 1LH4					
		with two diodes			2A6	[6SQ7, 6SQ7-GT] [6AT6, 6AQ6 6B6-G, 75] [6Q7, 6Q7-G 6T7-G, 7B6, 7C6] [6SZ7, 6Q7-GT]	[12AT6, 12Q7-GT] 14B6 [12SQ7, 12SQ7-GT]	
		with three diodes				6S8-GT		
twin unit					6SC7 6SL7-GT 7F7 12AX7	12SC7 12AX7 12SL7-GT 14F7		
Tetrodes	remote cutoff			35				
	sharp cutoff			32 24-A	36			
Pentodes	remote cutoff	single unit	1T4 1P5-GT	34 [1D5-GP 1A4-P]	58	[6K7, 6K7-G] [6D6] [6BA6, 6SC7] [6K7-GT, 78] [6U7-G] 6BJ6 6AB7/1853 [6S7] 7A7, 7B7 [6SK7] [6S7-G] 7H7 [6SK7-GT] 6SS7 39/44	[12BA6, 12SG7] [12SK7 12SK7-GT] 12K7-GT 14H7 14A7/12B7	
		with triode				6F7		
		with diode				6SF7	12SF7	
	with two diodes			2B7	[6B7 [6B8, 6B8-G]] 7E7 7R7	12C8, 14R7		
	sharp cutoff	single unit	1LC5, 1LN5 1L4, 1U4 1N5-GT	[1E5-GP 1B4-P 15]	57	[6J7, 6J7-G, 6J7-GT] [6SJ7 6C6, 6W7-G, 77] [6SJ7-GT] [6AU6] 6AC7/1852 6AG5 [6SH7] 7C7/1232 7C7 7L7 7V7 7W7	[12AU6, 12SH7] 12AW6 [12SJ7 12SJ7-GT] 12J7-GT 14C7	
		with diode	1LD5 [1S5, 1U5]					
with two diodes			[1F6 1F7-G]					

● Cathode volts, 1.25.

▲ Cathode volts, 1.5.

◆ Cathode volts, 7.5.

*Filament arranged for either 1.4 or 2.8-volt operation.

RCA Miniature Tubes

For the convenience of the reader, a complete list of RCA Miniature Tubes, classified according to function, follows. This list includes not only tube types designed for home receiving instruments, but also tube types designed for specialized applications. The latter types, marked with an asterisk, are not included in this Manual. Information on them, however, will gladly be furnished on request

RECTIFIERS, Vacuum Types

Half-Wave.....	} 35W4, 45Z3 117Z3, 1654*
Full-Wave.....	

DIODE DETECTORS

Single Unit.....	1A3, 9006*
Twin Unit.....	6AL5, 12AL5

TRIODE AMPLIFIERS

Single Unit.....	6C4, 6J4*, 9002*
Twin Unit.....	} 3A5*, 6J6 12AU7, 12AX7

DIODE-TRIODE AMPLIFIERS

High-Mu.....	6AQ6, 6AT6, 12AT6
Medium-Mu.....	6BF6, 26C6*

PENTODE VOLTAGE AMPLIFIERS

Sharp-Cutoff.....	} 1L4, 1S5, 1U4 1U5, 6AG5, 6AK5* 6AU6, 12AU6 12AW6, 9001*	
Remote-Cutoff.....		} 1T4, 6BA6, 6BJ6 12BA6, 26A6*, 9003*

PENTODE POWER AMPLIFIERS.....	} 1S4, 3A4*, 3Q4 3S4, 3V4, 6AK6
-------------------------------	------------------------------------

BEAM POWER AMPLIFIERS.....	6AQ5, 35B5, 50B5
----------------------------	------------------

PENTAGRID CONVERTERS.....	} 1R5, 6BE6 12BE6, 26D6*
---------------------------	-----------------------------

THYRATRON.....	2D21*
----------------	-------

VOLTAGE REGULATORS.....	OA2*
-------------------------	------

RCA Tube Types

This section contains technical descriptions of RCA tubes used in standard broadcast, FM, and television receivers. It includes data on current types, as well as information on those RCA discontinued types in which there may still be some interest as to characteristics.

In choosing tube types for the design of new electronic equipment, the designer is referred to the inside back cover for information regarding the availability of the latest **RCA Preferred Types List** and for a listing of **RCA Tube Types Not Recommended for New Equipment Design**.

Tube types are listed in this section according to the numerical-alphabetical sequence of their type designations. For **Key to Socket Connection Diagrams**, see inside front cover.

DETECTOR AMPLIFIER TRIODE

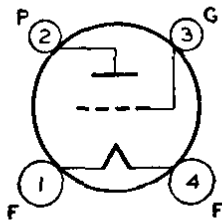

Storage-battery triode used as detector or amplifier. Outline 29, OUTLINES SECTION. Operating conditions as grid-resistor detector are: plate volts, 45 *max*; grid resistor, 2 to 3 megohms; grid capacitor, 250 μmf ; grid return to (+) filament. As biased detector, type 01-A has plate volts of 135 *max*; bias of approximately -13.5 volts. As amplifier, it has plate volts of 135 *max*; bias of -9 volts. Filament volts, 5; amperes, 0.25. This is a DISCONTINUED type listed for reference only.

01-A

FULL-WAVE GAS RECTIFIER

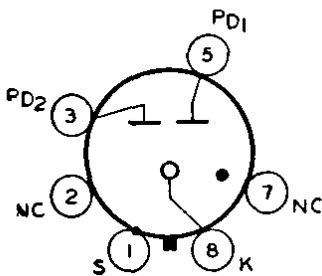

Metal type OZ4 and glass octal type OZ4-G are used in vibrator-type, B-supply units. Both are cold-cathode types, require octal sockets, and may be mounted in any position. OZ4 Outline 2, OUTLINES SECTION. OZ4-G dimensions: maximum overall length, 2-5/8 inches; maximum diameter, 1-1/16 inches; T-7 bulb; dwarf-shell octal 5-pin base. Shell of OZ4 and external shield of OZ4-G should be grounded. Filters may be necessary to eliminate objectionable noise. These types are used principally for renewal purposes.

OZ4

OZ4-G

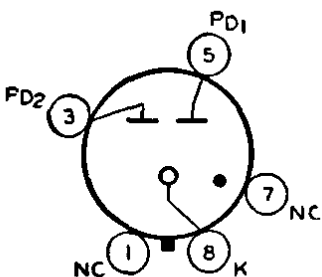

FULL-WAVE RECTIFIER

Maximum Ratings:

PEAK STARTING SUPPLY VOLTAGE PER PLATE.....	300 <i>min</i>	volts
PEAK PLATE-TO-PLATE VOLTAGE.....	1000 <i>max</i>	volts
PEAK PLATE CURRENT.....	200 <i>max</i>	ma
DC OUTPUT CURRENT.....	{ 75 <i>max</i>	ma
	{ 30 <i>min</i>	ma
DC OUTPUT VOLTAGE.....	300 <i>max</i>	volts
AVERAGE DYNAMIC TUBE VOLTAGE DROP.....	24	volts

1A3

HF DIODE

Miniature type used as detector tube in portable FM receivers and in portable high-frequency measuring equipment. Outline 10, OUTLINES SECTION. Tube requires miniature seven-contact socket. Heater volts (ac/dc), 1.4; amperes, 0.15.

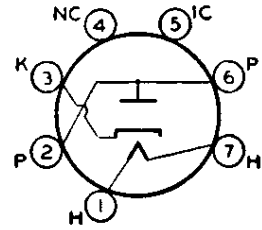

Maximum Ratings:

PEAK INVERSE PLATE VOLTAGE.....	330 max	volts
PEAK PLATE CURRENT.....	5 max	ma
DC OUTPUT CURRENT.....	0.5 max	ma
PEAK HEATER-CATHODE VOLTAGE.....	140 max	volts

HALF-WAVE RECTIFIER

Typical Operation (With Capacitor-Input Filter):

AC Plate-Supply Voltage (RMS).....	117	volts
Filter-Input Capacitor.....	2	μf
Minimum Total Effective Plate-Supply Impedance.....	0	ohms

1A4-P

REMOTE-CUTOFF PENTODE

Glass type used in battery-operated receivers as rf or if amplifier. For ratings and operating data, refer to type 1D5-GP. Outline 27, OUTLINES SECTION. Tube requires four-contact socket. Filament volts (dc), 2.0; amperes, 0.06. This type is used principally for renewal purposes.

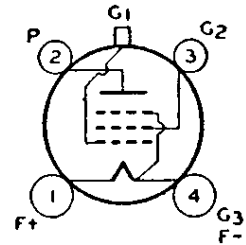

POWER PENTODE

1A5-GT

Glass octal type used in output stage of battery-operated receivers. Outline 17, OUTLINES SECTION. Tube requires octal socket and may be mounted in any position. For filament considerations, refer to 1U4.

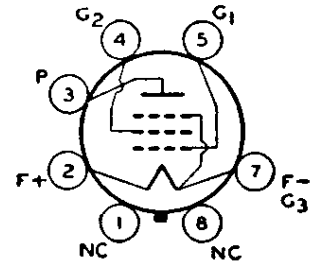

FILAMENT VOLTAGE (DC).....	1.4	volts
FILAMENT CURRENT.....	0.05	ampere

Maximum Ratings:

CLASS A₁ AMPLIFIER

PLATE VOLTAGE.....	110 max	volts
GRID-NO.2 (SCREEN) VOLTAGE.....	110 max	volts
TOTAL ZERO-SIGNAL CATHODE CURRENT.....	6 max	ma

Typical Operation:

Plate Voltage.....	85	90	volts
Grid-No.2 Voltage.....	85	90	volts
Grid-No.1 (Control-Grid) Voltage.....	-4.5	-4.5	volts
Peak AF Grid-No.1 Voltage.....	4.5	4.5	volts
Zero-Signal Plate Current.....	3.5	4.0	ma
Maximum-Signal Plate Current.....	3.5	4.0	ma
Zero-Signal Grid-No.2 Current.....	0.7	0.8	ma
Maximum-Signal Grid-No.2 Current.....	1.0	1.1	ma
Plate Resistance (Approx.).....	0.3	0.3	megohm
Transconductance.....	800	850	μmhos
Load Resistance.....	25000	25000	ohms
Total Harmonic Distortion.....	10	7	per cent
Maximum-Signal Power Output.....	100	115	mw

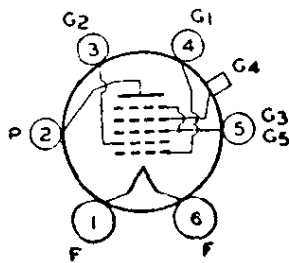

PENTAGRID CONVERTER

Glass type used in battery-operated receivers. Type 1A6 is identical electrically with type 1D7-G, except for interelectrode capacitances. Outline 27, OUTLINES SECTION. Tube requires six-contact socket. Filament volts (dc), 2.0; amperes, 0.06. This type is used principally for renewa purposes.

1A6

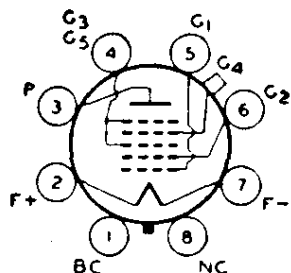

PENTAGRID CONVERTER

Glass octal type used in superheterodyne circuits having battery power supplies. Outline 18, OUTLINES SECTION. Tube requires octal socket and may be mounted in any position. For filament considerations, refer to 1U4.

1A7-GT

FILAMENT VOLTAGE (DC).....	1.4	volts
FILAMENT CURRENT.....	0.05	ampere

Maximum Ratings:

CONVERTER SERVICE

PLATE VOLTAGE.....	110 max	volts
GRIDS-NO.3-AND-NO.5 (SCREEN) VOLTAGE.....	60 max	volts
GRIDS-NO.3-AND-NO.5 SUPPLY VOLTAGE.....	110 max	volts
GRID-NO.2 (ANODE-GRID) VOLTAGE.....	110 max	volts
TOTAL ZERO-SIGNAL CATHODE CURRENT.....	6 max	ma

Typical Operation:

Plate Voltage.....	90	volts
Grids-No.3-and-No.5 Voltage*.....	45	volts
Grid-No.2 Voltage.....	90	volts
Grid-No.4 (Control-Grid) Voltage**.....	0	volts
Grid-No.1 (Oscillator-Grid) Resistor.....	0.2	megohm
Plate Resistance.....	0.6	megohm
Conversion Transconductance.....	250	μmhos
Conversion Transconductance with grid-No.4 bias of -3 volts (Approx.).....	20	μmhos
Plate Current.....	0.6	ma
Grids-No.3-and-No.5 Current.....	0.7	ma
Grid-No.2 Current.....	1.2	ma
Grid-No.1 Current.....	0.035	ma
Total Cathode Current.....	2.5	ma

* Obtained preferably by using a bypassed 45000- to 75000-ohm voltage-dropping resistor in series with the 90-volt supply.

** A resistance of at least 1.0 megohm should be in the grid return to negative filament pin.

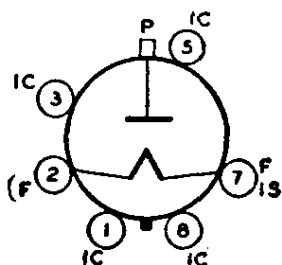

HALF-WAVE VACUUM RECTIFIER

Glass octal type used in high-voltage, low-current applications such as the rectifier in the high-voltage, rf-operated power supply for the kinescope, or as a rectifier of high-voltage pulses

**1B3-GT/
8016**

produced in the scanning system for the kinescope. When used as an rf rectifier, one 1B3-GT in a half-wave circuit is capable of delivering a maximum dc output voltage of about 20000 volts. In a voltage-doubler circuit, two tubes will give about 40000 volts; and in a voltage-tripler circuit, three 1B3-GT's will deliver 60000 volts approximately.

FILAMENT VOLTAGE (AC)	1.25	volts
FILAMENT CURRENT	0.2	ampere
DIRECT INTERELECTRODE CAPACITANCE (No external shield):		
Plate to Filament (Approx.)	1.2	$\mu\mu\text{f}$

Maximum Ratings:

HALF-WAVE RECTIFIER

PEAK INVERSE PLATE VOLTAGE	40000 <i>max</i>	volts
PEAK PLATE CURRENT	17 <i>max</i>	ma
AVERAGE PLATE CURRENT	2 <i>max</i>	ma
FREQUENCY OF SUPPLY VOLTAGE	300 <i>max</i>	kc

INSTALLATION AND APPLICATION

Tube requires octal socket and may be mounted in any position. Plate connection is cap at top of bulb. Internal connections are made to pins 1, 3, 5, and 7 which should not be used. Outline 22, OUTLINES SECTION.

When the filament is to be operated on rf, it is recommended that the filament be connected first to a dc or low-frequency ac supply of 1.25 volts. The color temperature of the filament corresponding to this voltage may then be checked visually by observing in a darkened room the reflection of the incandescent filament upon the upper surface of the internal shield. A visual comparison of this color temperature with that obtained with the filament operated from an rf voltage provides a convenient means for adjusting the amount of rf excitation to produce 1.25 volts (RMS) at the filament terminals. The filament must never, under any conditions of operation, be allowed to reach a temperature higher than that caused by operating the filament on dc or low-frequency ac at a voltage of 1.5 volts. Operation at higher temperatures, even momentarily during circuit adjustments, is certain to cause impaired performance of the tube even though the filament still lights.

The filament transformer, whether it is of the iron-core or the air-core type, must have sufficient insulation to withstand the maximum peak inverse plate voltage encountered in the installation.

The high voltages at which the 1B3-GT is operated are very dangerous. Great care should be taken to prevent coming in contact with these high voltages. In those circuits where the filament circuit is not grounded, the filament circuit operates at dc potentials which can cause fatal shock. Extreme precautions must be taken when the filament voltage is measured. These precautions must include safeguards which definitely eliminate all hazards to personnel.

SHARP-CUTOFF PENTODE

Glass type used as rf amplifier or detector in battery-operated receivers. Outline 27, OUTLINES SECTION. Tube requires four-contact socket. For typical operating conditions and maximum ratings as a class A₁ amplifier, refer to type 1E5-GP. Filament volts (dc), 2.0; amperes, 0.06. This type is used principally for renewal purposes.

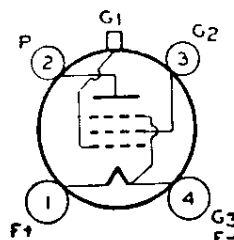

1B4-P

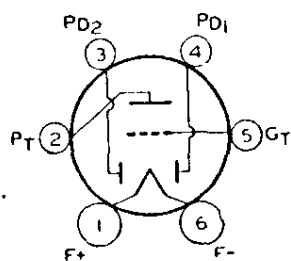

TWIN DIODE—MEDIUM-MU TRIODE

Glass type used as combined detector, amplifier, and avc tube in battery-operated receivers. Outline 25, OUTLINES SECTION. Tube requires six-contact socket. Filament volts (dc), 2.0; amperes, 0.06. Typical operation as class A₁ amplifier: plate volts, 135 *max*; grid volts, -3; plate ma., 0.8; plate resistance 35000, ohms; amplification factor, 20; transconductance, 575 μ mhos. This type is used principally for renewal purposes.

1B5/25S

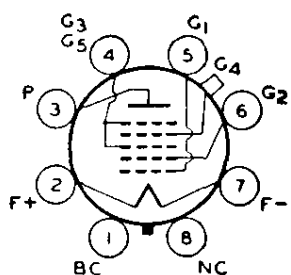

PENTAGRID CONVERTER

Glass octal type used in superheterodyne circuits having battery power supply. Outline 18, OUTLINES SECTION. Filament volts (dc), 1.4; amperes, 0.1. This is a DISCONTINUED type listed for reference only. The 1B7-GT may be replaced by the 1A7-GT if circuit adjustment is made for lower filament current of type 1A7-GT.

1B7-GT

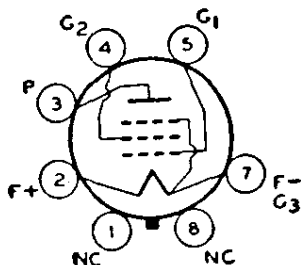

POWER PENTODE

Glass octal type used in output stage of battery-operated receivers. Outline 17, OUTLINES SECTION. Tube requires octal socket and may be mounted in any position. For filament considerations, refer to 1U4.

1C5-GT

FILAMENT VOLTAGE (DC).....	1.4	volts
FILAMENT CURRENT.....	0.1	ampere

CLASS A₁ AMPLIFIER

Maximum Ratings:			
PLATE VOLTAGE.....	110 <i>max</i>	volts	
GRID-NO.2(SCREEN) VOLTAGE.....	110 <i>max</i>	volts	
TOTAL ZERO-SIGNAL CATHODE CURRENT.....	12 <i>max</i>	ma	

Typical Operation:

Plate Voltage.....	83	90	volts
Grid-No.2 Voltage.....	83	90	volts
Grid-No.1 (Control-Grid) Voltage.....	-7.0	-7.5	volts
Peak AF Grid-No.1 Voltage.....	7.0	7.5	volts
Zero-Signal Plate Current.....	7.0	7.5	ma
Maximum-Signal Plate Current.....	7.3	7.8	ma
Zero-Signal Grid-No.2 Current.....	1.6	1.6	ma
Maximum-Signal Grid-No.2 Current.....	3.5	3.5	ma
Plate Resistance (Approx.).....	110000	115000	ohms
Transconductance.....	1500	1550	μ mhos
Load Resistance.....	9000	8000	ohms
Total Harmonic Distortion.....	10	10	per cent
Maximum-Signal Power Output.....	200	240	mw

PENTAGRID CONVERTER

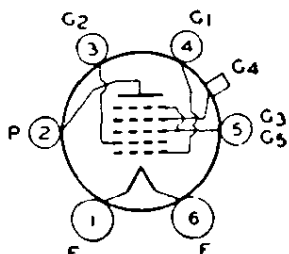

Glass type used in battery-operated receivers. Similar electrically to type 1C7-G except for interelectrode capacitances. Outline 27, OUTLINES SECTION. Tube requires six-contact socket. Filament volts (dc), 2.0; amperes, 0.12. For general discussion of pentagrid types, refer to Frequency Conversion in ELECTRON TUBE APPLICATIONS SECTION. This type is used principally for renewal purposes.

1C6

PENTAGRID CONVERTER

1C7-G

Glass octal type used in battery-operated receivers. Outline 26, OUTLINES SECTION. Tube requires octal socket. Filament volts (dc), 2.0; amperes, 0.12. Typical operation as converter: plate volts, 180 *max*; grids-No.3-and-No.5 (screen) volts, 180 (applied through 20000-ohm dropping resistor bypassed by 0.01- μ f capacitor); grid-No.4 (control-grid) volts, -3; grid-No.1 (oscillator-grid) resistor, 50000 ohms; plate ma.,

1.5; grids-No.3-and-No.5 ma., 2; grid-No.2 ma., 4; grid-No.1 ma., 0.2. This type is used principally for renewal purposes.

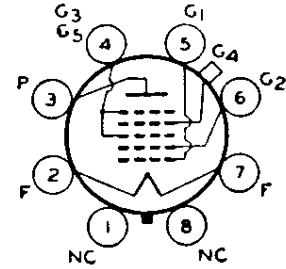

REMOTE-CUTOFF PENTODE

1D5-GP

Glass octal type used in battery-operated receivers as rf or if amplifier. Outline 26, OUTLINES SECTION. Tube requires octal socket. Filament volts (dc), 2.0; amperes, 0.06. Typical operation as class A₁ amplifier: plate volts, 180 *max*; grid-No.2 (screen) volts, 67.5 *max*; grid-No.1 volts, -3 *min*; plate ma., 2.3; grid-No.2 ma., 0.8; plate resistance (approx.), 1.0 megohm; transconductance, 750 μ mhos; transconductance at bias of -15 volts, 15 μ mhos. This type is used principally for renewal purposes.

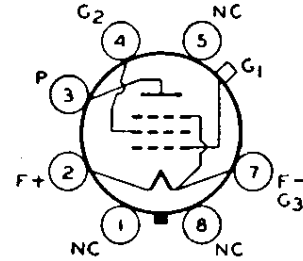

REMOTE-CUTOFF TETRODE

1D5-GT

Glass octal type used in battery-operated receivers as rf or if amplifier. Outline 26, OUTLINES SECTION. Filament volts (dc), 2.0; amperes, 0.06. This is a DISCONTINUED type listed for reference only. It can be replaced by type 1D5-GP.

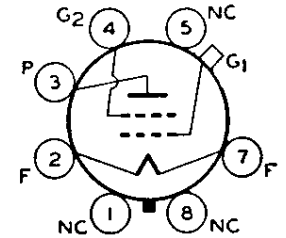

PENTAGRID CONVERTER

1D7-G

Glass octal type used in battery-operated receivers. Outline 26, OUTLINES SECTION. Tube requires octal socket. Filament volts (dc), 2.0; amperes, 0.06. Typical operation as converter: plate volts, grids-No.3-and-No.5 volts, grid-No.2 supply volts, grid-No.4 volts, and grid-No.1 resistor are same as for type 1C7-G; plate ma., 1.3; grids-No.3-and-No.5 ma., 2.4; grid-No.2 ma., 2.3; grid-No.1 ma., 0.2. This type is used principally for renewal purposes.

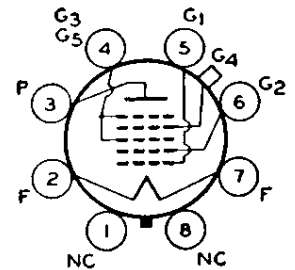

DIODE—TRIODE—POWER PENTODE

1D8-GT

Glass octal type used in compact battery-operated receivers. Diode unit is used as detector or avc tube, triode as first audio amplifier, and pentode as power output tube. Outline 16, OUTLINES SECTION. Tube requires octal socket. Filament volts (dc), 1.4; amperes, 0.1. Maximum plate volts of triode as well as maximum plate and grid-No.2 volts of pentode, 110.

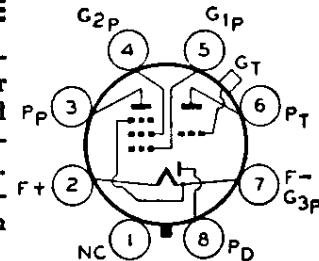

CLASS A₁ AMPLIFIER

Typical Operation (Pentode Unit):

Plate Voltage	45	67.5	90	volts
Grid-No.2 (Screen) Voltage	45	67.5	90	volts
Grid-No.1 (Control-Grid) Voltage	-4.5	-6	-9	volts
Plate Current	1.6	3.8	5	ma
Grid-No.2 Current	0.3	0.8	1.0	ma
Transconductance	650	875	925	μ mhos
Load Resistance	20000	16000	12000	ohms
Total Harmonic Distortion	10	10	10	per cent
Power Output	35	100	200	mw

Typical Operation (Triode Unit):

Plate Voltage.....	45	67.5	90	volts
Grid Voltage.....	0	0	0	volts
Amplification Factor.....	25	25	25	
Plate Resistance (Approx.).....	77000	55500	43500	ohms
Transconductance.....	325	450	575	μ mhos
Plate Current.....	0.3	0.6	1.1	ma

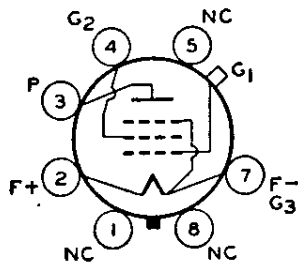

SHARP-CUTOFF PENTODE

Glass octal type used as rf amplifier or detector in battery-operated receivers. Outline 26, OUTLINES SECTION. Tube requires octal socket. Filament volts (dc), 2.0; amperes, 0.06. Typical operation as class A₁ amplifier: plate volts, 180 *max*; grid-No.2 (screen) volts, 67.5 *max*; grid-No.1 volts, -3; plate ma., 1.7; grid-No.2 ma., 0.6; plate resistance, 1.3 megohms; transconductance, 650 μ mhos; grid volts for plate-current cutoff (approx.), -8. This type is used principally for renewal purposes.

1E5-GP

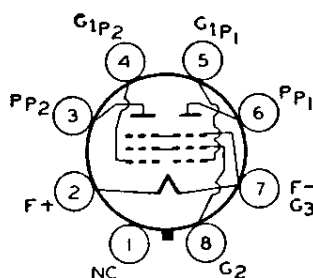

TWIN POWER PENTODE

Glass octal type used in push-pull output stage of battery-operated receivers. Outline 24, OUTLINES SECTION. Tube requires octal socket. Filament volts (dc), 2.0; amperes, 0.24. Typical operation as push-pull class A₁ amplifier: plate and grid-No.2 volts, 135 *max*; grid-No.1 volts, -7.5; plate ma., 10.5; grid-No.2 ma., 3.5; output watts, 0.575. The two units are used in the same manner as two separate tubes in conventional push-pull audio-frequency amplifier circuits. This type is used principally for renewal purposes.

1E7-G

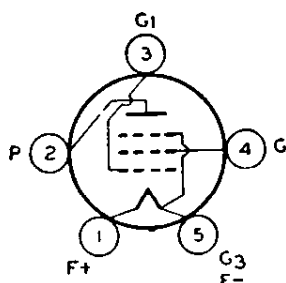

POWER PENTODE

Glass type used in output stage of battery-operated receivers. Outline 29, OUTLINES SECTION. Tube requires five-contact socket. Filament volts (dc), 2.0; amperes, 0.12. Type 1F4 is similar electrically to type 1F5-G. This type is used principally for renewal purposes.

1F4

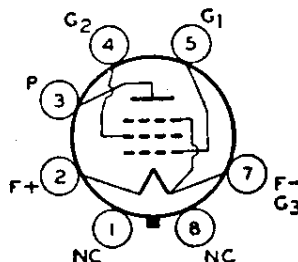

POWER PENTODE

Glass octal type used in output stage of battery-operated receivers. Outline 28, OUTLINES SECTION. Tube requires octal socket. Filament volts (dc), 2.0; amperes, 0.12. Typical operation as class A₁ amplifier: plate and grid-No.2 (screen) volts, 135 (180 *max*); grid-No.1 volts, -4.5; plate ma., 8; grid-No.2 ma., 2.4; cathode resistor, 432 ohms; output watts, 0.31. This type is used principally for renewal purposes.

1F5-G

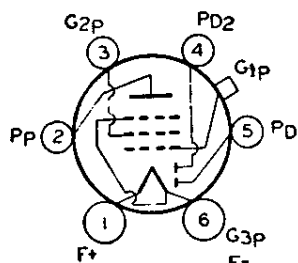

TWIN DIODE— SHARP-CUTOFF PENTODE

Glass type used as combined detector, amplifier, and avc tube in battery-operated receivers. Outline 27, OUTLINES SECTION. Tube requires six-contact socket. Filament volts (dc), 2.0; amperes, 0.06. This type is similar electrically to type 1F7-G, except for inter-electrode capacitances. Typical operation of pentode unit as class A₁ amplifier: plate volts,

1F6

180 *max*; grid-No.2 (screen) volts, 67.5 *max*; grid-No.1 volts, -1.5; plate ma., 2.2; grid-No.2 ma. 0.7. This type is used principally for renewal purposes.

**TWIN DIODE—
SHARP-CUTOFF PENTODE**

1F7-G

Glass octal type used as combined detector, amplifier, and avc tube in battery-operated receivers. Outline 26, OUTLINES SECTION. Tube requires octal socket. Filament volts (dc), 2.0; amperes, 0.06. Similar electrically to type 1F6 except for interelectrode capacitances. This type is used principally for renewal purposes.

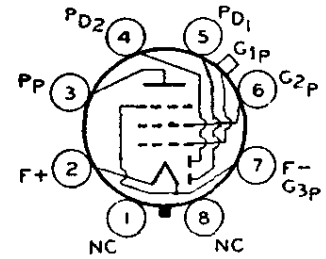

MEDIUM-MU TRIODE

1G4-GT

Glass octal type used in battery-operated receivers as detector or voltage amplifier. Outline 17, OUTLINES SECTION. Tube requires octal socket. Filament volts (dc), 1.4; amperes, 0.05. Typical operation and characteristics as class A₁ amplifier: plate volts, 90 (110 max); grid volts, -6; plate ma., 2.3; plate resistance, 10700 ohms; amplification factor, 8.8; transconductance, 825 μmhos. This type has been used as a driver for type 1G6-GT.

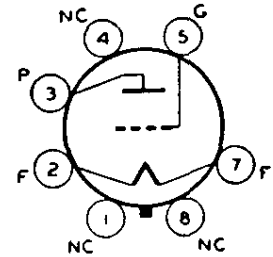

POWER PENTODE

1G5-G

Glass octal type used in output stage of battery-operated receivers. Outline 28, OUTLINES SECTION. Tube requires octal socket. Filament volts (dc), 2.0; amperes, 0.12. Typical operation as class A₁ amplifier: plate and grid-No.2 (screen) volts, 135 max; grid-No.1 volts, -13.5; plate ma., 9.7; output watts, 0.55. This type is used principally for renewal purposes.

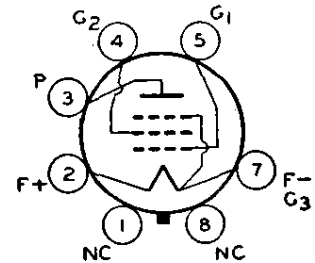

HIGH-MU TWIN POWER TRIODE

1G6-GT

Glass octal type used in output stage of battery-operated receivers. Outline 17, OUTLINES SECTION. Tube requires octal socket. Filament volts (dc), 1.4; amperes, 0.1. Typical operation as class B amplifier: plate volts, 90 (110 max); dc grid volts, 0; peak af grid-to-grid volts, 48; effective grid-circuit impedance per unit, 2530 ohms; plate ma. (zero signal), 2; plate ma. (maximum signal), 11; peak grid ma. per unit, 6; output watts (approx.), 0.35.

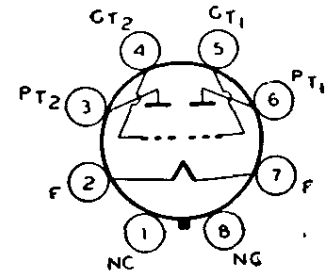

MEDIUM-MU TRIODE

1H4-G

Glass octal type used as detector or voltage amplifier in battery-operated receivers. Outline 24, OUTLINES SECTION. Tube requires octal socket. Filament volts (dc), 2.0; amperes, 0.06. Typical operation as class A₁ amplifier: plate volts, 180 max; grid volts, -13.5; amplification factor, 9.3; plate resistance, 10300 ohms; transconductance, 900 μmhos; plate ma., 3.1. For grid-bias detection, plate volts up to 180 max may be used and grid bias adjusted so that zero-signal plate ma. is about 0.2. This type is used principally for renewal purposes.

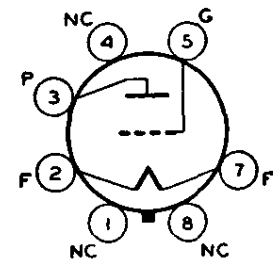

DIODE—HIGH-MU TRIODE

1H5-GT

Glass octal type used as combined detector and amplifier in battery-operated receivers. Outline 18, OUTLINES SECTION. Tube requires octal socket. Filament volts (dc), 1.4; amperes, 0.05. Characteristics of triode unit as class A₁ amplifier: plate volts, 110 max; grid volts, 0; plate ma., 0.15; plate resistance, 240000 ohms; amplification factor, 65; transconductance, 275 μmhos. Diode unit is located at negative end of filament and is independent of the triode unit except for common filament.

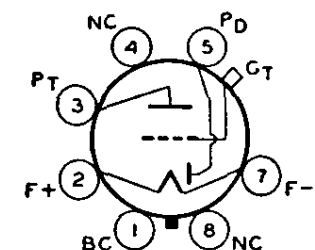

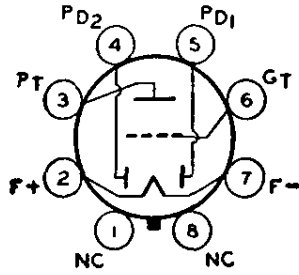

TWIN DIODE—MEDIUM-MU TRIODE

Glass octal type used as combined detector, amplifier, and avc tube in battery-operated receivers. Outline 24, OUTLINES SECTION. Tube requires octal socket. Filament volts (dc), 2.0; amperes, 0.06. Type 1H6-G is similar electrically to type 1B5/25S. This type is used principally for renewal purposes.

1H6-G

POWER PENTODE

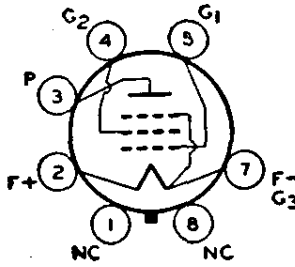

Glass octal type used in output stage of battery-operated receivers. Outline 28, OUTLINES SECTION. Tube requires octal socket. Filament volts (dc), 2.0; amperes, 0.12. Typical operation as class A₁ amplifier: plate and grid-No.2 (screen) volts, 135 max; grid-No.1 volts, -16.5; plate ma., 7.0; grid-No.2 ma., 2.0; plate resistance, 105000 ohms; load resistance, 13500 ohms; output watts, 0.45. This type is used principally for renewal purposes.

1J5-G

HIGH-MU TWIN POWER TRIODE

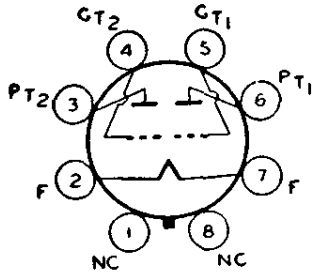

Glass octal type used in output stage of battery-operated receivers. Outline 24, OUTLINES SECTION. Tube requires octal socket. Filament volts (dc), 2.0; amperes, 0.24. Typical operation as class B power amplifier: plate volts, 135 max; peak plate ma. per plate, 50 max; grid volts, 0; zero-signal plate ma. per plate, 5; effective plate-to-plate load resistance, 10000 ohms; average input watts (approx.), 0.17; output watts (approx.), 2.1.

1J6-G

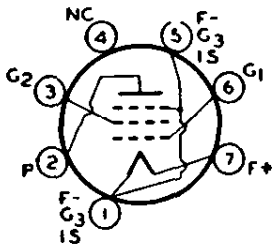

SHARP-CUTOFF PENTODE

Miniature type used as rf or if amplifier in portable, battery-operated receivers particularly those not utilizing avc. Outline 10, OUTLINES SECTION. Tube requires miniature seven-contact

1L4

socket and may be mounted in any position. Internal shield eliminates need for external bulb shield, but shielding the socket is essential if minimum grid-to-plate capacitance is required. For typical operation as a resistance-coupled amplifier, refer to Chart 1, RESISTANCE-COUPLED AMPLIFIER SECTION. For filament considerations, refer to type 1U4.

FILAMENT VOLTAGE (DC)	1.4	volts
FILAMENT CURRENT	0.05	ampere
DIRECT INTERELECTRODE CAPACITANCES (No external shield):		
Grid No.1 to Plate	0.01 max	μf
Input	3.6	μf
Output	7.5	μf

Maximum Ratings:

CLASS A₁ AMPLIFIER

PLATE VOLTAGE	110 max	volts
GRID-NO.2 (SCREEN) VOLTAGE	90 max	volts
GRID-NO.2 SUPPLY VOLTAGE	110 max	volts
GRID-NO.1 (CONTROL-GRID) VOLTAGE	0 min	volts
TOTAL CATHODE CURRENT	6.5 max	ma

Typical Operation:

Plate Voltage.....	90	90	volts
Grid-No.2 Voltage.....	67.5	90	volts
Grid-No.1 Voltage.....	0	0	volts
Plate Resistance.....	0.6	0.26	megohm
Transconductance.....	925	1025	μ mhos
Grid Bias for plate current of 10 μ a.....	-6	-10	volts
Plate Current.....	2.9	4.5	ma
Grid-No. 2 Current.....	1.2	2.0	ma

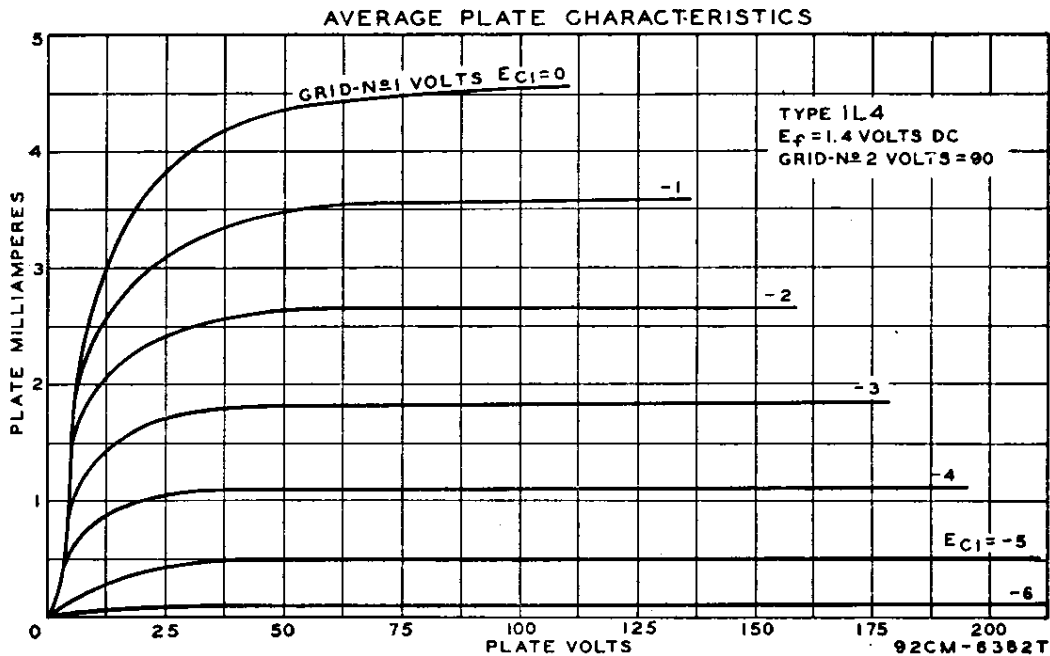

1LA4

POWER PENTODE

Glass lock-in type used in output stage of battery-operated receivers. Outline 12, OUTLINES SECTION. Tube requires lock-in socket. Filament volts (dc), 1.4; amperes, 0.05. For electrical characteristics and typical operation, refer to glass-octal type 1A5-GT.

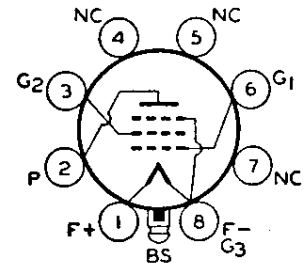

1LA6

PENTAGRID CONVERTER

Glass lock-in type used in battery-operated receivers. Outline 12, OUTLINES SECTION. Tube requires lock-in socket. Filament volts (dc), 1.4; amperes, 0.05. Typical operation as converter is the same as for type 1A7-GT except that the maximum grid-No.2 volts is 65, the maximum total cathode ma. is 4.0, the plate resistance is 0.75 megohm, and the conversion transconductance for a grid-No.4 (control-grid) bias of -3 volts is 10 μ mhos.

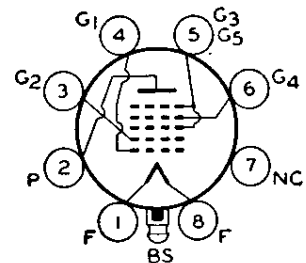

1LB4

POWER PENTODE

Glass lock-in type used in output stage of battery-operated receivers. Outline 12, OUTLINES SECTION. Tube requires lock-in socket. Filament volts (dc), 1.4; amperes, 0.05. For electrical characteristics, refer to pentode unit of glass-octal type 1D8-GT.

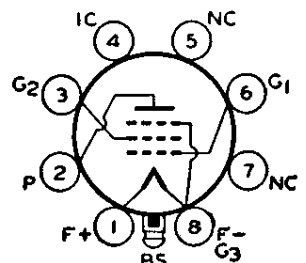

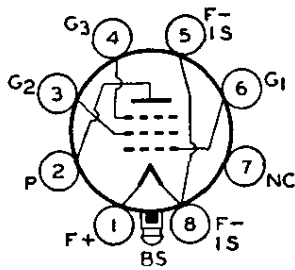

SHARP-CUTOFF PENTODE

Glass lock-in type used as rf or if amplifier in battery-operated receivers. Outline 12, OUTLINES SECTION. Tube requires lock-in socket. Filament volts (dc), 1.4; amperes, 0.05. Typical operation as class A₁ amplifier: plate volts, 90 (110 max); grid-No.2 (screen) volts, 45 max; grid-No.1 volts, 0; plate resistance (approx.), 1.5 megohms; transconductance, 775 μmhos; plate ma., 1.15; grid-No.2 ma., 0.3.

1LC5

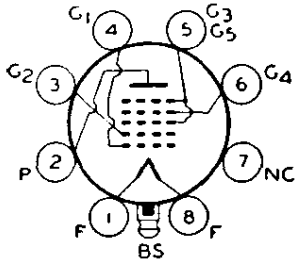

PENTAGRID CONVERTER

Glass lock-in type used in battery-operated receivers. Outline 12, OUTLINES SECTION. Tube requires lock-in socket. Filament volts (dc), 1.4; amperes, 0.05. Typical operation as converter: plate volts, 90 (110 max); grids-No.3-and-No.5 volts, 35 (45 max); grid-No.2 volts, 45; grid-No.1 volts, 0; plate resistance, 0.65 megohm; plate ma., 0.75; grids-No.3-and-No.5 ma., 0.70; grid-No.2 ma., 1.4; total cathode ma., 2.9; conversion transconductance (zero bias), 275 μmhos.

1LC6

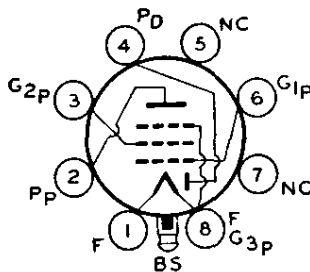

DIODE—SHARP-CUTOFF PENTODE

Glass lock-in type used as combined detector and af voltage amplifier in battery-operated receivers. Outline 12, OUTLINES SECTION. Tube requires lock-in socket. Filament volts (dc), 1.4; amperes, 0.05. Characteristics of pentode unit: plate volts, 90 (110 max); grid-No.2 volts, 45; grid-No.1 volts, 0; plate ma., 0.6; grid-No.2 ma., 0.1; plate resistance, 0.75 megohm; transconductance, 575 μmhos.

1LD5

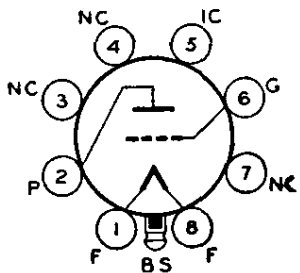

MEDIUM-MU TRIODE

Glass lock-in type used as detector or voltage amplifier in battery-operated receivers. Outline 12, OUTLINES SECTION. Tube requires lock-in socket. Filament volts (dc), 1.4; amperes, 0.05. Typical operation as class A₁ amplifier: plate volts, 90 (110 max); grid volts, -3; plate ma., 1.4; plate resistance, 19000 ohms; transconductance, 760 μmhos; amplification factor, 14.5.

1LE3

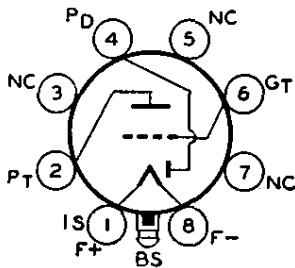

DIODE—MEDIUM-MU TRIODE

Glass lock-in type used as combined detector and amplifier in battery-operated receivers. Outline 12, OUTLINES SECTION. Tube requires lock-in socket. Filament volts (dc), 1.4; amperes, 0.05. For electrical characteristics, refer to glass-octal type 1H5-GT.

1LH4

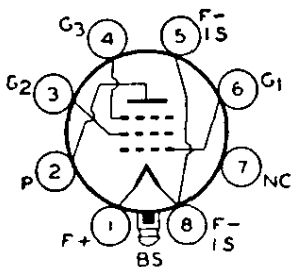

SHARP-CUTOFF PENTODE

Glass lock-in type used as rf or if amplifier in battery-operated receivers. Outline 12, OUTLINES SECTION. Tube requires lock-in socket. Filament volts (dc), 1.4; amperes, 0.05. Typical operation as class A₁ amplifier: plate and grid-No.2 (screen) volts, 90 (110 max); grid-No.1 volts, 0; plate ma., 1.6; grid-No.2 ma., 0.35; plate resistance (approx.), 1.1 megohms; transconductance, 800 μmhos.

1LN5

1N5-GT

SHARP-CUTOFF PENTODE

Glass octal type used as rf or if amplifier in battery-operated receivers. Outline 18, OUTLINES SECTION. Tube requires octal socket and may be mounted in any position. When used

in avc circuits, the 1N5-GT should be only partially controlled to avoid excessive reduction in receiver sensitivity with large signal input.

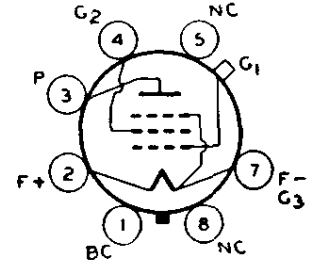

FILAMENT VOLTAGE (DC).....	1.4	volts
FILAMENT CURRENT.....	0.05	ampere
DIRECT INTERELECTRODE CAPACITANCES:*		
Grid No.1 to Plate.....	0.007 max	μμf
Input.....	3	μμf
Output.....	10	μμf

*With shield connected to negative filament terminal.

Typical Operation:

CLASS A₁ AMPLIFIER

Plate Voltage (110 volts max).....	90	volts
Grid-No.2 (Screen) Voltage (110 volts max).....	90	volts
Grid-No.1 Voltage.....	0	volts
Plate Resistance (Approx.).....	1.5	megohms
Transconductance.....	750	μmhos
Transconductance at -4 volts bias (Approx.).....	5	μmhos
Plate Current.....	1.2	ma
Grid-No.2 Current.....	0.3	ma

DIODE—POWER PENTODE

Glass octal type used as combined detector and power output tube in battery-operated receivers. Filament volts (dc), 1.4; amperes, 0.05. Typical operation of pentode unit as class A₁ amplifier: plate and grid-No.2 (screen) volts, 90 (110 max); grid-No.1 volts, -4.5; plate ma., 3.1; grid-No.2 ma. (zero-signal), 0.6; plate resistance (approx.), 0.3 megohm; transconductance, 800 μmhos; load resistance, 25000 ohms; output watts, 0.1. This is a DISCONTINUED type listed for reference only.

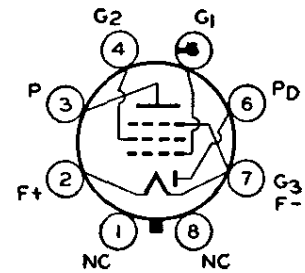

1N6-G

REMOTE-CUTOFF PENTODE

Glass octal type used as rf or if amplifier in battery-operated receivers. Outline 18, OUTLINES SECTION. Tube requires octal socket. Filament volts (dc), 1.4; amperes, 0.05. Typical operation as class A₁ amplifier: plate volts, 90 (110 max); grid-No.2 (screen) volts, 90 (110 max); grid-No.1 volts, 0; plate resistance (approx.), 0.8 megohm; transconductance, 750 μmhos; transconductance (approx.) with -12 volts on grid-No.1, 10 μmhos; plate ma., 2.3; grid-No.2 ma., 0.7.

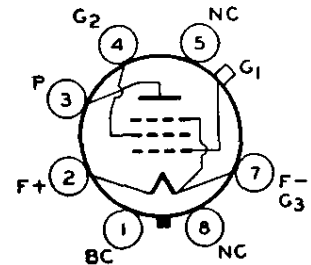

1P5-GT

BEAM POWER AMPLIFIER

Glass octal type used in the output stage of battery-operated receivers. Outline 17, OUTLINES SECTION. Tube requires octal socket. Filament volts (dc), 1.4; amperes, 0.1. For electrical characteristics and ratings, refer to type 3Q5-GT with parallel filament arrangement.

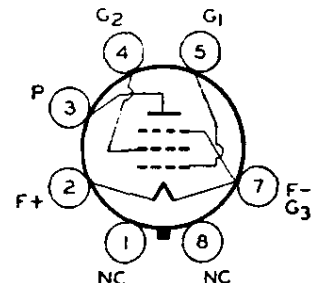

1Q5-GT

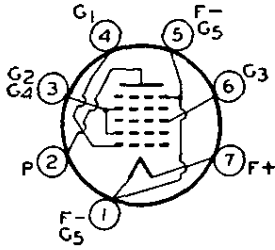

PENTAGRID CONVERTER

1R5

Miniature type used in lightweight, portable, compact, battery-operated receivers. Outline 10, OUTLINES SECTION. Tube requires miniature seven-contact socket and may be mounted in

any position. For general discussion of pentagrid types, see Frequency Conversion in ELECTRON TUBE APPLICATIONS SECTION. For filament considerations, refer to type 1U4.

FILAMENT VOLTAGE (DC).....	1.4	volts
FILAMENT CURRENT.....	0.05	ampere
DIRECT INTERELECTRODE CAPACITANCES (No external shield):		
Grid No.3 to All Other Electrodes (RF Input).....	7.0	$\mu\mu\text{f}$
Plate to All Other Electrodes (Mixer Output).....	7.5	$\mu\mu\text{f}$
Grid No.1 to All Other Electrodes (Osc. Input).....	3.8	$\mu\mu\text{f}$
Grid No.3 to Plate.....	0.4 max	$\mu\mu\text{f}$
Grid No.3 to Grid No.1.....	0.2 max	$\mu\mu\text{f}$
Grid No.1 to Plate.....	0.1 max	$\mu\mu\text{f}$

Maximum Ratings:

CONVERTER SERVICE

PLATE VOLTAGE.....	90 max	volts
GRIDS-NO.2-AND-NO.4 (SCREEN) VOLTAGE.....	67.5 max	volts
GRIDS-NO.2-AND-NO.4 SUPPLY VOLTAGE.....	90 max	volts
GRID-NO.3 (CONTROL-GRID) BIAS VOLTAGE.....	0 min	volts
TOTAL ZERO-SIGNAL CATHODE CURRENT.....	5.5 max	ma

Typical Operation:

Plate Voltage.....	45	67.5	90	90	volts
Grids-No.2-and-No.4 Voltage.....	45	67.5	45	67.5	volts
Grid-No.3 Voltage.....	0	0	0	0	volts
Grid-No.1 Resistor.....	0.1	0.1	0.1	0.1	megohm
Plate Resistance (Approx.).....	0.6	0.5	0.8	0.6	megohm
Conversion Transconductance.....	235	280	250	300	μmhos
Grid-No.3 Bias for conversion transconductance of approx. 5 μmhos	-9	-14	-9	-14	volts
Plate Current.....	0.7	1.4	0.8	1.6	ma
Grids-No.2-and-No.4 Current.....	1.9	3.2	1.9	3.2	ma
Grid-No.1 Current.....	0.15	0.25	0.15	0.25	ma
Total Cathode Current.....	2.75	5	2.75	5	ma

NOTE: The transconductance between grid No.1 and grids No.2 and No.4 tied to plate (not oscillating) is approximately 1400 μmhos under the following conditions: grids No.1 and No.3 at 0 volts; grids No.2 and No.4 and plate at 67.5 volts.

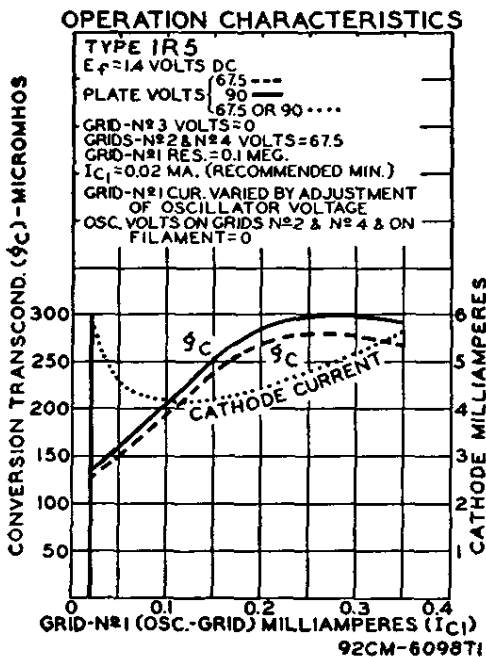

OPERATION CHARACTERISTICS

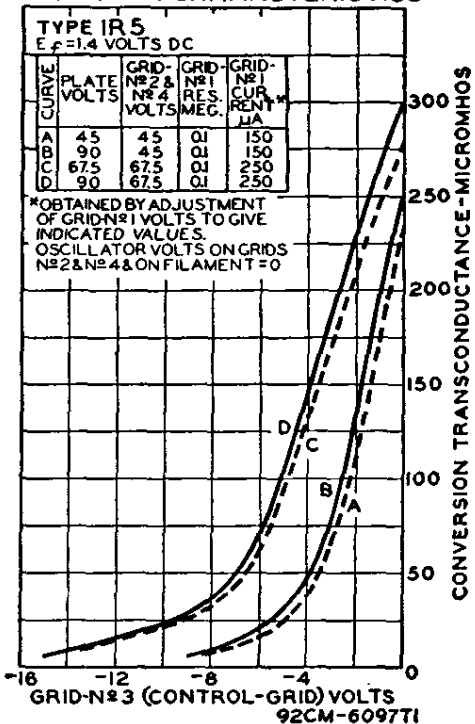

POWER PENTODE

1S4

Miniature type used in output stage of lightweight, compact, portable, battery-operated equipment. Types 1S4 and 3S4 are identical except for filament arrangement. Out-

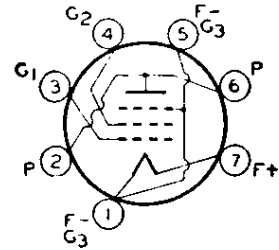

line 10, OUTLINES SECTION. Type 1S4 requires miniature seven-contact socket and may be mounted in any position. For ratings, typical operation, and curves, refer to type 3S4 with parallel filament arrangement. For filament considerations, refer to type 1U4 and ELECTRON TUBE INSTALLATION SECTION. Filament volts (dc), 1.4; amperes, 0.1.

DIODE—

SHARP-CUTOFF PENTODE

1S5

Miniature type used in lightweight, compact, portable, battery-operated receivers as combined detector and af voltage amplifier. Outline 10,

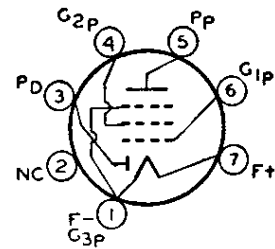

OUTLINES SECTION. Filament volts (dc), 1.4; amperes, 0.05. Tube requires miniature seven-contact socket and may be mounted in any position. For electrical characteristics, curves, and application, refer to type 1U5.

REMOTE-CUTOFF PENTODE

1T4

Miniature type used in lightweight, compact, portable, battery-operated receivers as rf or if amplifier. Because of internal shielding feature, an external bulb shield is not needed,

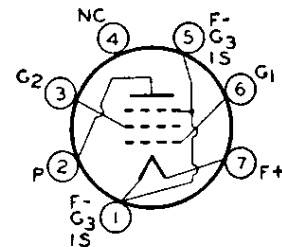

but socket shielding is essential if minimum grid-plate capacitance is to be obtained. Outline 10, OUTLINES SECTION. Tube requires miniature seven-contact socket and may be mounted in any position. For filament considerations, refer to type 1U4.

FILAMENT VOLTAGE (DC).....	1.4	volts
FILAMENT CURRENT.....	0.05	ampere
DIRECT INTERELECTRODE CAPACITANCES:*		
Grid No.1 to Plate.....	0.01 max	μf
Input.....	3.6	μf
Output.....	7.5	μf

* With close-fitting shield connected to negative filament terminal.

Maximum Ratings:

CLASS A₁ AMPLIFIER

PLATE VOLTAGE.....	90 max	volts
GRID-NO.2 (SCREEN) VOLTAGE.....	67.5 max	volts
GRID-NO.2 SUPPLY VOLTAGE.....	90 max	volts
GRID-NO.1 (CONTROL-GRID) VOLTAGE.....	0 min	volts
TOTAL CATHODE CURRENT.....	6.0 max	ma

Typical Operation:

Plate Voltage.....	45	67.5	90	90	volts
Grid-No.2 Voltage.....	45	67.5	45	67.5	volts
Grid-No.1 Voltage.....	0	0	0	0	volts
Plate Resistance (Approx.).....	0.35	0.25	0.8	0.5	megohm
Transconductance.....	700	875	750	900	μmhos
Grid Bias for transconductance of 10 μmhos.....	-10	-16	-10	-16	volts
Plate Current.....	1.7	3.4	1.8	3.5	ma
Grid-No.2 Current.....	0.7	1.5	0.65	1.4	ma

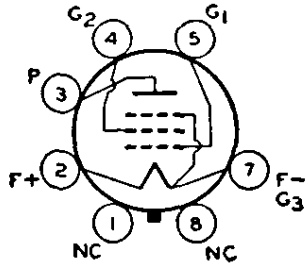
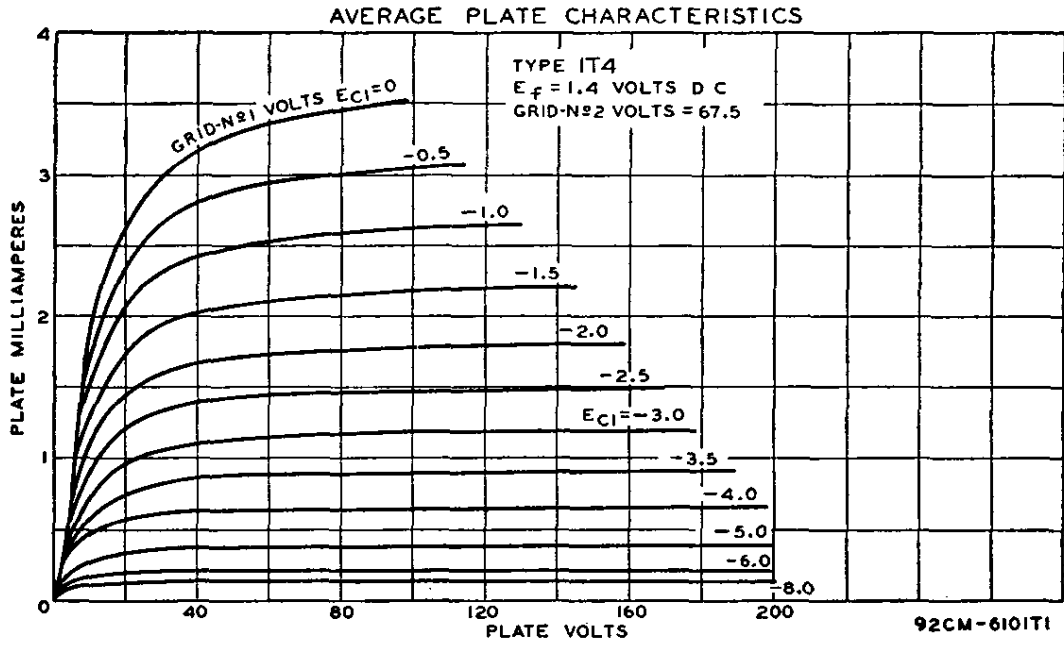

BEAM POWER AMPLIFIER

Glass octal type used in output stage of battery-operated receivers. Outline 17, OUTLINES SECTION. Tube requires octal socket. Filament volts (dc), 1.4; amperes, 0.05. For filament considerations, refer to type 1U4. Typical operation as class A₁ amplifier with fixed bias: plate and grid-No.2 (screen) volts, 90 (110 max); grid-No.1 volts, -6; peak af grid-No.1 volts, 6; plate ma. (maximum or zero-signal),

1T5-GT

6.5; grid-No.2 ma. (zero-signal), 0.8; grid-No.2 ma. (maximum signal), 1.5; plate resistance, 0.25 meg-ohm; transconductance, 1150 μmhos; load resistance, 14000 ohms; total harmonic distortion, 7.5 per cent; output watts, 0.17.

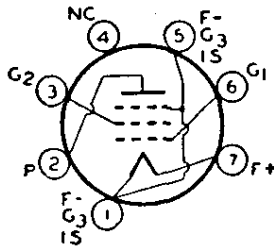

SHARP-CUTOFF PENTODE

Miniature type used as rf or if amplifier in stages not controlled by avc in lightweight, compact, portable, battery-operated equipment. Because the screen can be operated at the same

1U4

voltage as the plate, a voltage-dropping resistor is not needed. For typical operation as a resistance-coupled amplifier, refer to Chart 3, RESISTANCE-COUPLED AMPLIFIER SECTION.

FILAMENT VOLTAGE (DC)	1.4	volts
FILAMENT CURRENT	0.05	ampere
DIRECT INTERELECTRODE CAPACITANCES:*		
Grid No.1 to Plate	0.008 max	μf
Input	3.6	μf
Output	7.5	μf

* External shield connected to negative filament terminal.

Maximum Ratings:

CLASS A₁ AMPLIFIER

PLATE VOLTAGE	110 max	volts
GRID-NO.2 (SCREEN) VOLTAGE	110 max	volts
GRID-NO.1 (CONTROL-GRID) VOLTAGE:		
Negative Bias Value	30 max	volts
Positive Bias Value	0 max	volts
TOTAL CATHODE CURRENT	6.5 max	ma

Typical Operation:

Plate Voltage.....	90	volts
Grid-No.2 Voltage.....	90	volts
Grid-No.1 Voltage.....	0	volts
Plate Resistance (Approx.).....	1.5	megohms
Transconductance.....	900	μ mhos
Grid-No.1 Bias for transconductance of 10 μ mhos.....	-4.5	volts
Plate Current.....	1.6	ma
Grid-No.2 Current.....	0.45	ma

INSTALLATION AND APPLICATION

Type 1U4 requires a miniature seven-contact socket and may be mounted in any position. Outline 10, OUTLINES SECTION.

The filament power supply may be obtained from dry-cell batteries, from storage batteries, or from a power line. With dry-cell battery supply, the filament may be connected either directly across a battery rated at a terminal potential of 1.5 volts, or in series with the filaments of similar tubes across a power supply consisting of dry cells in series. In either case, the voltage across the filament should not exceed 1.6 volts.

With power-line or storage-battery supply, the filament may be operated in series with the filament of other tubes of the same filament-current rating. For such operation, design adjustments should be made so that, with tubes of rated characteristics, operating with all electrode voltages applied and on a normal line voltage of 117 volts or on a normal storage-battery voltage of 2.0 volts per cell (without a charger) or 2.2 volts per cell (with a charger), the voltage drop across the filament will be maintained within a range of 1.25 to 1.4 volts with a nominal center of 1.3 volts.

In order to meet the recommended conditions for operating filaments in series from dry-battery, storage-battery, or power-line sources, it may be necessary to use shunting resistors across the individual 1.4-volt sections of filament. Refer to ELECTRON TUBE INSTALLATION SECTION for additional filament considerations.

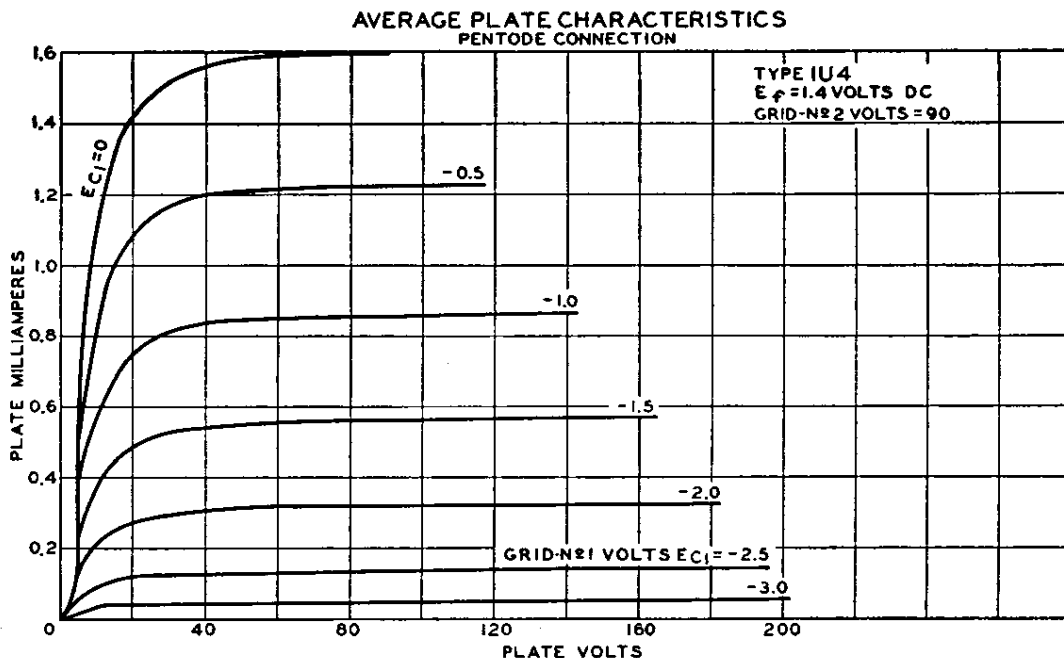

92CM-6669T

**DIODE—SHARP-CUTOFF
PENTODE**

1U5

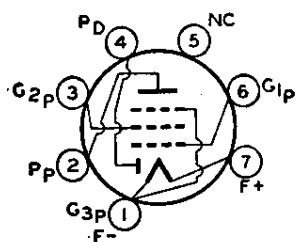

Miniature type used in light-weight, compact, portable, battery-operated receivers as combined detector and af voltage amplifier. Diode unit is located at negative end of filament

and is independent of the pentode except for the common filament. The 1U5 is similar to the 1S5 but utilizes an improved structure which greatly reduces any tendency toward microphonic effects. In addition, the diode unit is effectively shielded from the pentode unit to prevent "play-through". Outline 10, OUTLINES SECTION. Tube requires miniature seven-contact socket and may be mounted in any position. For typical operation as a resistance-coupled amplifier, refer to Chart 2, RESISTANCE-COUPLED AMPLIFIER SECTION. For filament consideration, refer to type 1U4.

FILAMENT VOLTAGE (DC).....	1.4	volts
FILAMENT CURRENT.....	0.05	ampere

Maximum Ratings: CLASS A₁ AMPLIFIER

PLATE VOLTAGE.....	90 <i>max</i>	volts
GRID-NO.2 (SCREEN) VOLTAGE.....	90 <i>max</i>	volts
TOTAL CATHODE CURRENT.....	4.5 <i>max</i>	ma
GRID-NO.1 (CONTROL-GRID) VOLTAGE:		
Negative Bias Value.....	50 <i>max</i>	volts
Positive Bias Value.....	0 <i>max</i>	volts

Characteristics (Pentode Unit):

Plate Voltage.....	67.5	volts
Grid-No.2 Voltage.....	67.5	volts
Grid-No.1 Voltage.....	0	volts
Plate Resistance.....	0.6	megohm
Transconductance.....	625	μmhos
Plate Current.....	1.6	ma
Grid-No.2 Current.....	0.4	ma

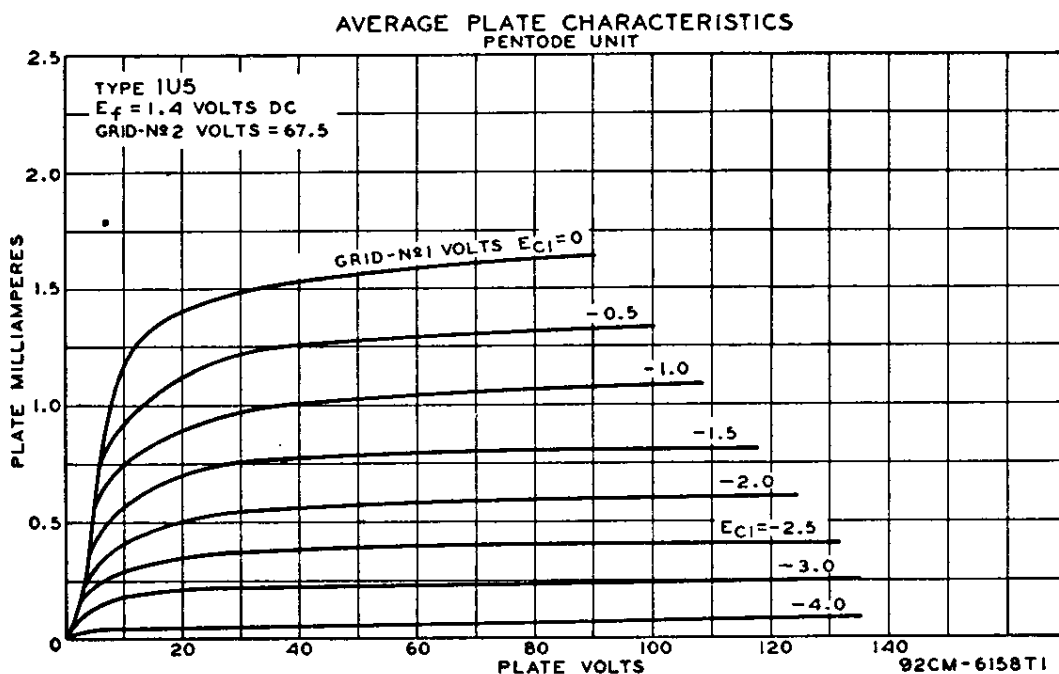

HALF-WAVE VACUUM RECTIFIER

1-v

Glass type used in ac/dc or automobile receivers. Outline 25, OUTLINES SECTION. Tube requires four-contact socket. For heater considerations, refer to type 6AT6. Heater volts (ac/dc), 6.3; amperes, 0.3. Maximum ratings as half-wave rectifier: peak inverse plate volts, 1000; peak plate ma., 270; peak heater-cathode volts, 500; dc output ma., 45.

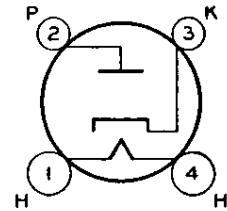

POWER TRIODE

2A3

Glass type used in output stage of radio receivers and amplifiers. As a class A₁ power amplifier, the 2A3 is usable either singly or in push-pull combination.

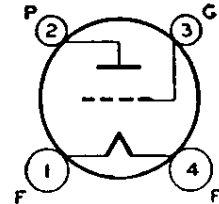

FILAMENT VOLTAGE (AC/DC).....	2.5	volts
FILAMENT CURRENT.....	2.5	amperes
DIRECT INTERELECTRODE CAPACITANCES (Approx.):		
Grid to Plate.....	16.5	μf
Grid to Filament.....	7.5	μf
Plate to Filament.....	5.5	μf

Maximum Ratings:		CLASS A₁ AMPLIFIER	
PLATE VOLTAGE.....	300 <i>max</i>	volts	
PLATE DISSIPATION.....	15 <i>max</i>	watts	

Typical Operation:			
Plate Voltage.....	250	volts	
Cathode Resistor.....	750	ohms	
Plate Current.....	60	ma	
Amplification Factor.....	4.2		
Plate Resistance.....	800	ohms	
Transconductance.....	5250	μmhos	
Load Resistance.....	2500	ohms	
Second Harmonic Distortion.....	5	per cent	
Power Output.....	3.5	watts	

Maximum Ratings:		PUSH-PULL CLASS AB₁ AMPLIFIER	
PLATE VOLTAGE.....	300 <i>max</i>	volts	
PLATE DISSIPATION.....	15 <i>max</i>	watts	

Typical Operation (Values Are For Two Tubes):		<i>Fixed Bias</i>	<i>Cathode Bias</i>	
Plate Voltage.....	300	300		volts
Grid Voltage*.....	-62	-		volts
Cathode-Bias Resistor.....	-	780		ohms
Peak AF Grid-to-Grid Voltage.....	124	156		volts
Zero-Signal Plate Current.....	80	80		ma
Maximum-Signal Plate Current.....	147	100		ma
Effective Load Resistance (Plate-to-plate).....	3000	5000		ohms
Total Harmonic Distortion.....	2.5	5.0		per cent
Power Output.....	15	10		watts

* Grid voltage referred to mid-point of ac-operated filament.

INSTALLATION AND APPLICATION

Type 2A3 requires a four-contact socket and should be mounted in a vertical position. Horizontal mounting is permissible if pins 1 and 4 are in a horizontal plane. Outline 34, OUTLINES SECTION. It is especially important that this tube, like other power-handling tubes, should be adequately ventilated.

The values recommended for push-pull operation are different from the conventional ones usually given on the basis of characteristics for a single tube. The values shown for Push-Pull Class AB₁ operation cover operation with fixed bias and with cathode bias, and have been determined on the basis of no grid current flow during the most positive swing of the input signal and of cancellation of second-harmonic distortion by virtue of the push-pull circuit. The cathode resistor

should preferably be shunted by a suitable filter network to minimize grid-bias variations produced by current surges in the cathode resistor.

When 2A3's are operated in push-pull, it is desirable to provide means for adjusting independently the bias on each tube. This requirement is a result of the very high transconductance of these tubes—5250 micromhos. This very high value makes the 2A3 somewhat critical as to grid-bias voltage, since a very small bias-voltage change produces a very large change in plate current. It is obvious, therefore, that the difference in plate current between two tubes may be sufficient to unbalance the system seriously. To avoid this possibility, simple methods of independent cathode-bias adjustment may be used, such as (1) input transformer with two independent secondary windings, or (2) filament transformer with two independent filament windings. With either of these methods, each tube can be biased separately so as to obtain circuit balance.

Any conventional type of *input coupling* may be used provided the resistance added to the grid circuit by this device is not too high. *Transformers or impedances are recommended.* When cathode bias is used, the dc resistance in the grid circuit should not exceed 0.5 megohm. With fixed bias, however, the dc resistance should not exceed 50000 ohms.

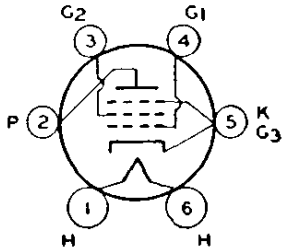

POWER PENTODE

Glass type used in output stage of ac-operated receivers. Outline 29, OUTLINES SECTION. Tube requires six-contact socket. Except for its heater rating (2.5 volts ac/dc; 1.75 amperes), the 2A5 has electrical characteristics identical with type 6F6. This type is used principally for renewal purposes.

2A5

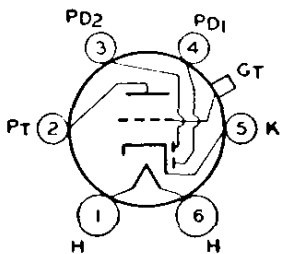

TWIN DIODE—HIGH-MU TRIODE

Glass type used in ac-operated receivers chiefly as a combined detector, amplifier, and avc tube. Outline 27, OUTLINES SECTION. Tube requires six-contact socket. Except for its heater rating (2.5 volts ac/dc; 0.8 ampere), and within its 250-volt maximum plate rating, the 2A6 has electrical characteristics identical with type 6SQ7. This type is used principally for renewal purposes.

2A6

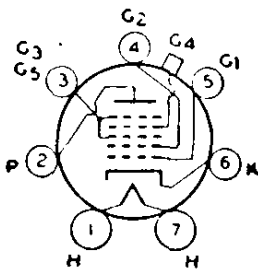

PENTAGRID CONVERTER

Glass type used in ac-operated receivers. Outline 27, OUTLINES SECTION. Tube requires small seven-contact (0.75-inch, pin-circle diameter) socket. Except for its heater rating (2.5 volts ac/dc; 0.8 ampere) and its interelectrode capacitances, the 2A7 has electrical characteristics identical with type 6A8. Complete shielding of this tube is generally necessary. This type is used principally for renewal purposes.

2A7

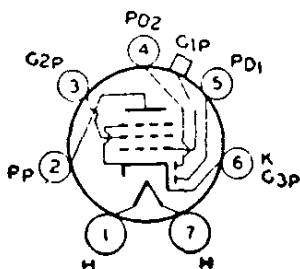

**TWIN DIODE—
REMOTE-CUTOFF PENTODE**

Glass type used as combined detector, avc tube, and amplifier. Outline 27, OUTLINES SECTION. Tube requires small seven-contact (0.75-inch, pin-circle diameter) socket. Except for its heater rating (2.5 volts ac/dc; 0.8 ampere) and its interelectrode capacitances, the 2B7 has electrical characteristics identical with type 6B8-G. This type is used principally for renewal purposes.

2B7

ELECTRON-RAY TUBE

2E5

Glass type used to indicate visually by means of a fluorescent target the effects of a change in a controlling voltage. It is used as a convenient means of indicating accurate radio receiver tuning. Outline 25, OUTLINES SECTION. Tube requires six-contact socket. Except for its heater rating (2.5 volts ac/dc; 0.8 ampere), the 2E5 has electrical characteristics identical with type 6E5. This type is used principally for renewal purposes.

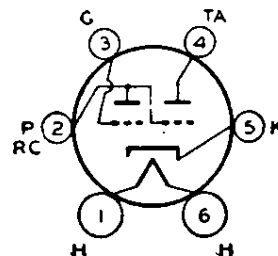

DIODE—TRIODE—PENTODE

3A8-GT

Glass octal type used as combined detector, af amplifier, and rf amplifier in battery-operated receivers. Filament has mid-tap so that tube may be used with either 1.4- or 2.8-volt dc filament supplies. Filament volts 1.4 (parallel), 2.8 (series); amperes 0.1 (parallel), 0.05 (series). Typical operation of triode unit as class A₁ amplifier: plate volts, 90 (110 max); grid volts, 0;

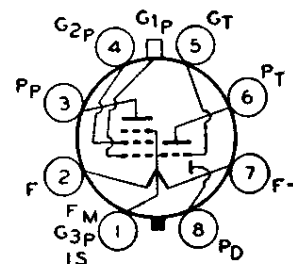

amplification factor, 65; plate resistance, 0.2 megohm; transconductance, 325 μmhos; plate ma., 0.2. Typical operation of pentode unit as class A₁ amplifier: plate volts, 90 (110 max); grid-No.2 volts, 90 (110 max); grid-No.1 volts, 0; plate resistance, 0.8 megohm; transconductance, 750 μmhos; plate ma., 1.5; grid-No.2 ma., 0.5. This type is used principally for renewal purposes.

BEAM POWER AMPLIFIER

3LF4

Glass lock-in type used in output stage of ac/dc/battery portable receivers. Outline 12, OUTLINES SECTION. Tube requires lock-in socket. Filament volts (dc) 1.4 (parallel), 2.8 (series); amperes 0.1 (parallel), 0.05 (series). For electrical characteristics, refer to glass-octal type 3Q5-GT.

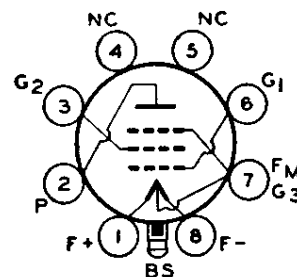

POWER PENTODE

3Q4

Miniature type used in output stage of lightweight, compact, portable, battery-operated equipment. Outline 10, OUTLINES SECTION. Except for terminal connections, types 3Q4 and

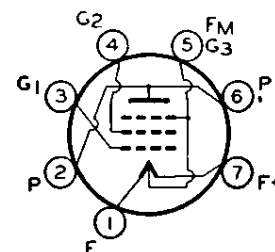

3V4 are identical. Refer to type 3V4 for ratings, typical operation, curves, and installation considerations.

BEAM POWER AMPLIFIER

3Q5-GT

Glass octal type used in output stage of ac/dc/battery portable receivers. Outline 17, OUTLINES SECTION. Tube requires octal socket and may be mounted in any position. For

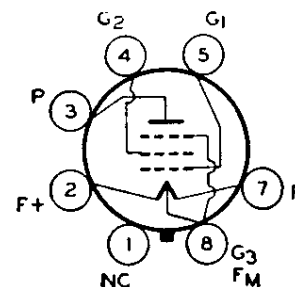

series filament arrangement, filament voltage is applied between pins 2 and 7. For parallel filament arrangement, filament voltage is applied between pin 8 and pins 2 and 7 connected together. For additional filament considerations, refer to type 3V4 and ELECTRON TUBE INSTALLATION SECTION.

RCA RECEIVING TUBE MANUAL

Filament Arrangement	<i>Series</i>	<i>Paralle</i>	
FILAMENT VOLTAGE (DC)	2.8	1.4	volts
FILAMENT CURRENT	0.05	0.1	ampere

Maximum Ratings: **CLASS A₁ AMPLIFIER**

	<i>Series</i>	<i>Paralle</i>	
PLATE VOLTAGE	110 <i>max</i>	110 <i>max</i>	volts
GRID-NO. 2 (SCREEN) VOLTAGE	110 <i>max</i>	110 <i>max</i>	volts
TOTAL ZERO-SIGNAL CATHODE CURRENT	6 <i>max</i>	12 <i>max</i>	ma

Typical Operation:

	<i>Series</i>		<i>Paralle</i>			
Plate Voltage	90	110	85	90	110	volts
Grid-No. 2 Voltage	90	110	85	90	110	volts
Grid-No. 1 Voltage*	-4.5	-6.6	-5	-4.5	-6.6	volts
Peak AF Grid-No. 1 Voltage	4.5	5.1	5	4.5	5.4	volts
Plate Current	8.0	8.5	7.0	9.5	10	ma
Grid-No. 2 Current (Approx.)	1.0	1.1	0.8	1.3	1.4	ma
Plate Resistance (Approx.)	0.08	0.11	0.07	0.09	0.1	megohm
Transconductance	2000	2000	1950	2200	2200	μmhos
Load Resistance	8000	8000	9000	8000	8000	ohms
Total Harmonic Distortion	8.5	8.5	5.5	6.0	6.0	per cent
Maximum-Signal Power Output	230	330	250	270	400	mw

* The grid-circuit resistance should not exceed 1.0 megohm for either cathode- or fixed-bias operation.

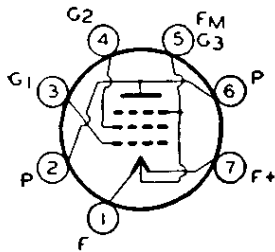

POWER PENTODE

Miniature type used in output stage of lightweight, compact, portable, battery-operated equipment. Outline 10, OUTLINES SECTION. Tube requires miniature seven-contact socket

3S4

and may be mounted in any position. Types 3S4 and 1S4 are identical except for filament arrangement. Type 3S4 features a filament mid-tap so that tube may be used either with a 1.4-volt battery supply or in series with other miniature tubes having 0.050-ampere filaments. For filament considerations, refer to type 3V4 and ELECTRON TUBE INSTALLATION SECTION.

Filament Arrangement	<i>Series</i>	<i>Paralle</i>	
FILAMENT VOLTAGE (DC)	2.8	1.4	volts
FILAMENT CURRENT	0.05	0.1	ampere

Maximum Ratings: **CLASS A₁ AMPLIFIER**

	<i>Series</i>		<i>Parallel</i>		
PLATE VOLTAGE	90	<i>max</i>	90	<i>max</i>	volts
GRID-NO. 2 (SCREEN) VOLTAGE	67.5	<i>max</i>	67.5	<i>max</i>	volts
TOTAL ZERO-SIGNAL CATHODE CURRENT	4.5#	<i>max</i>	9	<i>max</i>	ma
TOTAL MAXIMUM-SIGNAL CATHODE CURRENT	5.5#	<i>max</i>	11	<i>max</i>	ma

For each 1.4-volt filament section.

Typical Operation:

	<i>Series</i>		<i>Parallel</i>		
Plate Voltage	67.5	90	67.5	90	volts
Grid-No. 2 Voltage	67.5	67.5	67.5	67.5	volts
Grid-No. 1 (Control-Grid) Voltage	-7	-7	-7	-7	volts
Peak AF Grid-No. 1 Voltage	7	7	7	7	volts
Zero-Signal Plate Current	6.0	6.1	7.2	7.4	ma
Zero-Signal Grid-No. 2 Current	1.2	1.1	1.5	1.4	ma
Plate Resistance	0.1	0.1	0.1	0.1	megohm
Transconductance	1400	1425	1550	1575	μmhos
Load Resistance	5000	8000	5000	8000	ohms
Total Harmonic Distortion	12	13	10	12	per cent
Maximum-Signal Power Output	160	235	180	270	mw

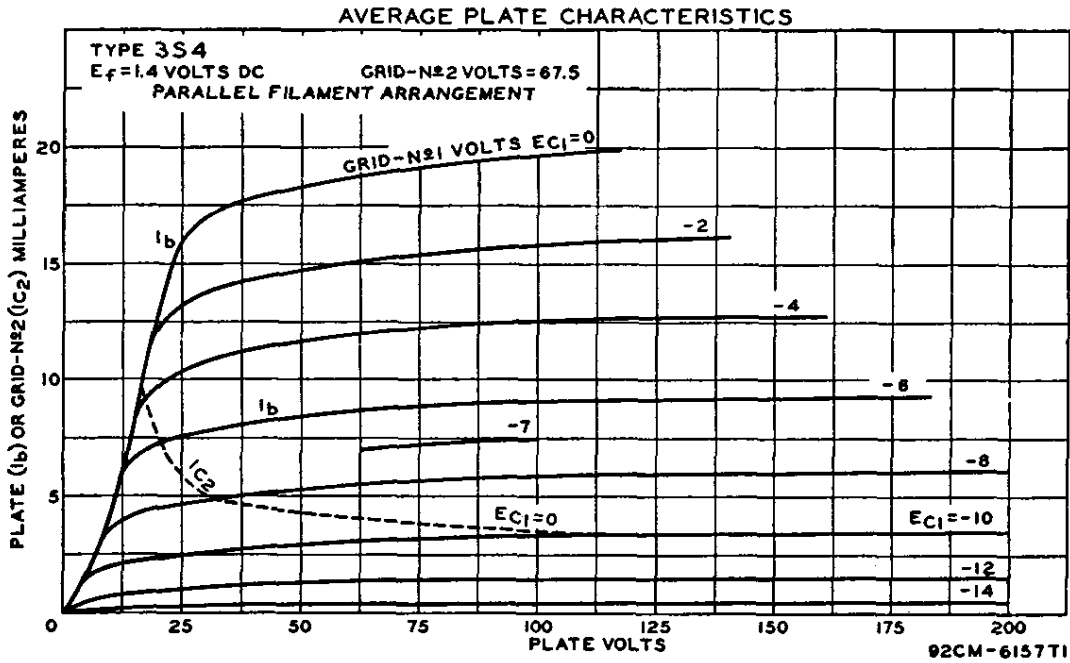

3V4

POWER PENTODE

Miniature type used in output stage of lightweight, compact, portable, battery-operated equipment. Except for terminal connections, types 3V4 and 3Q4 are identical. Both feature filament mid-tap so that tubes may be used either with a 1.4-volt battery supply or in series with other miniature tubes having 0.050-ampere filaments.

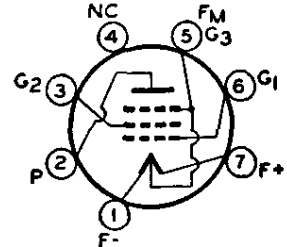

Filament Arrangement	<i>Series</i>	<i>Parallel</i>	
FILAMENT VOLTAGE (DC).....	2.8	1.4	volts
FILAMENT CURRENT.....	0.05	0.1	ampere
DIRECT INTERELECTRODE CAPACITANCES (Approx. With no external shield):			
Grid No. 1 to Plate.....	0.2		$\mu\mu\text{f}$
Input.....	5.5		$\mu\mu\text{f}$
Output.....	3.8		$\mu\mu\text{f}$

Maximum Ratings:

CLASS A₁ AMPLIFIER

	<i>Series</i>	<i>Parallel</i>	
PLATE VOLTAGE.....	90 <i>max</i>	90 <i>max</i>	volts
GRID-NO. 2 (SCREEN) VOLTAGE.....	90 <i>max</i>	90 <i>max</i>	volts
TOTAL ZERO-SIGNAL CATHODE CURRENT.....	6 # <i>max</i>	12 <i>max</i>	ma
TOTAL MAXIMUM-SIGNAL CATHODE CURRENT.....	6 # <i>max</i>	12 <i>max</i>	ma
# For each 1.4-volt filament section.			

Typical Operation:

	<i>Series</i>	<i>Parallel</i>		
Plate Voltage.....	90	85	90	volts
Grid-No. 2 Voltage.....	90	85	90	volts
Grid-No. 1 (Control-Grid) Voltage.....	-4.5	-5	-4.5	volts
Peak AF Grid-No. 1 Voltage.....	4.5	5	4.5	volts
Zero-Signal Plate Current.....	7.7	6.9	9.5	ma
Zero-Signal Grid-No. 2 Current.....	1.7	1.5	2.1	ma
Plate Resistance (Approx.).....	0.12	0.12	0.1	megohm
Transconductance.....	2000	1975	2150	μmhos
Load Resistance.....	10000	10000	10000	ohms
Total Harmonic Distortion.....	7	10	7	per cent
Maximum-Signal Power Output.....	240	250	270	mw

INSTALLATION AND APPLICATION

Type 3V4 requires miniature seven-contact socket and may be mounted in any position. Outline 10, OUTLINES SECTION.

The filament power supply may be obtained from dry-cell batteries, from storage batteries, or from a power line. With dry-cell battery supply, the filament may be connected either directly across a battery rated at a terminal potential of 1.5 volts, or in series with the filaments of similar tubes across a power supply consisting of dry cells in series. In any case, the voltage across each 1.4-volt section of filament should not exceed 1.6 volts.

With power-line or storage-battery supply, the filament may be operated in series with the filaments of other tubes of the same filament-current rating. For such operation, design adjustments should be made so that, with tubes of rated characteristics operating with all electrode voltages applied and on a normal line voltage of 117 volts or on a normal storage-battery voltage of 2.0 volts per cell (without a charger) or 2.2 volts per cell (with a charger), the voltage drop across each 1.4-volt section of filament will be maintained within a range of 1.25 to 1.4 volts with a nominal center of 1.3 volts.

For series operation of the sections, a shunting resistor must be connected across the section between the F- and Fm, the filament mid-tap, to bypass any cathode current in this section which is in excess of the rated maximum per section. When other tubes in a series-filament arrangement contribute to the filament current of the 3V4, an additional shunting resistor may be required across the entire filament (F- to F+).

For series filament arrangement, filament voltage is applied between No.1 and No.7. For parallel filament arrangement, filament voltage is applied between pin No.5 and pins No.1 and No.7 connected together. Refer to ELECTRON TUBE INSTALLATION SECTION for additional filament considerations.

In series filament arrangement, the grid-No.1 voltage is referred to F-. In parallel filament arrangement, the grid-No.1 voltage is referred to Fm, the filament mid-tap.

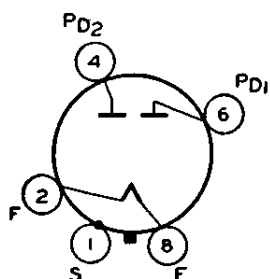
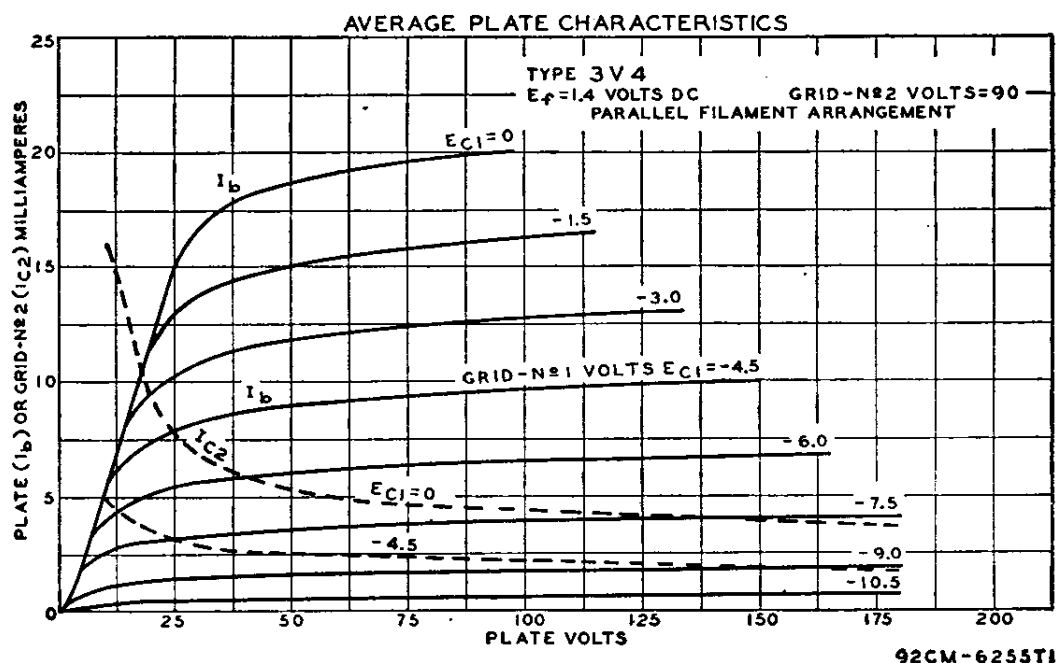

FULL-WAVE VACUUM RECTIFIER

Metal type used in power supply of radio equipment having large dc requirements. Outline 7, OUTLINES SECTION. Tube requires octal socket. Vertical tube mounting is preferred but horizontal mounting is permissible if pins 2 and 8 are in vertical plane. Filament volts (ac), 5.0; amperes, 2.0. Maximum ratings as a full-wave rectifier are the same as for type 5U4-G.

5T4

Typical Operation:
FULL-WAVE RECTIFIER

<i>Filter Input</i>	<i>Capacitor</i>	<i>Choke</i>	
AC Plate-to-Plate Supply Voltage (RMS).....	900	1100	volts
Filter-Input Capacitor.....	4	—	μ f
Total Effective Plate-Supply Impedance Per Plate†.....	150	—	ohms
Filter-Input Choke.....	—	10	henries
DC Output Current.....	225	225	ma
DC Output Voltage at Input to Filter (Approx.):			
At half-load current (112.5 ma.).....	530	465	volts
At full-load current (225 ma.).....	480	450	volts
Voltage Regulation (Approx.):			
Half-load to full-load current.....	50	15	volts

† When a filter-input capacitor larger than 40 μ f is used, it may be necessary to use more plate-supply impedance than the value shown in order to limit the peak plate current to the rated value.

5TP4

PROJECTION KINESCOPE

Projection-type kinescope used in television receivers having a reflective optical system. Features a metal-backed, white fluorescent screen having high brightness and contrast. High-

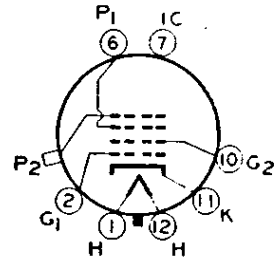

light brightness of the projected picture is about 15 foot-lamberts when the 5TP4 is operated at 27 kilovolts. Utilizes electrostatic focusing and magnetic deflection. Has solid deflection angle of 50° approx. Maximum bulb diameter is 5-1/8 inches; maximum overall length, 12-1/8 inches. Outline 37, OUTLINES SECTION. Provided with small-shell duodecal 7-pin base and a recessed small cavity cap.

HEATER VOLTAGE (AC/DC).....	6.3	volts
HEATER CURRENT.....	0.6	ampere
DIRECT INTERELECTRODE CAPACITANCES:		
Grid No. 1 to All Other Electrodes.....	7.5	μ f
Cathode to All Other Electrodes.....	5.0	μ f
External Conductive Coating to Anode No. 2.....	{ 500 max 100 min	{ μ f μ f

Maximum Ratings:

ANODE-NO. 2 Voltage.....	27000 max	volts
ANODE-NO. 1 Voltage.....	6000 max	volts
GRID-NO. 2 Voltage.....	350 max	volts
GRID-NO. 1 VOLTAGE:		
Negative bias value.....	150 max	volts
Positive bias value.....	0 max	volts
Positive peak value.....	2 max	volts
PEAK HEATER-CATHODE VOLTAGE:		
Heater negative with respect to cathode.....	175 max	volts
Heater positive with respect to cathode.....	10 max	volts

Typical Operation:

Anode-No. 2 Voltage*.....	27000	volts
Anode-No. 1 Voltage Range for Focus when Anode-No. 2 Current is 200 μ a.....	4320 to 5400	volts
Grid-No. 2 Voltage**.....	200	volts
Grid-No. 1 Voltage Range for Visual Cutoff ^o	-42 to -98	volts
Anode-No. 2 Current.....	200	μ a
Maximum Anode-No. 1 Current Range.....	-15 to +35	μ a
Grid-No. 2 Current Range.....	-15 to +15	μ a

Maximum Circuit Values:

Grid-No. 1-Circuit Resistance.....	1.5 max	megohms
------------------------------------	---------	---------

* Brilliance and definition decrease with decreasing anode voltages. In general, anode-No. 2 voltage should not be less than 20000 volts.

** Subject to variation of $\pm 40\%$ if grid-No. 1 voltage cutoff is desired at -70 volts.

^o Subject to variation of $\pm 40\%$ when grid-No. 2 voltage is maintained at 200 volts.

INSTALLATION AND APPLICATION

The base pins of the 5TP4 fit the duodecal socket mounting. In order to provide the maximum socket insulation for high-voltage pins 6 and 7, the socket contacts for pins 3, 4, 5, 8, and 9, should be removed. The socket should be made of high-grade, arc-resistant insulating material and should preferably be designed with baffles. The tube should be supported by a metal holder at the large end of the tube. The 5TP4 may be operated in any position.

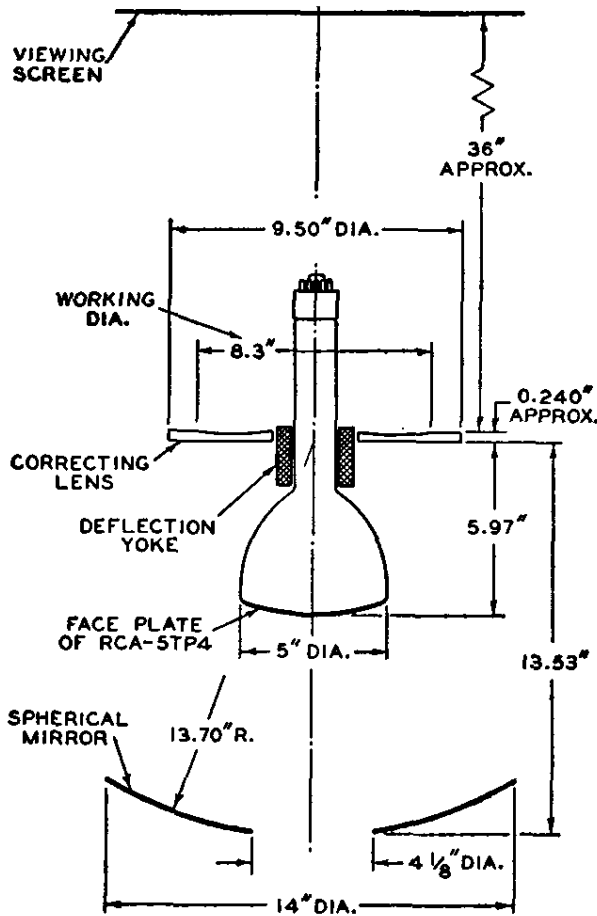

A typical reflective optical system for use with the 5TP4 is illustrated in the accompanying sketch. It consists of a spherical collecting mirror and a correcting lens located at the center of curvature of the mirror. The illustration also shows the location of the face plate of the 5TP4 and the location of the viewing screen with respect to the mirror and the correcting lens.

The neck external conductive coating must be grounded. Connection to the coating may be made by a flexible band around the base end of the coating, or by a soft brush contact attached to the bottom of the yoke. Unless the coating is grounded, it may assume the potential of anode No.2 and thus break down the yoke insulation.

The coating serves to prevent corona between the neck (which has an internal coating at anode-No.2 potential) and the yoke. Corona would act to damage the yoke insulation and to produce breakdown in the glass of the neck. It is important that the yoke insulation be adequate for operation of the yoke against the external grounded coating.

The bulb insulating (moisture-repellent) coating serves to prevent condensation of water vapor in a conductive film over the glass surface, and as a result, the erratic surface sparking which may be produced by such a film when a high-voltage gradient is present is eliminated. Care must be taken not to scratch the insulating coating, nor to wash or wipe it with any liquid likely to soften or dissolve lacquers.

Grid No. 2 is incorporated in the design of the 5TP4 to prevent interaction between the fields produced by grid No.1 and anode No.1. However, grid No.2 may also be used to compensate for the normal variation to be expected in the grid-No.1 voltage for cutoff in individual tubes. By adjusting the voltage applied to grid No.2 with due consideration to its maximum rated value, it is possible to fix the grid-No.1 bias at a desired value, and obtain almost the same anode-current characteristics for individual tubes having different cutoff voltages.

Since grid No.2 draws at most only a negligible leakage current, its voltage may be obtained from a potentiometer inserted in the anode-No.1 voltage divider. Adjusting grid-No.1 cutoff in this way not only makes grid drive more uniform, but also reduces variations in anode-No.1 current.

The high voltage at which these tubes are operated are very dangerous. Great care should be taken in the design of apparatus to prevent the operator from coming in contact with the high voltages. Precautions include the enclosing of high-potential terminals and the use of inter-locking switches to break the primary circuit of the power supply when access to the equipment is required.

To minimize the danger of these high voltages, it is recommended that the high-voltage supply for the 5TP4 be one in which the peak current even under short-circuit conditions is well below the value dangerous to life.

In the use of cathode-ray tubes, it should always be remembered that high voltages may appear at normally low-potential points in the circuit due to capacitor breakdown or to incorrect circuit connections. Therefore, before any part of the circuit is touched, the power-supply switch should be turned off and both terminals of any charged capacitors grounded.

Occasionally, after a tube has been transported, fine loose particles inside the tube may get on the anode-No.1 surface. When voltage is applied, there will be a momentary spark which fuses or removes the particles, so that no further sparking occurs. Such sparking causes no harm to the tube provided the maximum energy dissipated in the spark is kept small by use of a suitable high-voltage power supply as recommended above.

5U4-G

FULL-WAVE VACUUM RECTIFIER

Glass octal type used in power supply of radio equipment having high dc requirements. Outline 33, OUT-LINESSECTION. Tuberequires octal socket. Vertical mounting is preferred

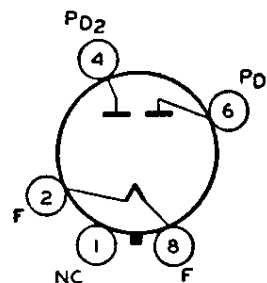

but horizontal mounting is permissible if pins 1 and 4 are in vertical plane. The coated filament is designed to operate from the ac line through a step-down transformer. The voltage at the filament terminals should be 5.0 volts under operating conditions at an average line voltage of 117 volts. It is especially important that this tube, like other power-handling tubes, should be adequately ventilated.

FILAMENT VOLTAGE (AC).....	5.0	volts
FILAMENT CURRENT.....	3.0	amperes

Maximum Ratings: FULL-WAVE RECTIFIER

PEAK INVERSE PLATE VOLTAGE.....	1550 max	volts
PEAK PLATE CURRENT.....	675 max	ma
DC OUTPUT CURRENT.....	225 max	ma

Typical Operation:

<i>Filter Input</i>	<i>Capacitor</i>	<i>Choke</i>	
AC Plate-to-Plate Supply Voltage (RMS).....	900	1100	volts
Filter-Input Capacitor.....	4	-	μ f
Total Effective Plate-Supply Impedance per Plate*.....	75	-	ohms
Min. Filter-Input Choke.....	-	3	henries
DC Output Current.....	225	225	ma
DC Output Voltage at Input to Filter (Approx.):			
At half-load current (112.5 ma.).....	515	450	volts
At full-load current (225 ma.).....	445	420	volts
Voltage Regulation (Approx.):			
Half-load to full-load current.....	70	30	volts

* When a filter-input capacitor larger than 40 μ f is used, it may be necessary to use more plate-supply impedance than the value shown in order to limit the peak plate current to the rated value.

OPERATION CHARACTERISTICS

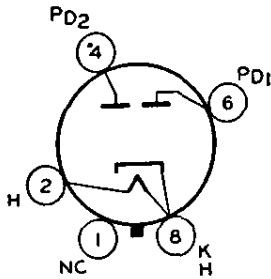
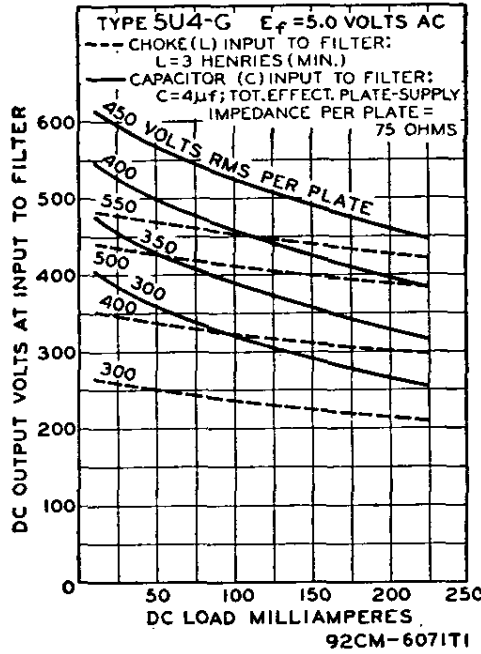

FULL-WAVE VACUUM RECTIFIER

Glass octal type used in power supply of radio equipment having high dc requirements. Outline 28, OUTLINES SECTION. Tube requires octal socket and may be mounted in any

5V4-G

position. The heater is designed to operate from the ac line through a step-down transformer. The voltage at the heater terminals should be 5.0 volts under operating conditions with a line voltage of 117 volts. It is especially important that this tube, like other power-handling tubes, should be adequately ventilated.

HEATER VOLTAGE (AC)	5.0	volts
HEATER CURRENT	2.0	amperes

Maximum Ratings: FULL-WAVE RECTIFIER

PEAK INVERSE PLATE VOLTAGE	1400 max	volts
PEAK PLATE CURRENT	525 max	ma
DC OUTPUT CURRENT	175 max	ma

Typical Operation:

	Capacitor	Choke	
AC Plate-to-Plate Supply Voltage (RMS)	750	1000	volts
Filter-Input Capacitor	8	—	μ f
Total Effective Plate-Supply Impedance per Plate*	100	—	ohms
Min. Filter-Input Choke	—	4	henries
DC Output Current	175	175	ma
DC Output Voltage at Input to Filter (Approx.):			
At half-load current (87.5 ma.)	455	425	volts
At full-load current (175 ma.)	415	415	volts
Voltage Regulation (Approx.):			
Half-load to full-load current	40	10	volts

* When a filter-input capacitor larger than 40 μ f is used, it may be necessary to use more plate-supply impedance than the value shown to limit the peak plate current to the rated value.

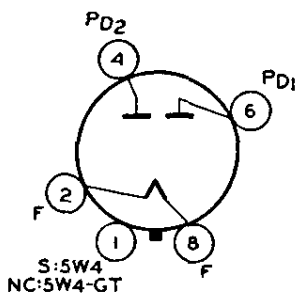

FULL-WAVE VACUUM RECTIFIER

Metal type 5W4 and glass-octal type 5W4-GT are used in power supply of radio equipment having low dc requirements. Outlines 6 and 20, respectively, OUTLINES SECTION. Both types require octal socket. Filament volts (ac), 5.0; amperes, 2.0. Maximum ratings: peak inverse plate volts, 1400 max; peak plate ma., 300 max; dc output ma., 100 max. The 5W4-GT is a DISCONTINUED type listed for reference only.

5W4
5W4-GT

5X4-G

FULL-WAVE VACUUM RECTIFIER

Glass octal type used in power supply of radio equipment having large dc requirements. Outline 33, OUTLINES SECTION. Filament volts, 5.0; amperes, 3.0. Except for basing arrangement, this type is identical with type 5U4-G.

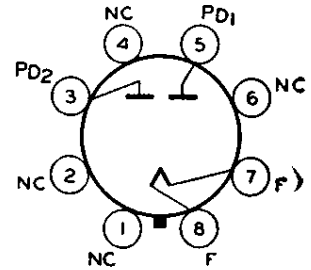

5Y3-GT

FULL-WAVE VACUUM RECTIFIER

Glass octal type used in power supply of radio equipment having moderate dc requirements. Outline 20, OUTLINES SECTION. Tube requires octal socket. Vertical tube mounting is preferred, but horizontal operation

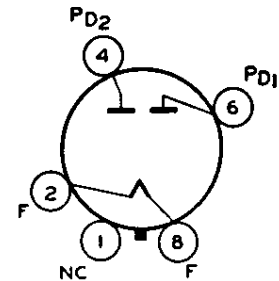

is permissible if pins 2 and 8 are in horizontal plane. It is especially important that this tube, like other power-handling tubes, should be adequately ventilated.

FILAMENT VOLTAGE (AC).....	5.0	volts
FILAMENT CURRENT.....	2.0	amperes

Maximum Ratings:

FULL-WAVE RECTIFIER

PEAK INVERSE PLATE VOLTAGE.....	1400 max	volts
PEAK PLATE CURRENT.....	375 max	ma
DC OUTPUT CURRENT.....	125 max	ma

Typical Operation:

Filter Input

	<i>Capacitor</i>	<i>Choke</i>	
AC Plate-to-Plate Supply Voltage (RMS).....	700	1000	volts
Filter-Input Capacitor.....	4	—	μ f
Total Effective Plate-Supply Impedance per Plate*.....	50	—	ohms
Min. Filter-Input Choke.....	—	5	henries
DC Output Current.....	125	125	ma
DC Output Voltage at Input to Filter (Approx.):			
At half-load current (62.5 ma.).....	390	410	volts
At full-load current (125 ma.).....	340	380	volts
Voltage Regulation (Approx.):			
Half-load to full-load current.....	50	30	volts

* When a filter-input capacitor larger than 40 μ f is used, it may be necessary to use more plate-supply impedance than the value shown to limit the peak plate current to the rated value.

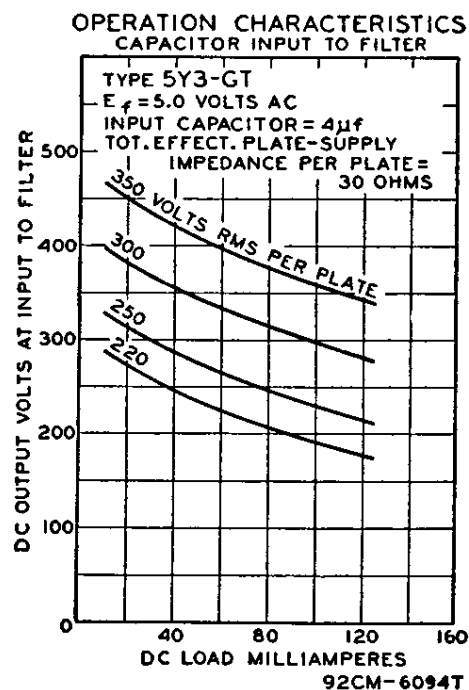
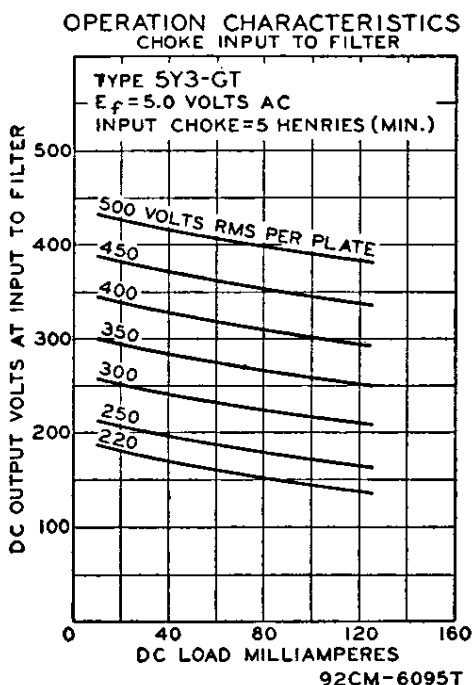

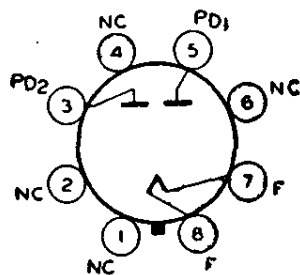

FULL-WAVE VACUUM RECTIFIER

Glass octal type used in power supply of radio equipment having moderate dc requirements. Outline 28, OUTLINES SECTION. Tube requires octal socket. Vertical tube mounting is preferred, but horizontal mounting is permissible if pins 2 and 7 are in horizontal plane. Filament volts (ac), 5.0; amperes, 2.0. For maximum ratings, typical operation, and curves, refer to type 5Y3-GT.

5Y4-G

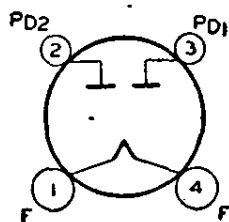

FULL-WAVE VACUUM RECTIFIER

Glass type used in power supply of radio equipment having large dc requirements. Outline 34, OUTLINES SECTION. Tube requires four-contact socket. Vertical mounting is preferred

5Z3

but horizontal mounting is permissible if pins 1 and 4 are in horizontal plane. Filament volts (ac), 5.0; amperes, 3.0. For maximum ratings, typical operation, and curves, refer to type 5U4-G.

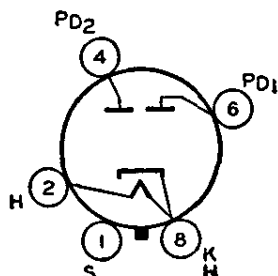

FULL-WAVE VACUUM RECTIFIER

Metal type used in power supply of radio equipment having moderate dc requirements. Outline 6, OUTLINES SECTION. Tube requires octal socket and may be mounted in any position. Heater volts (ac), 5.0; amperes, 2.0. Maximum ratings: peak inverse plate volts, 1400 max; peak plate ma. per plate, 375 max. Typical operation as full-wave rectifier with capacitor-input filter: ac plate-to-plate supply

5Z4

volts (RMS), 700; total effective plate-supply impedance per plate, 50 ohms; dc output ma., 125. Typical operation with choke-input filter: ac plate-to-plate supply volts, 1000; minimum filter-input choke, 5 henries; dc output ma., 125.

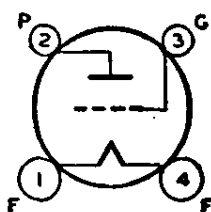

POWER TRIODE

Glass type used in output stage of radio receivers. Outline 34, OUTLINES SECTION. Tube requires four-contact socket. Except for filament rating (6.3 volts ac/dc; 1.0 ampere) and slightly lower power output, type 6A3 is identical electrically with type 2A3. This type is used principally for renewal purposes.

6A3

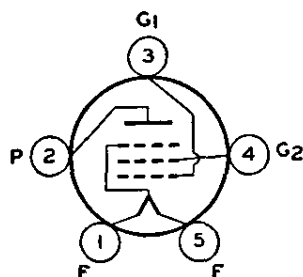

POWER PENTODE

Glass type used in output stage of automobile receivers. Outline 29, OUTLINES SECTION. Tube requires five-contact socket. Filament volts (ac/dc), 6.3; amperes, 0.3. Typical operation: plate and grid-No. 2 volts, 180 max; grid-No. 1 volts, -12; plate ma., 22; grid-No. 2 ma., 3.9; plate resistance, 45500 ohms approx.; transconductance, 2200 μmhos; load resistance, 8000 ohms; cathode-bias resistor, 465 ohms; output watts, 1.4. This type is used principally for renewal purposes.

6A4/LA

HIGH-MU TWIN POWER TRIODE

6A6

Glass type used in output stage of ac-operated receivers as a class B power amplifier or with units in parallel as a class A₁ amplifier to drive a 6A6 as class B amplifier. Outline 29, OUTLINES SECTION. Tube requires medium seven-contact (0.855-inch, pin-circle diameter) socket. Filament volts (ac/dc), 6.3; amperes, 0.8. This type is electrically identical with type 6N7. The 6A6 is used principally for renewal purposes.

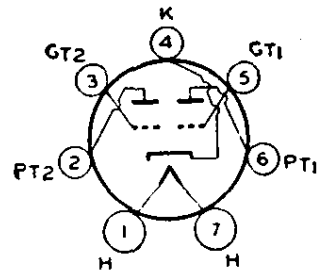

PENTAGRID CONVERTER

6A7

6A7S

Glass types used in superheterodyne circuits. Outline 27, OUTLINES SECTION. These types require the small seven-contact (0.75-inch, pin-circle diameter) socket. Except for interelectrode capacitances, the 6A7 is identical electrically with type 6A8. Type 6A7S, now DISCONTINUED, has an external shield connected to cathode. In general, its electrical characteristics are similar to those of the 6A7, but

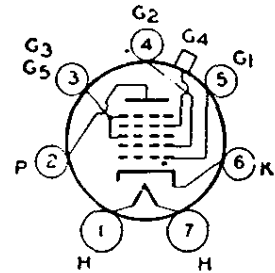

the two types are usually not directly interchangeable. Type 6A7 is used principally for renewal purposes.

6A8

6A8-G

6A8-GT

PENTAGRID CONVERTER

Metal type 6A8 and glass-octal types 6A8-G and 6A8-GT used in superheterodyne circuits. Type 6A8, Outline 4; type 6A8-G, Outline 26; type 6A8-GT, Outline 18, OUTLINES

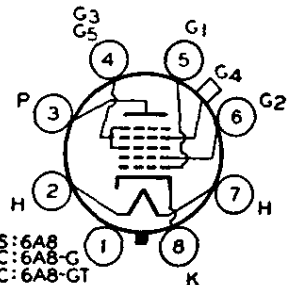

SECTION. All require octal socket. For general discussion of pentagrid types, see Frequency Conversion in ELECTRON TUBE APPLICATIONS SECTION. For heater and cathode considerations, refer to type 6AT6.

HEATER VOLTAGE (AC/DC).....	6.3	volts
HEATER CURRENT.....	0.8	ampere

Maximum Ratings:

CONVERTER SERVICE

PLATE VOLTAGE.....	300 max	volts
GRIDS-NO. 3-AND-NO. 5 (SCREEN) VOLTAGE.....	100 max	volts
GRIDS-NO. 3-AND-NO. 5 SUPPLY VOLTAGE.....	300 max	volts
GRID-NO. 2 (ANODE-GRID) VOLTAGE.....	200 max	volts
GRID-NO. 2 SUPPLY VOLTAGE.....	300 max	volts
GRID-NO. 4 (CONTROL-GRID) BIAS VOLTAGE.....	0 min	volts
PLATE DISSIPATION.....	1.0 max	watt
GRIDS-NO. 3-AND-NO. 5 DISSIPATION.....	0.3 max	watt
GRID-NO. 2 DISSIPATION.....	0.75 max	watt
TOTAL CATHODE CURRENT.....	14 max	ma
PEAK HEATER-CATHODE VOLTAGE:		
Heater negative with respect to cathode.....	90 max	volts
Heater positive with respect to cathode.....	90 max	volts

Typical Operation:

Plate Voltage.....	100	250	volts
Grids-No. 3-and-No. 5 Voltage.....	50	100	volts
Grid-No. 2 Voltage.....	100	-	volts
Grid-No. 2 Supply Voltage.....	-	250*	volts
Grid-No. 4 Voltage.....	-1.5	-3	volts
Grid-No. 1 (Oscillator-Grid) Resistor.....	50000	50000	ohms
Plate Resistance (Approx.).....	0.6	0.36	megohm
Conversion Transconductance.....	360	550	μmhos
Conversion Transconductance (Approx.) with control-grid bias of -20 volts.....	3	-	μmhos
Conversion Transconductance (Approx.) with control-grid bias of -35 volts.....	-	6	μmhos
Plate Current.....	1.1	3.5	ma
Grids-No. 3-and-No. 5 Current.....	1.3	2.7	ma
Grid-No. 2 Current.....	2	4	ma
Grid-No. 1 Current.....	0.25	0.4	ma
Total Cathode Current.....	4.6	10.6	ma

* Grid-No. 2 supply voltages in excess of 200 volts require use of 20000-ohm voltage-dropping resistor bypassed by 0.1-μf capacitor.

ELECTRON-RAY TUBE

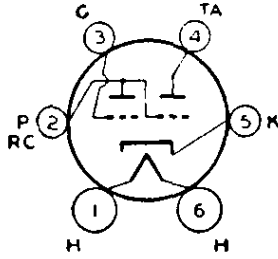

Glass type used to indicate visually by means of a fluorescent target the effects of a change in a controlling voltage. It is used as a convenient means of indicating accurate radio-receiver tuning. Outline 23, OUTLINES SECTION. Tube requires six-contact socket. For heater and cathode considerations, refer to type 6AT6. Heater volts (ac/dc), 6.3; amperes, 0.15. Ratings: plate-supply volts, 180 *max*; target volts 180 *max*, 125 *min*.

**6AB5/
6N5**

REMOTE-CUTOFF PENTODE

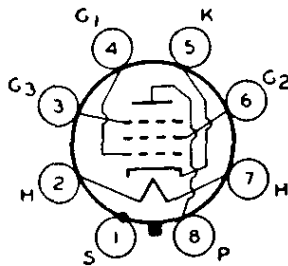

Metal type used in rf and if stages of picture amplifier of television receivers particularly those employing automatic-gain control. Outline 3, OUTLINES SECTION. Tube requires octal socket. Heater volts (ac/dc), 6.3; amperes, 0.45. Maximum ratings as class A₁ amplifier: plate and grid-No. 2 supply volts, 300 *max*; grid-No. 2 volts, 200 *max*; plate dissipation, 3.75 *max* watts; grid-No. 2 dissipation, 0.7 *max*

**6AB7/
1853**

watt. Typical operation: plate and grid-No.2 supply volts, 300; grid-No.3 volts, 0; grid-No.2 series resistor, 30000 ohms; grid-No.1 volts, -3; plate resistance (approx.), 0.7 megohm; transconductance, 5000 μ mhos; grid-No.1 volts for transconductance of 50 μ mhos, -15; plate ma., 12.5; grid-No.2 ma., 3.2.

HIGH-MU POWER TRIODE

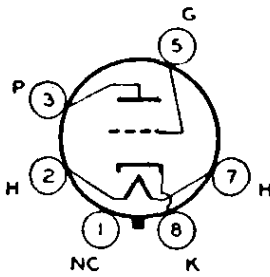

Glass octal type used in single-ended or push-pull audio-frequency power amplifiers of the direct-coupled type in which a driver tube develops positive grid bias for the 6AC5-GT output stage. Outline 17, OUTLINES SECTION. Tube requires octal socket. Heater volts (ac/dc), 6.3; amperes, 0.4. Maximum ratings: plate volts, 250 *max*; peak plate ma. (per tube), 110 *max*; average plate dissipation, 10 *max* watts. This type is used principally for renewal purposes.

6AC5-GT

SHARP-CUTOFF PENTODE

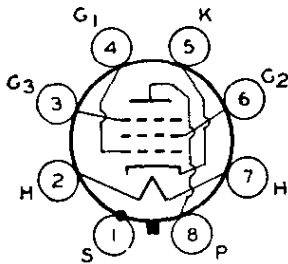

Metal type used in rf and if stages of picture amplifier and the first stages of the video amplifier of television receivers. It is also used as a mixer or oscillator tube in low-frequency applications. Outline 3, OUTLINES SECTION. Tube requires octal socket. When tube is used as a high-gain audio amplifier, heater should be operated from a battery source. For other heater considerations, refer to type 6AQ5.

**6AC7/
1852**

HEATER VOLTAGE (AC/DC)	6.3	volts
HEATER CURRENT	0.45	ampere
DIRECT INTERELECTRODE CAPACITANCES (Shell connected to cathode):		
Grid No.1 to Plate	0.015 <i>max</i>	μ f
Input	11	μ f
Output	5	μ f

Maximum Ratings:

CLASS A₁ AMPLIFIER

PLATE VOLTAGE	300 <i>max</i>	volts
GRID-NO.2 (SCREEN) VOLTAGE	150 <i>max</i>	volts
GRID-NO.2 SUPPLY VOLTAGE	300 <i>max</i>	volts
PLATE DISSIPATION	3 <i>max</i>	watts
GRID-NO.2 DISSIPATION	0.4 <i>max</i>	watt
PEAK HEATER-CATHODE VOLTAGE:		
Heater negative with respect to cathode	90 <i>max</i>	volts
Heater positive with respect to cathode	90 <i>max</i>	volts

Typical Operation:

	<i>Condition I*</i>	<i>Condition II**</i>	
Plate Voltage.....	300	300	volts
Grid-No. 3 Voltage.....	0	0	volts
Grid-No. 2 Supply Voltage.....	150	300#	volts
Grid-No. 2 Series Resistor.....	—	60000	ohms
Min. Cathode-Bias Resistor.....	160	160	ohms
Plate Resistance (Approx.).....	1	1	megohm
Transconductance.....	9000	9000	μ mhos
Plate Current.....	10	10	ma
Grid-No. 2 Current.....	2.5	2.5	ma

* With fixed grid-No.2 supply.

** With series grid-No. 2 resistor.

Grid-No.2 supply voltages in excess of 150 volts require use of a series dropping resistor to limit the voltage at grid No. 2 to 150 volts when the plate current is at its normal value of 10 milliamperes.

ELECTRON-RAY TUBE

Glass octal type used to indicate visually, by means of two shadows on the fluorescent target, the effects of changes in the controlling voltages. It is a twin-indicator type and is used as a convenient means of indicating accurate radio-receiver tuning. Heater volts (ac/dc), 6.3; amperes, 0.15. Maximum target volts, 150. This is a DISCONTINUED type listed for reference only.

6AD6-G

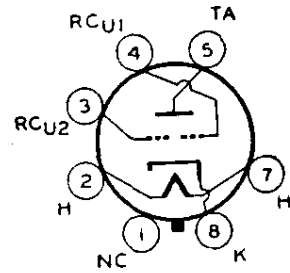

TRIODE—POWER PENTODE

Glass octal type used in a push-pull amplifier circuit in conjunction with type 6F6-G. Triode unit serves as phase inverter. Outline 28, OUTLINES SECTION. Tube requires octal socket. Heater volts (ac/dc), 6.3; amperes, 0.85. For typical operation of pentode unit as class A₁ or push-pull class AB₁ amplifier: plate volts, 375 max; grid-No. 2 volts, 285 max; plate

6AD7-G

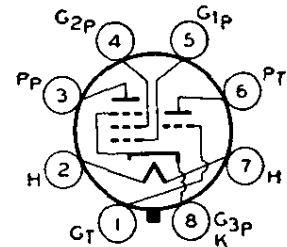

dissipation, 8.5 max watts; grid-No. 2 dissipation, 2.7 watts. Maximum ratings of triode unit as class A₁ amplifier: plate volts, 285 max; plate dissipation, 1.0 max watt.

LOW-MU TRIODE

Glass octal type used as class A₁ amplifier in ac/dc radio receivers. Outline 17, OUTLINES SECTION. Heater volts (ac/dc), 6.3; amperes, 0.3. Maximum ratings as class A₁ amplifier: plate volts, 300 max; plate dissipation, 2.5 max watts. This is a DISCONTINUED type listed for reference only.

6AE5-GT

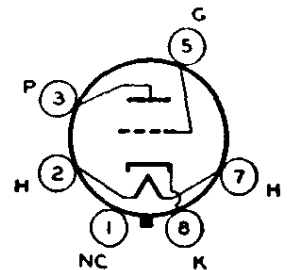

TWIN-PLATE CONTROL TUBE

Glass octal type used as a control tube for twin-indicator type electron-ray tubes. Outline 24, OUTLINES SECTION. Contains two triodes with different cutoff characteristics. If avc voltage is applied to the common control grid in suitable circuit, one triode section operates on weak signals while the other operates on strong signals. Heater voltage (ac/dc), 6.3; amperes, 0.15. This is a DISCONTINUED type listed for reference only.

6AE6-G

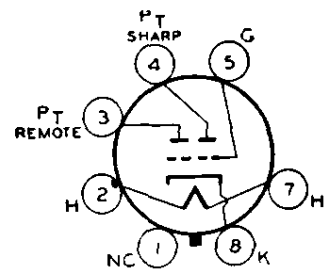

TWIN-INPUT TRIODE

Glass octal type used as a voltage amplifier or as a driver for two type 6AC5-GT tubes in dynamic-coupled, push-pull amplifiers. In the latter service, type 6AE7-GT replaces two tubes ordinarily required as drivers. Outline 17, OUTLINES SECTION. Heater volts (ac/dc), 6.3; amperes, 0.5. This is a DISCONTINUED type listed for reference only.

6AE7-GT

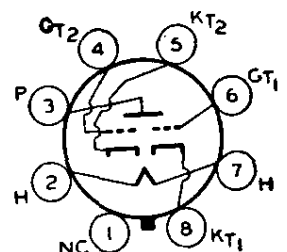

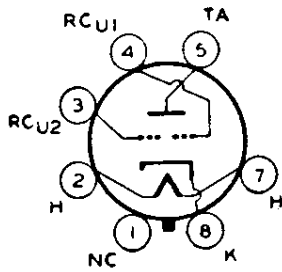

ELECTRON-RAY TUBE

6AF6-G

Glass octal type used to indicate visually, by means of two shadows on the fluorescent target, the effects of changes in the controlling voltages. It is a twin-indicator type and is used as a convenient means of indicating accurate radio-receiver tuning. Outline 9, OUTLINES SECTION. Tube requires octal socket. Heater volts (ac/dc), 6.3; amperes, 0.15. Ratings: target volts, 250 *max*, 125 *min*; ray-control-electrode supply volts, 250 *max*; peak heater-cathode volts, 90 *max*. Typical operation: target volts, 250; target ma., 2.2; series resistor, 1 megohm; ray-control electrode volts (approx. for 0° shadow angle), 160; ray-control electrode volts (approx. for 90° shadow angle), 0.

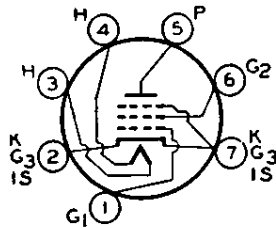

SHARP-CUTOFF PENTODE

6AG5

Miniature type used in compact radio equipment as an rf or if amplifier up to 400 megacycles. Outline 10, OUTLINES SECTION. Tube requires miniature seven-contact socket and may be mounted in any position. The two cathode leads facilitate isolation of the input and output circuits thus helping to minimize degeneration. For heater and cathode considerations, refer to type 6AT6.

HEATER VOLTAGE (AC/DC).....	6.3	volts
HEATER CURRENT.....	0.3	ampere
DIRECT INTERELECTRODE CAPACITANCES (No external shield):		
Grid No. 1 to Plate.....	0.025 <i>max</i>	$\mu\mu\text{f}$
Input.....	6.5	$\mu\mu\text{f}$
Output.....	1.8	$\mu\mu\text{f}$

CLASS A₁ AMPLIFIER

Maximum Ratings:		
PLATE VOLTAGE.....	300 <i>max</i>	volts
GRID-NO. 2 (SCREEN) VOLTAGE.....	150 <i>max</i>	volts
PLATE DISSIPATION.....	2 <i>max</i>	watts
GRID-NO. 2 DISSIPATION.....	0.5 <i>max</i>	watt
PEAK HEATER-CATHODE VOLTAGE:		
Heater negative with respect to cathode.....	90 <i>max</i>	volts
Heater positive with respect to cathode.....	90 <i>max</i>	volts

Typical Operation:

Plate Voltage.....	100	125	250	volts
Grid-No. 2 Voltage.....	100	125	150	volts
Cathode-Bias Resistor.....	100	100	200	ohms
Plate Resistance (Approx.).....	0.3	0.5	0.8	megohm
Transconductance.....	4750	5100	5000	μmhos
Grid-No.1 Bias for plate current of -10 μa	-5	-6	-8	volts
Plate Current.....	5.5	7.2	7	ma
Grid-No. 2 Current.....	1.6	2.1	2	ma

Maximum Ratings (Triode Connection):*

PLATE VOLTAGE.....	300 <i>max</i>	volts
PLATE DISSIPATION.....	2.5 <i>max</i>	watts

Typical Operation (Triode Connection):*

Plate Voltage.....	180	250	volts
Cathode-Bias Resistor.....	350	825	ohms
Plate Resistance.....	7900	11000	ohms
Amplification Factor.....	45	42	
Transconductance.....	5700	3800	μmhos
Plate Current.....	7.0	5.5	ma

* Grid No. 2 tied to plate.

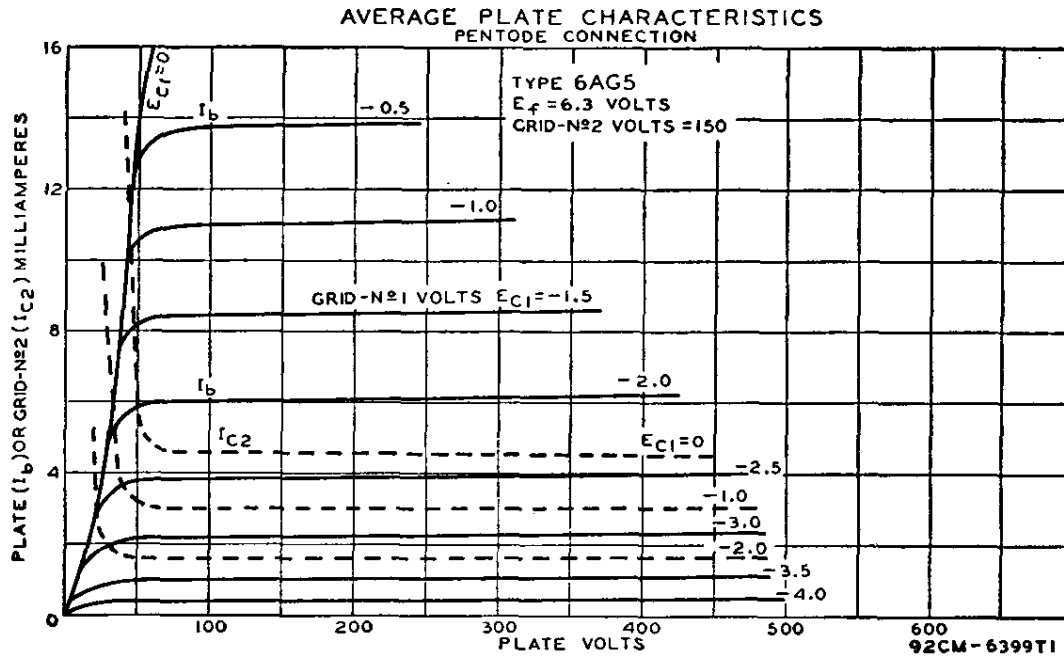

POWER PENTODE

6AG7

Metal type used in output stage of video amplifier of television receivers. Outline 6, OUTLINES SECTION. Tube requires octal socket. Heater volts (ac/dc), 6.3; amperes, 0.65. Maximum ratings as class A₁ video voltage amplifier: plate volts, 300 *max*; grid-No. 2 volts, 300 *max*; plate dissipation, 9.0 *max* watts; grid-No. 2 dissipation, 1.5 *max* watts. Typical operation as a class A₁ amplifier: plate volts, 300; grid-No. 2

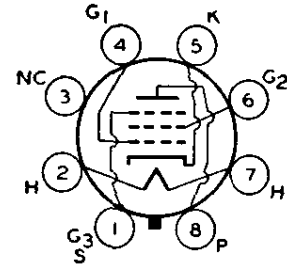

volts, 150; grid-No. 1 volts, -3; peak af grid-No. 1 volts, 3; zero-signal plate ma., 30; maximum-signal plate ma., 30.5; zero-signal grid-No. 2 ma., 7; maximum-signal grid-No. 2 ma., 9; plate resistance, 130000 ohms; transconductance, 11000 μ mhos; load resistance, 10000 ohms; total harmonic distortion, 7 per cent; maximum-signal output watts, 3.

POWER PENTODE

6AK6

Miniature type used in compact equipment as a power amplifier. Outline 10, OUTLINES SECTION. Tube requires miniature seven-contact socket and may be mounted in any position. For heater and cathode considerations, refer to type 6AT6.

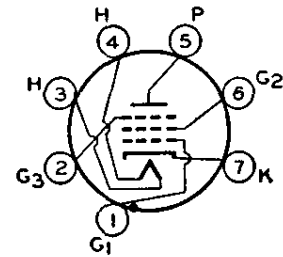

HEATER VOLTAGE (AC/DC).....	6.3	volts
HEATER CURRENT.....	0.15	ampere
DIRECT INTERELECTRODE CAPACITANCES (Approx. with no external shield):		
Grid No. 1 to Plate.....	0.12	μ f
Input.....	3.6	μ f
Output.....	4.2	μ f

CLASS A₁ AMPLIFIER

Maximum Ratings:

	<i>Triode# Connection</i>	<i>Pentode Connection</i>	
PLATE VOLTAGE.....	300 <i>max</i>	300 <i>max</i>	volts
GRID NO. 2 (SCREEN) VOLTAGE.....	-	300 <i>max</i>	volts
PLATE DISSIPATION.....	3.5 <i>max</i>	2.75 <i>max</i>	watts
GRID-NO. 2 DISSIPATION.....	-	0.75 <i>max</i>	watt
PEAK HEATER-CATHODE VOLTAGE:			
Heater negative with respect to cathode.....	90 <i>max</i>	90 <i>max</i>	volts
Heater positive with respect to cathode.....	90 <i>max</i>	90 <i>max</i>	volts

Typical Operation:

	<i>Triode# Connection</i>	<i>Pentode Connection</i>	
Plate Voltage.....	180	180	volts
Grid No. 3 (Suppressor).....	-	Connected to cathode at socket	
Grid-No. 2 Voltage.....	-	180	volts
Grid-No. 1 Voltage†.....	-12	-9	volts
Peak AF Grid-No. 1 Voltage.....	12	9	volts
Zero-Signal Plate Current.....	12	15	ma
Zero-Signal Grid-No. 2 Current.....	-	2.5	ma
Plate Resistance.....	0.0044	0.2	megohm
Amplification Factor.....	9.3	-	
Transconductance.....	2100	2300	μmhos
Load Resistance.....	12000	10000	ohms
Total Harmonic Distortion.....	5	10	per cent
Maximum-Signal Power Output.....	0.26	1.1	watts

† The dc resistance in the grid circuit under maximum rated conditions should not exceed 0.5 megohm for cathode-bias operation and 0.1 megohm for fixed-bias operation.

Grid No. 2 and grid No. 3 tied to plate.

**AVERAGE PLATE CHARACTERISTICS
PENTODE CONNECTION**

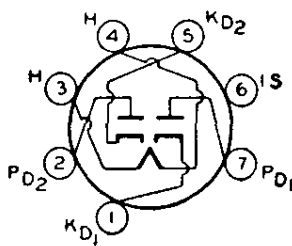
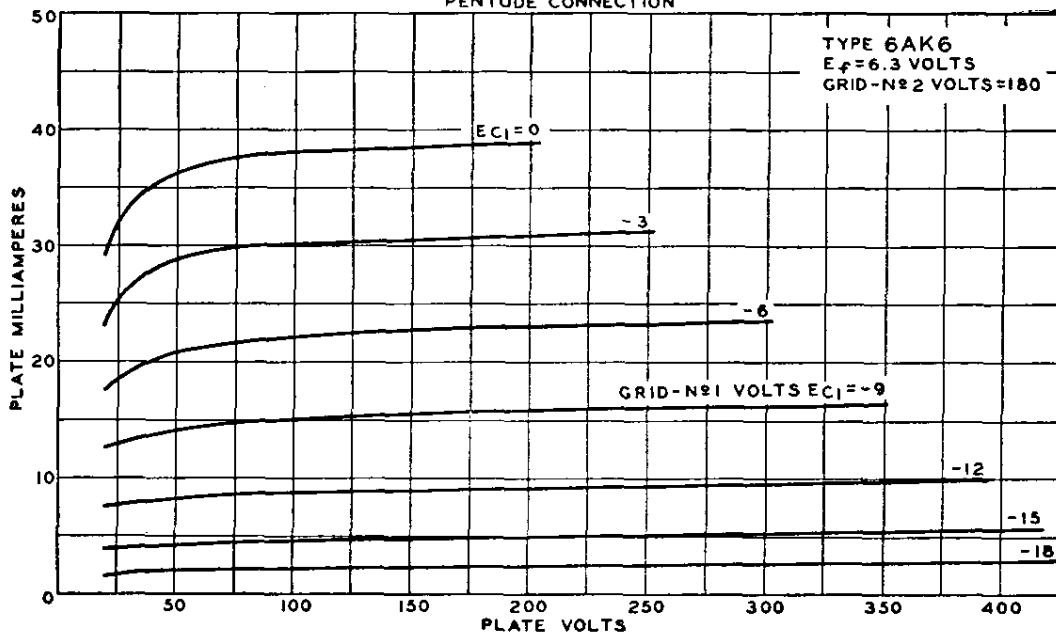

TWIN DIODE

Miniature, high-perveance type used as detector in FM and television circuits. It is especially useful as a ratio detector in ac-operated FM receivers. Each diode can be used in-

6AL5

dependently of the other or combined in parallel or full-wave arrangement. Resonant frequency of each unit is approximately 700 megacycles. Outline 8, OUTLINES SECTION. Tube requires miniature seven-contact socket and may be mounted in any position. For heater and cathode considerations, refer to type 6AT6.

HEATER VOLTAGE (AC/DC).....	6.3	volts
HEATER CURRENT.....	0.3	ampere
DIRECT INTERELECTRODE CAPACITANCES:		
Plate No. 1 to Cathode No. 1, Heater, and Internal Shield*.....	3.2	μμf
Plate No. 2 to Cathode No. 2, Heater, and Internal Shield**.....	3.2	μμf
Cathode No. 1 to Plate No. 1, Heater, and Internal Shield°.....	3.6	μμf
Cathode No. 2 to Plate No. 2, Heater, and Internal Shield°°.....	3.6	μμf
Plate No. 1 to Plate No. 2†.....	0.026 max	μμf

* With close-fitting external shield connected to Cathode No. 1.

** With close-fitting external shield connected to Cathode No. 2.

° With close-fitting external shield connected to Plate No. 1.

°° With close-fitting external shield connected to Plate No. 2.

† With close-fitting external shield connected to ground.

Maximum Ratings:
HALF-WAVE RECTIFIER

PEAK INVERSE PLATE VOLTAGE.....	420 <i>max</i>	volts
PEAK PLATE CURRENT PER PLATE.....	54 <i>max</i>	ma
DC OUTPUT CURRENT PER PLATE.....	9 <i>max</i>	ma
PEAK HEATER-CATHODE VOLTAGE.....	330 <i>max</i>	volts

Typical Operation:

AC Plate Voltage per Plate (RMS).....	150	volts
Min. Total Effective Plate-Supply Impedance.....	300	ohms
DC Output Current per Plate.....	9	ma

BEAM POWER AMPLIFIER

6AQ5

Miniature type used as output amplifier primarily in automobile receivers and in ac-operated receivers. Within its maximum ratings, the performance of the 6AQ5 is equivalent to that of larger types 6V6 and 6V6-GT.

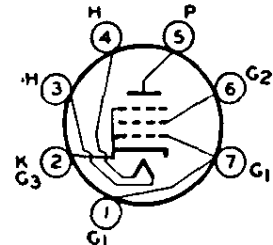

HEATER VOLTAGE (AC/DC).....	6.3	volts
HEATER CURRENT.....	0.45	ampere
DIRECT INTERELECTRODE CAPACITANCES (Approx. With external shield):...		
Grid No. 1 to Plate.....	0.17	$\mu\mu\text{f}$
Input.....	8.0	$\mu\mu\text{f}$
Output.....	11.0	$\mu\mu\text{f}$

CLASS A₁ AND CLASS AB₁ PUSH-PULL AMPLIFIER

Maximum Ratings:

PLATE VOLTAGE.....	250 <i>max</i>	volts
GRID-NO. 2 VOLTAGE.....	250 <i>max</i>	volts
PLATE DISSIPATION.....	12 <i>max</i>	watts
GRID-NO. 2 DISSIPATION.....	2 <i>max</i>	watts
PEAK HEATER-CATHODE VOLTAGE:		
Heater negative with respect to cathode.....	90 <i>max</i>	volts
Heater positive with respect to cathode.....	90 <i>max</i>	volts

Typical Operation:

Same as for type 6V6-GT within the limitations of the maximum ratings.

INSTALLATION AND APPLICATION

Type 6AQ5 requires a miniature seven-contact socket and may be mounted in any position. Outline 13, OUTLINES SECTION.

When the heater is operated on ac with a transformer, the winding of the transformer which supplies the heater circuit should operate the heater at the recommended value for full-load operating conditions at average line voltage. Under any condition of operation, the heater voltage should not be allowed to vary more than 10% from the rated value. When the 6AQ5 is used in automobile receivers, the heater terminals should be connected directly across the 6-volt battery.

Use of type 6AQ5 in a series string arrangement should be limited to tubes with the same heater-current rating. If it is necessary to use the 6AQ5 in series with tubes having different heater ratings, shunt resistors are required. Refer to ELECTRON TUBE INSTALLATION SECTION for additional heater considerations.

The cathode of the 6AQ5 should preferably be connected directly to the electrical mid-point of the heater circuit when the heater voltage is supplied from a transformer. When the 6AQ5 is operated in receivers employing a 6-volt storage battery for the heater supply, its cathode circuit is tied in either directly or through

bias resistors to the negative side of the dc plate supply which is furnished either by the dc power line or the ac line through a rectifier. Under any circumstances, the heater-cathode voltage should be kept within ratings. If the use of a large resistor is necessary in some circuit designs, it should be bypassed by a suitable filter network or objectionable hum may develop.

In all services, precautions should be taken to insure that the dissipation rating is not exceeded with expected line-voltage variations, especially in the cases of fixed-bias operation. When the push-pull connection is used, fixed-bias values up to 10% of each typical screen voltage can be used without increasing distortion.

The type of input coupling used in class A₁ and class B₁ service should not introduce too much resistance in the grid circuit. Transformer- or impedance-coupling devices are recommended. When the grid circuit has a resistance not higher than 0.05 megohm, fixed bias may be used; for higher values, cathode bias is required. With cathode bias, the grid circuit may have a resistance as high as, but not greater than, 0.5 megohm.

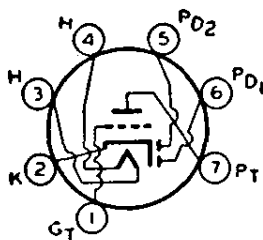
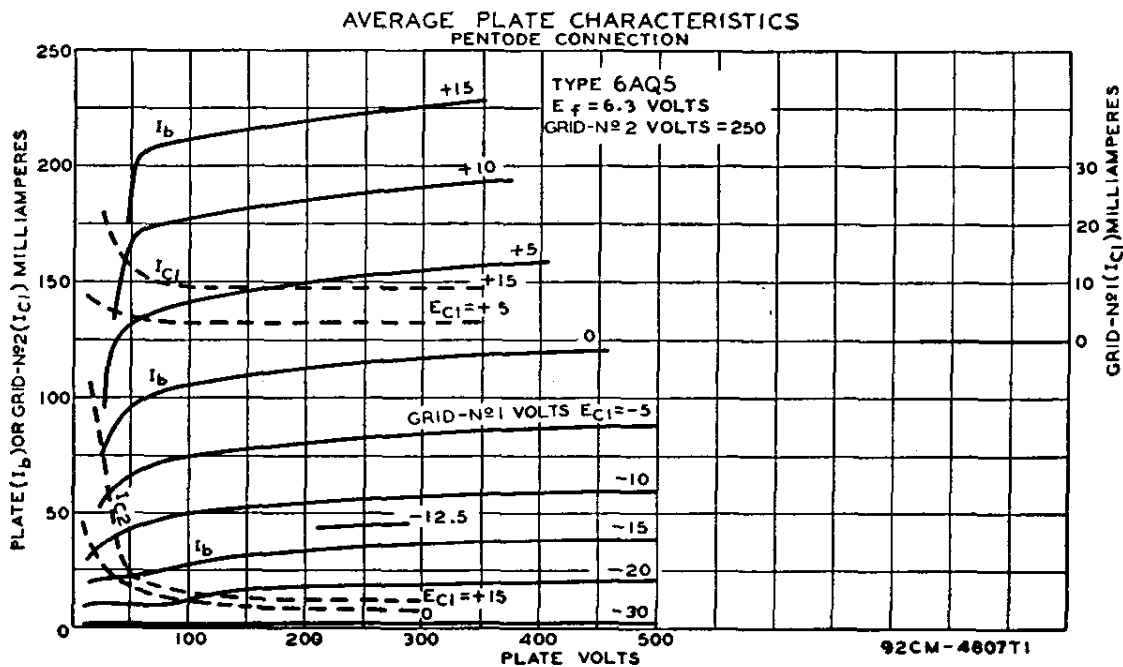

TWIN DIODE—HIGH-MU TRIODE

Miniature type used as a combined detector, amplifier, and avc tube in compact radio receivers. This type is similar to metal type 6Q7 in many of its electrical characteristics. Outline 10,

6AQ6

OUTLINES SECTION. Tube requires miniature seven-contact socket and may be mounted in any position. For typical operation as resistance-coupled amplifier, refer to Chart 7, RESISTANCE-COUPLED AMPLIFIER SECTION. For heater considerations, refer to type 6AT6.

HEATER VOLTAGE (AC/DC)	6.3	volts
HEATER CURRENT	0.15	ampere
DIRECT INTERELECTRODE CAPACITANCES (Triode Unit): ^o		
Grid to Plate	1.8	μf
Grid to Cathode and Heater	1.7	μf
Plate to Cathode and Heater	1.5	μf

^o With close-fitting shield connected to cathode.

Maximum Ratings: TRIODE UNIT AS CLASS A₁ AMPLIFIER

PLATE VOLTAGE.....	300 <i>max</i>	volts
PEAK HEATER-CATHODE VOLTAGE:		
Heater negative with respect to cathode.....	90 <i>max</i>	volts
Heater positive with respect to cathode.....	90 <i>max</i>	volts

Characteristics:

Plate Voltage.....	100	250	volts
Grid Voltage.....	-1	-3	volts
Amplification Factor.....	70	70	
Plate Resistance.....	61000	58000	ohms
Transconductance.....	1150	1200	μmhos
Plate Current.....	0.8	1.0	ma

DIODE UNITS

Two diode plates are placed around a cathode, the sleeve of which is common to the triode unit. Diode biasing of the triode unit of the 6AQ6 is not suitable. For diode operation curves, refer to type 6SQ7.

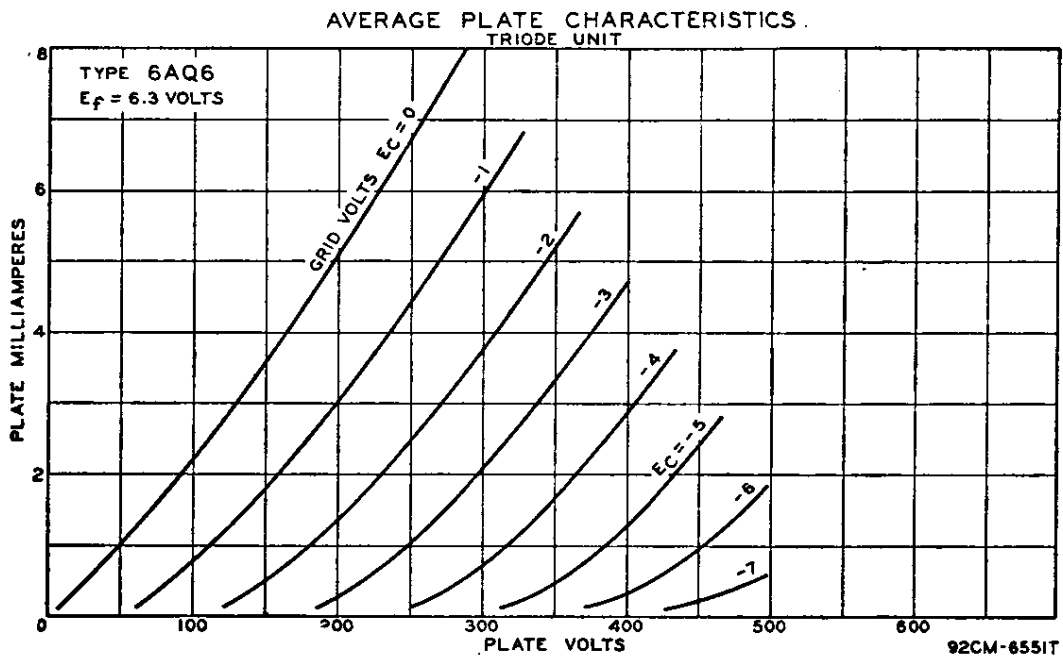

TWIN DIODE—HIGH-MU TRIODE

6AT6

Miniature type used as a combined detector, amplifier, and avc tube in automobile and ac-operated radio receivers. The 6AT6 is similar to type 6Q7 in many of its electrical characteristics and in its applications.

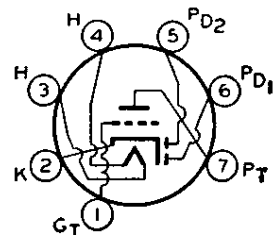

HEATER VOLTAGE (AC/DC).....	6.3	volts
HEATER CURRENT.....	0.3	ampere
DIRECT INTERELECTRODE CAPACITANCES (No external shield):		
Triode Grid to Plate.....	2.1	μμf
Triode Grid to Cathode and Heater.....	2.3	μμf
Triode Plate to Cathode and Heater.....	1.1	μμf
Diode Plate No.2 to Triode Grid.....	0.025 <i>max</i>	μμf

Maximum Ratings: TRIODE UNIT AS CLASS A₁ AMPLIFIER

PLATE VOLTAGE.....	300 <i>max</i>	volts
PEAK HEATER-CATHODE VOLTAGE:		
Heater negative with respect to cathode.....	90 <i>max</i>	volts
Heater positive with respect to cathode.....	90 <i>max</i>	volts

Characteristics:

Plate Voltage.....	100	250	volts
Grid Voltage.....	-1	-3	volts
Amplification Factor.....	70	70	
Plate Resistance.....	54000	58000	ohms
Transconductance.....	1300	1200	μmhos
Plate Current.....	0.8	1.0	ma

DIODE UNITS

The two diode plates are placed around a cathode, the sleeve of which is common to the triode unit. Each diode plate has its own base pin. For diode operation curves, refer to type 6SQ7.

INSTALLATION AND APPLICATION

Type 6AT6 requires miniature seven-contact socket and may be mounted in any position. Outline 10, OUTLINES SECTION.

When the heater is operated on ac with a transformer, the winding of the transformer which supplies the heater circuit should operate the heater at the recommended value for full-load operating conditions at average line voltage. Under any condition of operation, the heater voltage should not be allowed to rise more than 10% above the rated value. When the 6AT6 is used in automobile receivers, the heater terminals should be connected directly across a 6-volt battery.

In receivers that employ a series-heater connection, the heater of the 6AT6 may be operated in series with the heater of other types having the same heater-current rating. The current in the heater circuit of the 6AT6 should be adjusted to the rated value for the normal supply voltage. Refer to ELECTRON TUBE INSTALLATION SECTION, Filament and Heater Power Supply, for a discussion of arrangement of heaters in series-heater or "string" connection.

The cathode of the 6AT6 when operated from a transformer, should preferably be connected directly to the electrical mid-point of the heater circuit. When operated in receivers employing a 6-volt storage battery for the heater supply, the cathode circuit is tied in either directly or through bias resistors to the negative side of the dc plate supply which is furnished either by the dc power line or the ac line through a rectifier. In circuits where the cathode is not connected directly to the heater, such as in a series-heater connection, the voltage difference between the heater and cathode should be kept within the tube ratings. If the use of a large resistor is necessary between the heater and cathode in some circuit designs, it should be bypassed by a suitable filter network or objectionable hum may develop.

The triode unit of the 6AT6 is recommended for use only in resistance-coupled circuits. Refer to the RESISTANCE-COUPLED AMPLIFIER SECTION, Chart 7 for typical operating conditions.

Grid bias for the triode unit of the 6AT6 may be obtained from a fixed source, such as a fixed-voltage tap on the dc power supply or from a cathode-bias resistor. It should not be obtained by the diode-biasing method because of the probability of plate-current cutoff, even with relatively small signal voltages applied to the diode circuit.

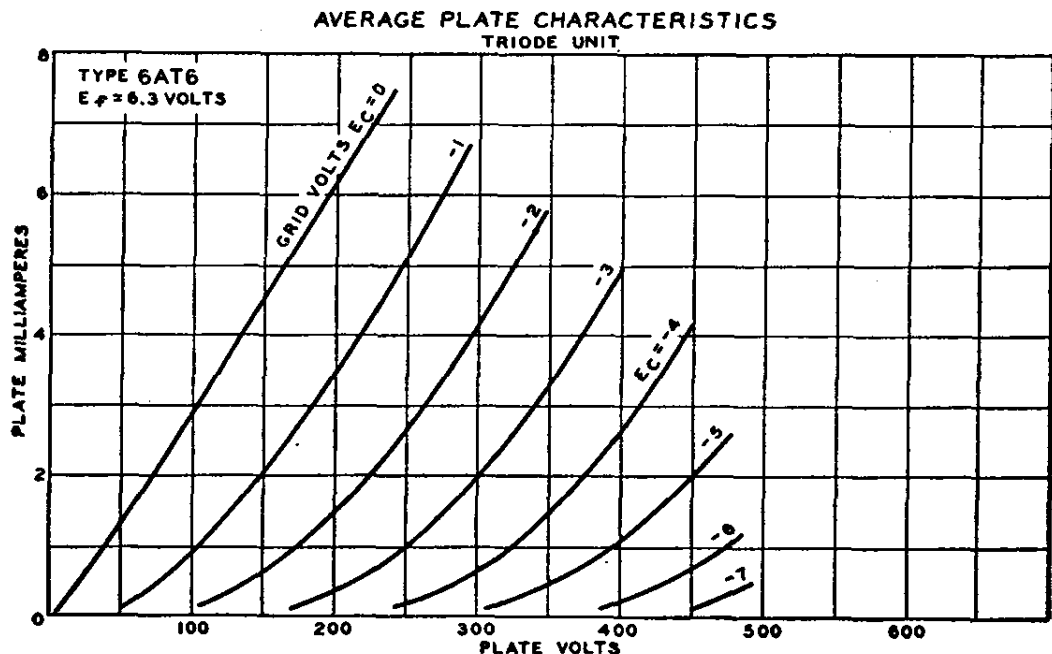

SHARP-CUTOFF PENTODE

6AU6

Miniature type used in compact radio equipment as an rf amplifier especially in high-frequency, wide-band applications. It is also used as a limiter tube in FM equipment. Outline 10,

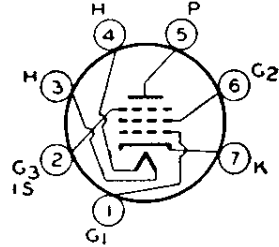

OUTLINES SECTION. Tube requires miniature seven-contact socket and may be mounted in any position. For a discussion of limiters, refer to ELECTRON TUBE APPLICATIONS SECTION. For typical operation as resistance-coupled amplifier, refer to Chart 8, RESISTANCE-COUPLED AMPLIFIER SECTION. For heater and cathode considerations, refer to type 6AT6.

HEATER VOLTAGE (AC/DC).....	6.3	volts
HEATER CURRENT.....	0.3	ampere
DIRECT INTERELECTRODE CAPACITANCES (No external shield):		
Grid No.1 to Plate.....	0.0035 max	μf
Input.....	5.5	μf
Output.....	5.0	μf

Maximum Ratings:	CLASS A ₁ AMPLIFIER		
	Triode† Connection	Pentode Connection	
PLATE VOLTAGE.....	250 max	300 max	volts
GRID-NO.2 (SCREEN) VOLTAGE.....	-	150 max	volts
GRID-NO.2 SUPPLY VOLTAGE.....	-	300 max	volts
PLATE DISSIPATION.....	3.2 max	3 max	watts
GRID-NO.2 DISSIPATION.....	-	0.65 max	watt
GRID-NO.1 (CONTROL-GRID) VOLTAGE:			
Negative bias value.....	50 max	50 max	volts
Positive bias value.....	0 max	0 max	volts
PEAK HEATER-CATHODE VOLTAGE:			
Heater negative with respect to cathode.....	90 max	90 max	volts
Heater positive with respect to cathode.....	90 max	90 max	volts

Typical Operation (Pentode Connection):

Plate Voltage.....	100	250	250	volts
Grid No.3 (Suppressor).....	Connected to cathode at socket			
Grid-No.2 Voltage.....	100	125	150	volts
Grid-No.1 Voltage.....	-1	-1	-1	volt
Plate Resistance (Approx.).....	0.5	1.5	1.0	megohms
Transconductance.....	3900	4450	5200	μmhos
Grid-No.1 Bias for plate current of 10 μa	-4.2	-5.2	-6.2	volts
Plate Current.....	5.2	7.6	10.8	ma
Grid-No. 2 Current.....	2.0	3.0	4.3	ma

Typical Operation (Triode Connection):†

Plate Voltage.....	250	volts
Grid Voltage.....	-4	volts
Amplification Factor.....	86	
Plate Resistance.....	7500	ohms
Transconductance.....	4800	μmhos
Plate Current.....	12.2	ma

† Grid No. 2 and grid No. 3 tied to plate.

AVERAGE PLATE CHARACTERISTICS
PENTODE CONNECTION

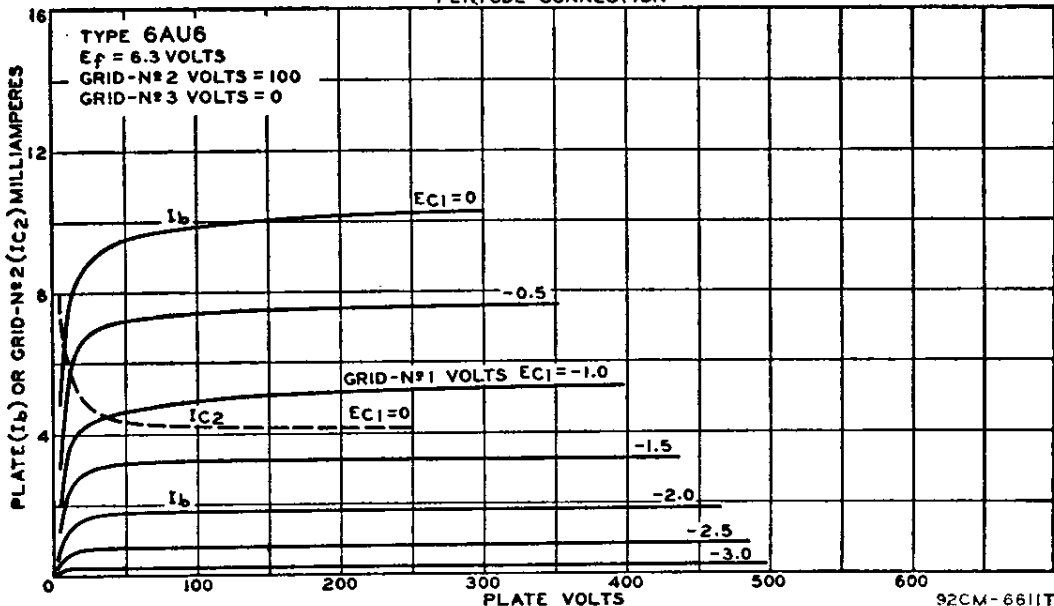

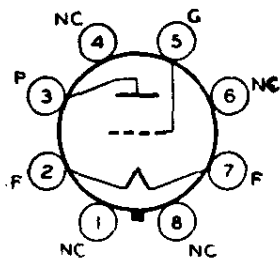

POWER TRIODE

Glass octal type used in output stage of radio receivers. Outline 33, **OUTLINES SECTION**. Tube requires octal socket. Except for filament rating (6.3 volts ac/dc; 1.0 ampere) and slightly lower power output, this type is identical electrically with type 2A3.

6B4-G

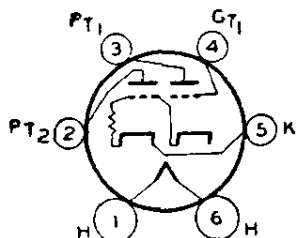

DIRECT-COUPLED POWER TRIODE

Glass type used as class A₁ power amplifier. One triode, the driver, is directly connected within the tube to the second, or output, triode. Outline 29, **OUTLINES SECTION**. Tube requires six-contact socket. Heater volts (ac/dc), 6.3; amperes, 0.8. Characteristics of input and output triodes as class A₁ amplifier follow. Input triode: plate volts, 300 *max*; grid volts, 0; plate

6B5

ma., 8. Output triode: plate volts, 300 *max*; plate ma., 45; plate resistance, 24000 ohms; load resistance, 7000 ohms; output watts, 4. This type is used principally for renewal purposes.

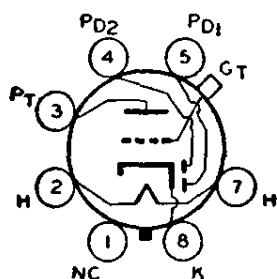

TWIN-DIODE—HIGH-MU TRIODE

Glass octal type used as combined detector, amplifier, and avc tube. Outline 26, **OUTLINES SECTION**. Tube requires octal socket. Heater volts (ac/dc), 6.3; amperes, 0.3. Within its triode maximum plate-voltage rating, this type is similar electrically to type 6SQ7 and curves under that type apply to the 6B6-G. This type is used principally for renewal purposes.

6B6-G

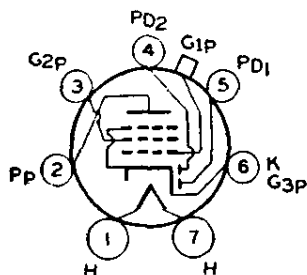

**TWIN-DIODE—
REMOTE-CUTOFF PENTODE**

Glass types used as combined detector, amplifier, and avc tubes. Outline 27, **OUTLINES SECTION**. These types fit the small seven-contact (0.75-inch, pin-circle diameter) socket. Except for interelectrode capacitances, the electrical characteristics of the 6B7 are identical with those of type 6B8-G. Type 6B7 is used principally for renewal purposes. Type 6B7S,

**6B7
6B7S**

now **DISCONTINUED**, has an external shield connected to the cathode. In general, its electrical characteristics are similar to those of the 6B7, but the two types are usually not directly interchangeable.

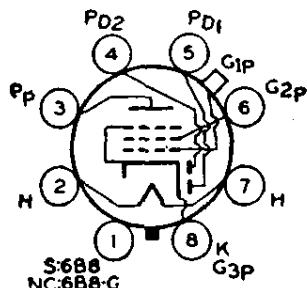

**TWIN-DIODE—
REMOTE-CUTOFF PENTODE**

Metal type 6B8 and glass octal type 6B8-G are used as combined detector, amplifier, and avc tubes. Outlines 4 and 26, respectively, **OUTLINES SECTION**. Tubes require octal socket. Type 6B8-G requires complete shielding of detector circuits. Heater volts (ac/dc), 6.3; amperes, 0.3. Maximum ratings of pentode

**6B8
6B8-G**

unit as class A₁ amplifier: plate volts, 300 *max*; grid-No.2 (screen) volts, 125 *max*; grid-No.2 supply volts, 300 *max*; grid-No.1 volts, 0 *min*; plate dissipation, 3.0 *max* watts (6B8), 2.25 *max* watts (6B8-G); grid-No. 2 dissipation, 0.3 *max* watt. For typical operation as a resistance-coupled amplifier, refer to Chart 5, **RESISTANCE-COUPLED AMPLIFIER SECTION**.

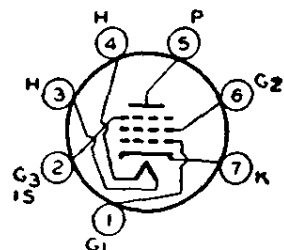

REMOTE-CUTOFF PENTODE

Miniature type used as rf amplifier in standard broadcast and FM receivers, as well as in wide-band, high-frequency applications. This type is similar in performance to metal type

6BA6

6SG7. The low value of grid-plate capacitance minimizes regenerative effects, while the high transconductance makes possible high signal-to-noise ratio.

R C A R E C E I V I N G T U B E M A N U A L

HEATER VOLTAGE (AC/DC)	6.3	volts
HEATER CURRENT	0.3	ampere
DIRECT INTERELECTRODE CAPACITANCES (No external shield):		
Grid No.1 to Plate	0.0035 <i>max</i>	$\mu\mu\text{f}$
Input	5.5	$\mu\mu\text{f}$
Output	5.0	$\mu\mu\text{f}$

Maximum Ratings:

CLASS A₁ AMPLIFIER

PLATE VOLTAGE	300 <i>max</i>	volts
GRID-NO.2 (SCREEN) VOLTAGE	125 <i>max</i>	volts
GRID-NO.2 SUPPLY VOLTAGE	300 <i>max</i>	volts
PLATE DISSIPATION	3 <i>max</i>	watts
GRID-NO.2 DISSIPATION	0.6 <i>max</i>	watt
GRID-NO.1 (CONTROL-GRID) VOLTAGE:		
Negative bias value	50 <i>max</i>	volts
Positive bias value	0 <i>max</i>	volts
PEAK HEATER-CATHODE VOLTAGE:		
Heater negative with respect to cathode	90 <i>max</i>	volts
Heater positive with respect to cathode	90 <i>max</i>	volts

Typical Operation:

Plate Voltage	100	250	volts
Grid No.3 (Suppressor)	Connected to cathode at socket		
Grid-No.2 Voltage	100	100	volts
Cathode-Bias Resistor	68	68	ohms
Plate Resistance (Approx.)	0.25	1.0	megohm
Transconductance	4300	4400	μmhos
Grid-No.1 Bias (Approx.) for transconductance of 40 μmhos ...	-20	-20	volts
Plate Current	10.8	11	ma
Grid-No.2 Current	4.4	4.2	ma

INSTALLATION AND APPLICATION

Type 6BA6 requires miniature seven-contact socket and may be mounted in any position. Outline 10, OUTLINES SECTION. For heater and cathode considerations, refer to type 6AT6.

Control-grid bias variation will be found effective in changing the volume of the receiver. In order to obtain adequate volume control, an available grid-bias voltage of approximately 50 volts will be required. The exact value will depend upon the circuit design and operating conditions. This voltage may be obtained, depending on the receiver requirements, from a potentiometer across a fixed supply voltage, from a variable cathode-bias resistor, from the avc system, or from a combination of these methods.

The **grid-No. 2 (screen)** voltage may be obtained from a potentiometer or bleeder circuit across the B-supply source, or through a dropping resistor from the plate supply. The use of series resistors for obtaining satisfactory control of grid-No.2 voltage in the case of four-electrode tubes is usually impossible because of secondary-emission phenomena. In the 6BA6, however, because grid No.3 practically removes these effects, it is practical to obtain grid-No.2 voltage through a series-dropping resistor from the plate supply or from some high intermediate voltage providing these sources do not exceed the plate-supply voltage. With this method, the grid-No.2-to-cathode voltage will fall off very little from minimum to maximum value of the resistor controlling cathode bias. In some cases, it may actually rise. This rise of grid-No.2-to-cathode voltage above the normal maximum value is allowable because both the grid-No.2 current and the plate current are reduced simultaneously by a sufficient amount to prevent damage to the tube. It should be recognized that, in general, the series-resistor method of obtaining grid-No.2 voltage from a higher voltage supply necessitates the use of the variable cathode-resistor method of controlling volume in order to prevent too high a voltage on grid No.2. When grid-No.2 and control-grid voltage are obtained in this manner, the remote "cutoff" advantage of the 6BA6 can be fully realized. However, it should be noted that the use of a resistor in the grid-No.2 circuit will have an effect on the change in plate resistance with variation in grid-No.3 (suppressor) voltage in case grid No.3 is utilized for control purposes.

Grid No. 3 (suppressor) may be connected directly to the cathode or it may be made negative with respect to the cathode. For the latter condition, the grid-No.3 voltage may be obtained from a potentiometer or bleeder circuit, or from the avc system.

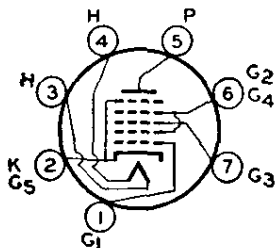
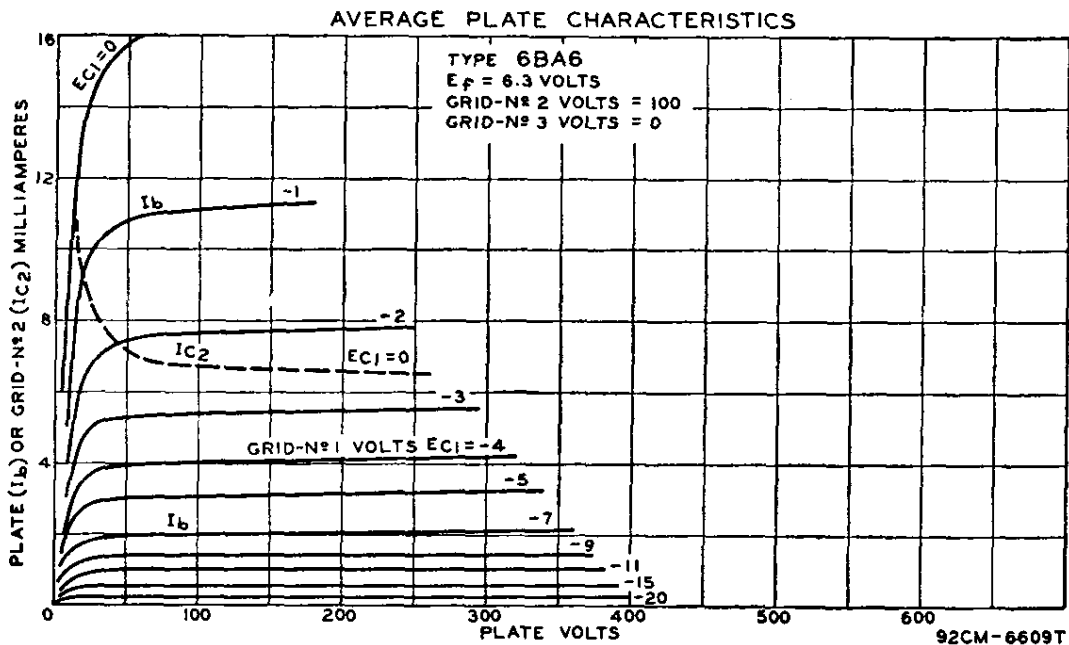

PENTAGRID CONVERTER

Miniature type used as converter in superheterodyne circuits in both the standard broadcast and FM bands. The 6BE6 is similar in performance to metal type 6SA7. For general discussion of pentagrid types, see **Frequency Conversion** in **ELECTRON TUBE APPLICATION SECTION**.

6BE6

HEATER VOLTAGE (AC/DC).....	6.3	volts
HEATER CURRENT.....	0.3	ampere
DIRECT INTERELECTRODE CAPACITANCES (No external shield):		
Grid No.3 to All Other Electrodes (RF Input).....	7.2	$\mu\mu\text{f}$
Plate to All Other Electrodes (Mixer Output).....	8.6	$\mu\mu\text{f}$
Grid No.1 to All Other Electrodes (Osc. Input).....	5.5	$\mu\mu\text{f}$
Grid No.3 to Plate.....	0.30 max	$\mu\mu\text{f}$
Grid No.1 to Grid No.3.....	0.15 max	$\mu\mu\text{f}$
Grid No.1 to Plate.....	0.05 max	$\mu\mu\text{f}$
Grid No.1 to All Other Electrodes Except Cathode.....	2.7	$\mu\mu\text{f}$
Grid No.1 to Cathode.....	2.8	$\mu\mu\text{f}$
Cathode to All Other Electrodes Except Grid No.1.....	15	$\mu\mu\text{f}$

Maximum Ratings:

CONVERTER SERVICE

PLATE VOLTAGE.....	300 max	volts
GRIDS-NO.2-AND-NO.4 VOLTAGE.....	100 max	volts
GRIDS-NO.2-AND-NO.4 SUPPLY VOLTAGE.....	300 max	volts
PLATE DISSIPATION.....	1.0 max	watt
GRIDS-NO.2-AND-NO.4 DISSIPATION.....	1.0 max	watt
TOTAL CATHODE CURRENT.....	14 max	ma
GRID-NO.3 VOLTAGE:		
Negative bias value.....	50 max	volts
Positive bias value.....	0 max	volts
PEAK HEATER-CATHODE VOLTAGE:		
Heater negative with respect to cathode.....	90 max	volts
Heater positive with respect to cathode.....	90 max	volts

Typical Operation (Separate Excitation):*

Plate Voltage.....	100	250	volts
Grids-No.2-and-No.4 (Screen) Voltage.....	100	100	volts
Grid-No.3 (Control-Grid) Voltage.....	-1.5	-1.5	volts
Grid-No.1 (Oscillator-Grid) Resistor.....	20000	20000	ohms
Plate Resistance (Approx.).....	0.5	1.0	megohm
Conversion Transconductance.....	455	475	μmhos
Conversion Transconductance (Approx.) with grid-No.3 bias of -30 volts.....	4	4	μmhos
Plate Current.....	2.8	3.0	ma
Grids-No.2-and-No.4 Current.....	8.0	7.8	ma
Grid-No.1 Current.....	0.5	0.5	ma
Total Cathode Current.....	11.3	11.3	ma

Note: The transconductance between grid No.1 and grids No.2 and No.4 connected to plate (not oscillating) is approximately 7250 μmhos under the following conditions: grids No.1 and No.3 at 0 volts; grids No.2 and No.4 and plate at 100 volts. Under the same conditions, the plate current is 25 ma., and the amplification factor is 20.

* The characteristics shown with separate excitation correspond very closely with those obtained in a self-excited oscillator circuit operating with zero bias.

INSTALLATION AND APPLICATION

Type 6BE6 requires miniature seven-contact socket and may be mounted in any position. Outline 10, OUTLINES SECTION. For heater and cathode considerations, refer to type 6AT6.

Because of the special structural arrangement of the 6BE6, a change in signal-grid voltage produces little change in cathode current. Consequently, an rf voltage on the signal grid produces little modulation of the electron current flowing in the cathode circuit. This feature is important because it is desirable that the impedance in the cathode circuit should produce little degeneration or regeneration of the signal-frequency input and intermediate-frequency output. Another important feature is that, because signal-grid voltage has very little effect on the space charge near the cathode, changes in avc bias produce little change in oscillator transconductance and in the input capacitance of grid No.1. There is, therefore, little detuning of the oscillator by avc bias.

A typical self-excited oscillator circuit employing the 6BE6 is given in the CIRCUIT SECTION.

In the 6BE6 operation characteristics curves with self-excitation, E_k is the voltage across the oscillator-coil section between cathode and ground; E_g is the oscillator voltage between cathode and grid.

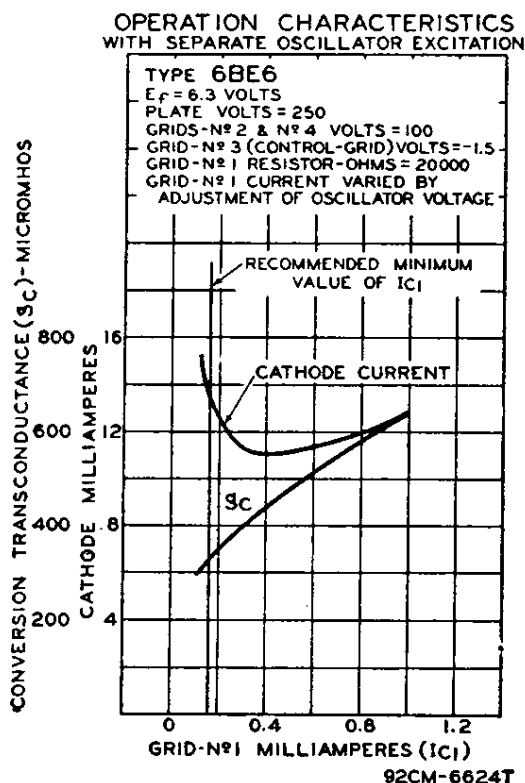
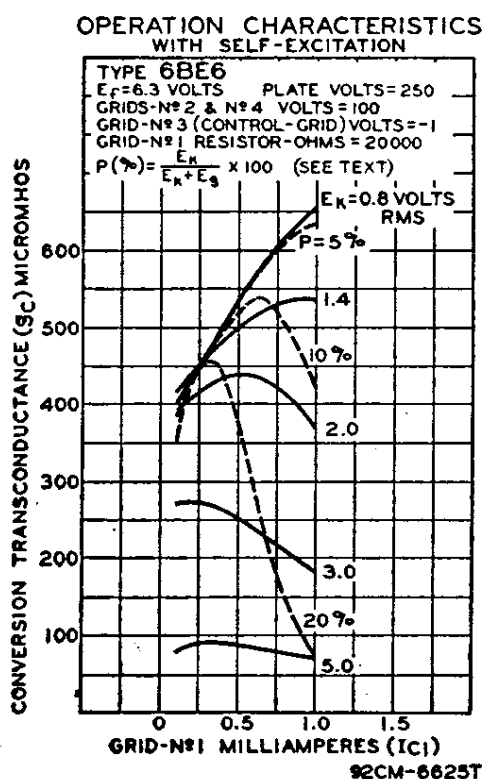

**TWIN DIODE—
MEDIUM-MU TRIODE**

6BF6

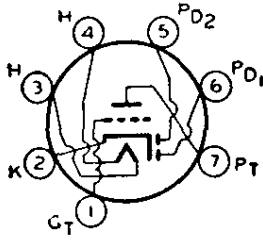

Miniature type used in compact radio equipment as combined detector, amplifier, and avc tube. The triode unit is particularly useful as a driver for impedance- or transformer-coupled

output stages in automobile receivers. It is equivalent in performance to metal type 6SR7. Outline 10, OUTLINES SECTION. Tube requires miniature seven-contact socket and may be mounted in any position. For typical operation as a resistance-coupled amplifier, refer to Chart 9, RESISTANCE-COUPLED AMPLIFIER SECTION. For heater and cathode considerations, refer to type 6AT6.

HEATER VOLTAGE (AC/DC).....	6.3	volts
HEATER CURRENT.....	0.3	ampere
DIRECT INTERELECTRODE CAPACITANCES (Triode Unit):		
Grid to Plate.....	2.0*	$\mu\mu\text{f}$
Grid to Cathode.....	1.8*	$\mu\mu\text{f}$
Plate to Cathode.....	1.4*	$\mu\mu\text{f}$

* With external shield connected to cathode.

Maximum Ratings: TRIODE UNIT AS CLASS A₁ AMPLIFIER

PLATE VOLTAGE.....	300 <i>max</i>	volts
PLATE DISSIPATION.....	2.5 <i>max</i>	watts
PEAK HEATER-CATHODE VOLTAGE:		
Heater negative with respect to cathode.....	90 <i>max</i>	volts
Heater positive with respect to cathode.....	90 <i>max</i>	volts

Typical Operation (With Transformer Coupling):

Plate Voltage.....	250	volts
Grid Voltage.....	-9	volts
Amplification Factor.....	16	
Plate Resistance.....	8500	ohms
Transconductance.....	1900	μmhos
Plate Current.....	9.5	ma
Load Resistance.....	10000	ohms
Total Harmonic Distortion.....	6.5	per cent
Power Output.....	300	mw

DIODE UNITS

The two diode plates and the triode unit have a common cathode. Diode biasing of the triode unit of the 6BF6 is not suitable. For diode operation curves, refer to type 6SQ7.

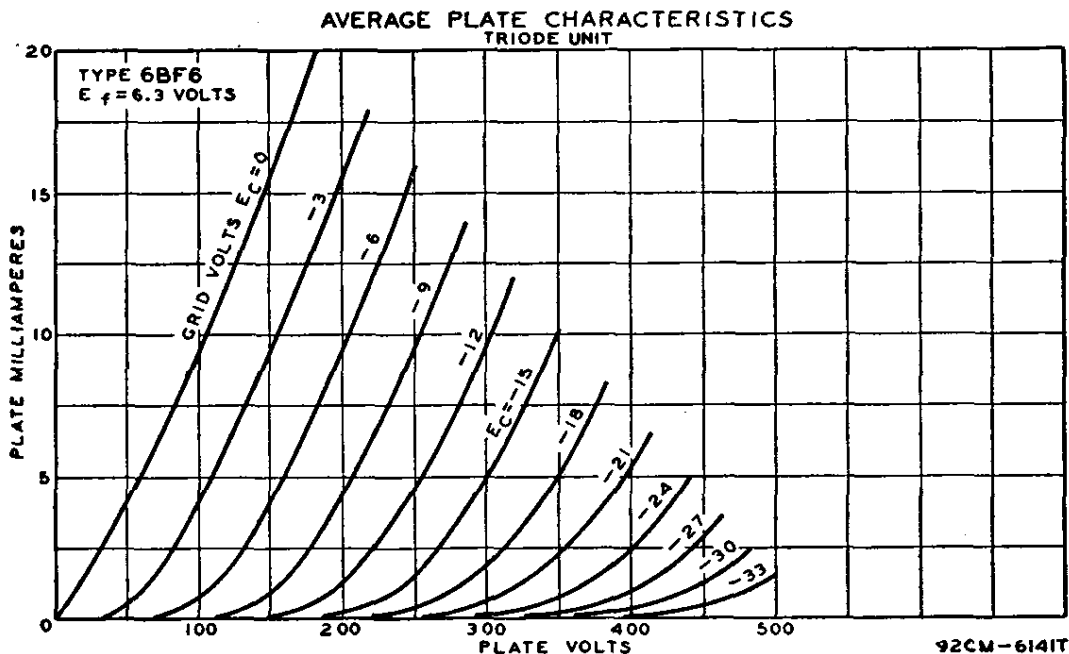

BEAM POWER AMPLIFIER

6BG6-G

Glass octal type used as output amplifier in horizontal-deflection circuits of television equipment where high surge voltages occur during short duty cycles. A single 6BG6-G is capable of deflecting all types of directly viewed magnetic-deflection kinescopes having deflection angles not greater than 50° and operating at anode voltages not exceeding 10 kilovolts. Outline 35, OUTLINES SECTION. Tube requires octal socket. Vertical tube mounting is preferred but horizontal operation is permissible if pins No.2 and 7 are in vertical plane.

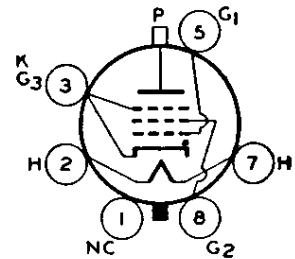

HEATER VOLTAGE (AC/DC)	6.3	volts
HEATER CURRENT	0.9	ampere
DIRECT INTERELECTRODE CAPACITANCES (No external shield):		
Grid No.1 to Plate	0.50 max	μf
Input	11	μf
Output	6.5	μf
TRANSCONDUCTANCE FOR PLATE CURRENT OF 70 MA	6000	μmhos
GRID-SCREEN MU-FACTOR	8	

Maximum Ratings:

DEFLECTION AMPLIFIER

DC PLATE VOLTAGE	500 max	volts
PEAK POSITIVE SURGE PLATE VOLTAGE*	6000 max	volts
DC GRID-NO.2 (SCREEN) VOLTAGE†	350 max	volts
DC GRID-NO.1 (CONTROL-GRID) VOLTAGE	-50 max	volts
PEAK NEGATIVE SURGE GRID-NO.1 VOLTAGE*	-400 max	volts
DC PLATE CURRENT	100 max	ma
GRID-NO.2 INPUT	3.2 max	watts
PLATE DISSIPATION	20 max	watts
PEAK HEATER-CATHODE VOLTAGE:		
Heater negative with respect to cathode	135 max	volts
Heater positive with respect to cathode	135 max	volts

* The duty cycle of the voltage pulse must not exceed 15% of one scanning cycle and its duration must be limited to 10 microseconds.

† Preferably obtained from plate-voltage supply through a series dropping resistor of sufficient magnitude to limit the grid-No.2 input to the rated maximum value for wide variation in grid-No.2 current.

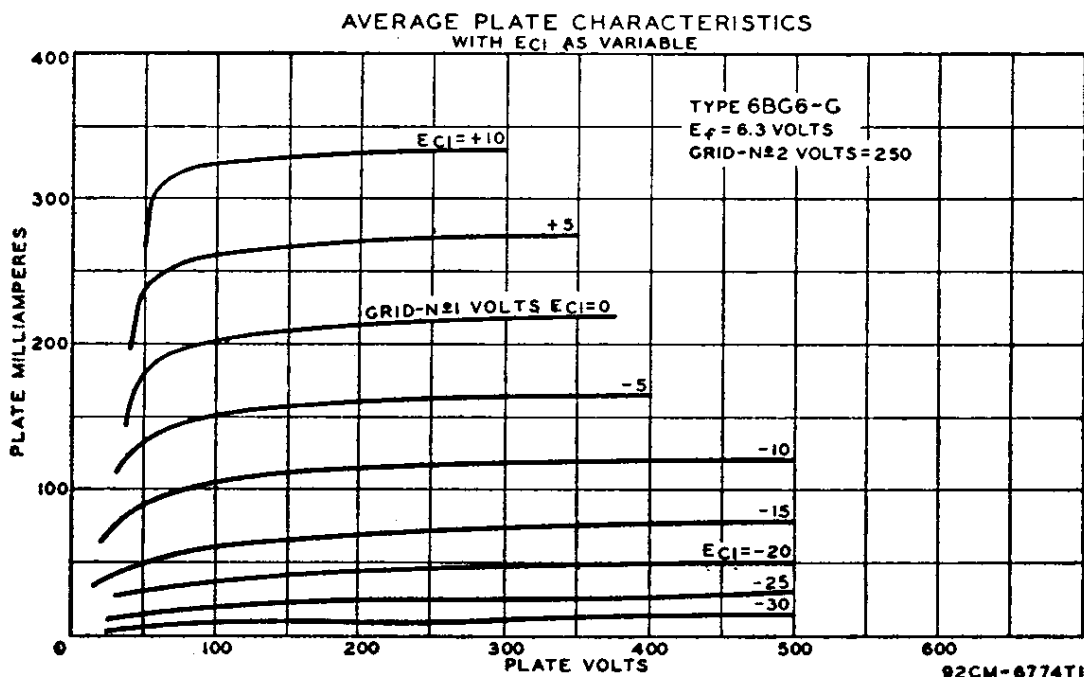

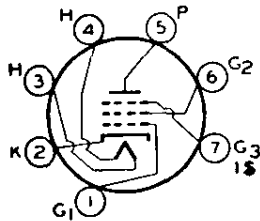

REMOTE-CUTOFF PENTODE

6BJ6

Miniature type used as rf amplifier in high-frequency and wide-band applications. Features high transconductance and low grid-to-plate capacitance. Outline 10, OUTLINES SEC-

TION. Tube requires miniature seven-contact socket and may be mounted in any position. For heater and cathode considerations, refer to type 6AT6.

HEATER VOLTAGE (AC/DC)	6.3	volts
HEATER CURRENT	0.15	ampere
DIRECT INTERELECTRODE CAPACITANCES (No external shield):		
Grid No.1 to Plate	0.0035 <i>max</i>	$\mu\mu\text{f}$
Input	4.5	$\mu\mu\text{f}$
Output	5.0	$\mu\mu\text{f}$

Maximum Ratings:

CLASS A₁ AMPLIFIER

PLATE VOLTAGE	300 <i>max</i>	volts
GRID-NO.2 (SCREEN) VOLTAGE	125 <i>max</i>	volts
GRID-NO.2 SUPPLY VOLTAGE	300 <i>max</i>	volts
PLATE DISSIPATION	3 <i>max</i>	watts
GRID-NO.2 DISSIPATION	0.6 <i>max</i>	watt
GRID-NO.1 (CONTROL-GRID) VOLTAGE:		
Negative bias value	50 <i>max</i>	volts
Positive bias value	0 <i>max</i>	volts
PEAK HEATER-CATHODE VOLTAGE:		
Heater negative with respect to cathode	90 <i>max</i>	volts
Heater positive with respect to cathode	90 <i>max</i>	volts

Typical Operation:

Plate Voltage	100	250	volts
Grid No.3 (Suppressor)	Connected to cathode at socket		
Grid-No.2 Voltage	100	100	volts
Grid-No.1 Voltage	-1.0	-1.0	volt
Plate Resistance (Approx.)	0.25	1.3	megohms
Transconductance	3650	3800	μmhos
Grid-No.1 Bias (Approx.) for transconductance of 15 μmhos	-20	-20	volts
Plate Current	9.0	9.2	ma
Grid-No.2 Current	3.5	3.3	ma

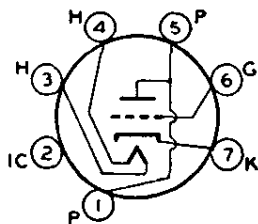

HF TRIODE

6C4

Miniature type used in compact radio equipment as a local oscillator in FM and other high-frequency circuits. It may also be used as a class C rf amplifier. In such service, it delivers

a power output of 5.5 watts at moderate frequencies, and 2.5 watts at 150 megacycles. Outline 10, OUTLINES SECTION. Tube requires miniature seven-contact socket and may be mounted in any position. For typical operation as a resistance-coupled amplifier, refer to Chart 10, RESISTANCE-COUPLED AMPLIFIER SECTION. For heater and cathode considerations, refer to type 6AT6.

HEATER VOLTAGE (AC/DC)	6.3	volts
HEATER CURRENT	0.15	ampere
DIRECT INTERELECTRODE CAPACITANCES (No external shield):		
Grid to Plate	1.6	$\mu\mu\text{f}$
Grid to Cathode	1.8	$\mu\mu\text{f}$
Plate to Cathode	1.3	$\mu\mu\text{f}$

Maximum Ratings:

CLASS A₁ AMPLIFIER

PLATE VOLTAGE	300 <i>max</i>	volts
PLATE DISSIPATION	3.5 <i>max</i>	watts
PEAK HEATER-CATHODE VOLTAGE:		
Heater negative with respect to cathode	90 <i>max</i>	volts
Heater positive with respect to cathode	90 <i>max</i>	volts

Characteristics:

Plate Voltage.....	100	250	volts
Grid Voltage*.....	0	-8.5	volts
Amplification Factor.....	19.5	17	
Plate Resistance.....	6250	7700	ohms
Transconductance.....	3100	2200	μ mhos
Plate Current.....	11.8	10.5	ma

* The type of input coupling used should not introduce too much resistance in the grid circuit. Transformer- or impedance-coupling devices are recommended. Under maximum rated conditions, the resistance in the grid circuit should not exceed 0.25 megohm with fixed bias, or 1.0 megohm with cathode bias.

RF POWER AMPLIFIER AND OSCILLATOR—Class C Telegraphy

Maximum Ratings:

DC PLATE VOLTAGE.....	300 <i>max</i>	volts
DC GRID VOLTAGE.....	-50 <i>max</i>	volts
DC PLATE CURRENT.....	25 <i>max</i>	ma
DC GRID CURRENT.....	8 <i>max</i>	ma
PLATE DISSIPATION.....	5 <i>max</i>	watts

Typical Operation (At Moderate Frequencies):

DC Plate Voltage.....	300	volts
DC Grid Voltage.....	-27	volts
DC Plate Current.....	25	ma
DC Grid Current (Approx.).....	7	ma
Driving Power (Approx.).....	0.35	watt
Power Output (Approx.).....	5.5	watts

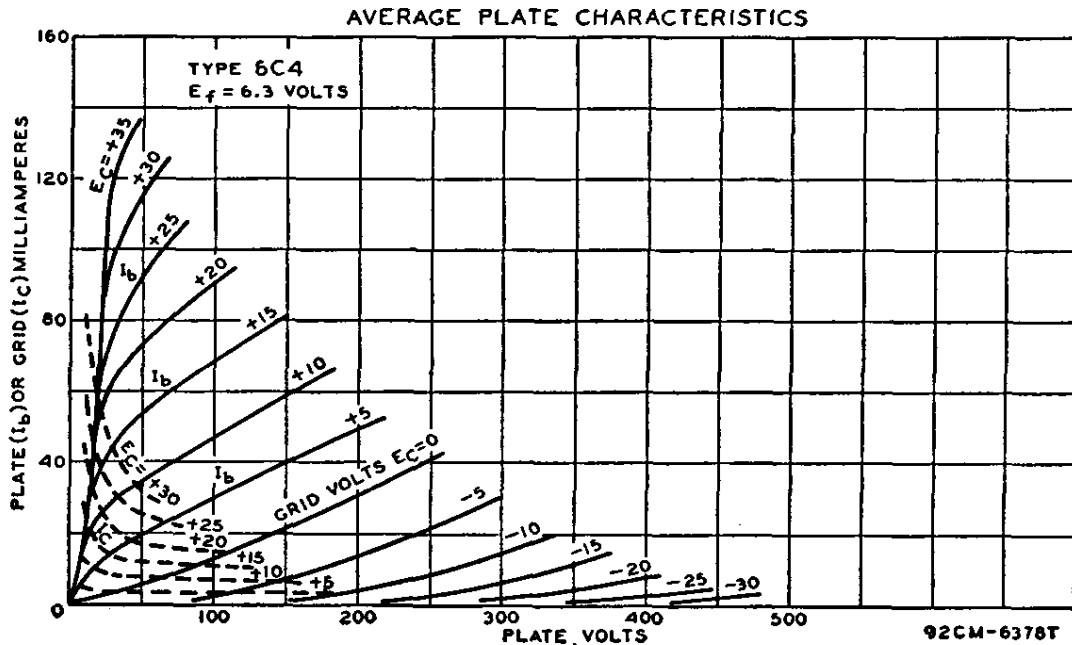

6C5 6C5-GT

MEDIUM-MU TRIODE

Metal type 6C5 and glass-octal type 6C5-GT used as audio amplifier and oscillator. They are also used as detectors of grid-resistor-and-capacitor type or grid-bias type. Outlines 3 and 19, respectively, OUTLINES SECTION. Tubes require octal socket and may be mounted in any position. Heater volts (ac/dc), 6.3; amperes, 0.3. Maximum ratings as class A₁ amplifier:

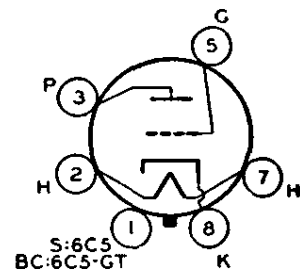
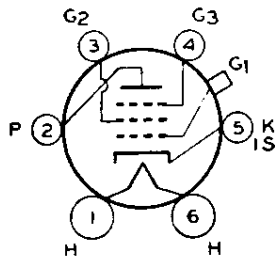

plate volts, 300 *max*; plate dissipation, 2.5 *max* watts; grid volts, 0 *min*. Typical operation: plate volts, 250; grid volts, -8 (grid-circuit resistance should not exceed 1.0 megohm); amplification factor, 20; plate resistance, 10000 ohms; transconductance, 2000 μ mhos; plate ma., 8. For typical operation as a resistance-coupled amplifier, refer to Chart 11, RESISTANCE-COUPLED AMPLIFIER SECTION.



SHARP-CUTOFF PENTODE

Glass type used as biased detector and as a high-gain amplifier in radio equipment. Outline 31, OUTLINES SECTION. Tube requires six-contact socket. Heater volts (ac/dc), 6.3; amperes, 0.3. For ratings and typical operation data, refer to type 6J7. This type is used principally for renewal purposes.

6C6

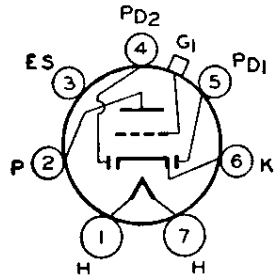

**TWIN DIODE—
MEDIUM-MU TRIODE**

Glass type used as combined detector, amplifier, and avc tube. Outline 27, OUTLINES SECTION. Heater volts (ac/dc), 6.3; amperes, 0.3. This type is similar to, but not interchangeable with, type 85. The 6C7 is a DISCONTINUED type listed for reference only.

6C7

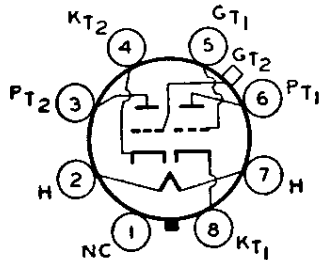

MEDIUM-MU TWIN TRIODE

Glass octal type used as a voltage amplifier and phase inverter in radio equipment. Outline 26, OUTLINES SECTION. When this type is used in a high-gain amplifier, hum may be reduced or eliminated by grounding pin No.7 or by grounding the arm of a 100-to-500-ohm potentiometer across the heater terminals. Tube requires octal socket. Heater volts (ac/dc), 6.3; amperes, 0.3. Maximum ratings for each triode unit as class A₁ amplifier: plate volts, 250 *max*; grid volts, 0 *min*; plate dissipation, 1.0 *max* watt. Typical operation: plate volts, 250; grid volts, -4.5; plate ma., 3.2; plate resistance, 22500 ohms; amplification factor, 36; transconductance, 1600 μ mhos. For typical operation as a resistance-coupled amplifier, refer to Chart 12, RESISTANCE-COUPLED AMPLIFIER SECTION.

6C8-G

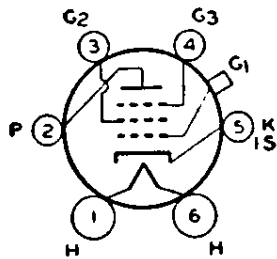

REMOTE-CUTOFF PENTODE

Glass type used in rf and if stages of radio receivers employing avc. Outline 31, OUTLINES SECTION. Tube requires six-contact socket. Except for interelectrode capacitances, this type is identical electrically with type 6U7-G. Refer to type 6SK7 for general application information. Heater volts (ac/dc), 6.3; amperes, 0.3. This type is used principally for renewal purposes.

6D6

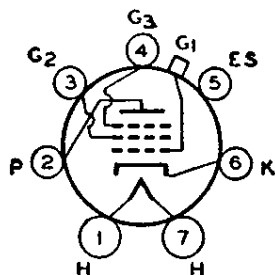

SHARP-CUTOFF PENTODE

Glass type used as detector or amplifier in radio receivers. Outline 31, OUTLINES SECTION. Heater volts (ac/dc), 6.3; amperes, 0.3. For electrical characteristics, refer to type 6J7. This is a DISCONTINUED type listed for reference only.

6D7

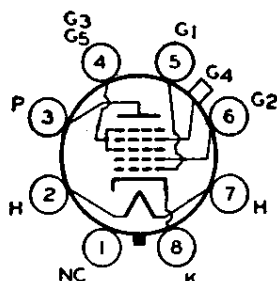

PENTAGRID CONVERTER

Glass octal type used in superheterodyne circuits. Outline 26, OUTLINES SECTION. Tube requires octal socket. Heater volts (ac/dc), 6.3; amperes, 0.15. Except for interelectrode capacitances and heater rating, the 6D8-G is similar electrically to type 6A8-G. The 6D8-G is used principally for renewal purposes.

6D8-G

ELECTRON-RAY TUBE

6E5

Glass type used to indicate visually by means of a fluorescent target the effects of a change in a controlling voltage. It is used as a convenient means of indicating accurate radio-receiver tuning. Outline 23, OUTLINES SECTION. Tube requires six-contact socket. Heater volts (ac/dc), 6.3; amperes, 0.3. For additional considerations, refer to **Tuning Indication with Electron-Ray Tubes** in ELECTRON TUBE APPLICATIONS SECTION.

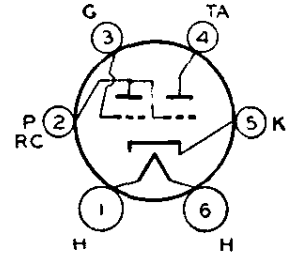

Maximum Ratings:

TUNING INDICATOR

PLATE-SUPPLY VOLTAGE.....	250 max	volts
TARGET VOLTAGE.....	{ 250 max	volts
	{ 125 min	volts

Typical Operation:

Plate and Target Supply.....	125	250	volts
Series Triode-Plate Resistor.....	1	1	megohm
Target Current*†.....	0.8	2	ma
Triode-Plate Current*.....	0.1	0.2	ma
Triode-Grid Voltage (Approx.):			
For shadow angle of 0°.....	-4.0	-7.5	volts
For shadow angle of 90°.....	0	0	volts

* For zero triode-grid voltage. † Subject to wide variations.

TWIN POWER TRIODE

6E6

Glass type used as class A₁ amplifier in either push-pull or parallel circuits. Outline 29, OUTLINES SECTION. Heater volts (ac/dc), 6.3; amperes, 0.6. With plate volts of 250 and grid volts of -27.5, characteristics for each unit are: plate ma., 18; plate resistance, 3500 ohms; transconductance, 1700 μmhos; amplification factor, 6. With plate-to-plate load resistance of 14000 ohms, output watts for two tubes is 1.6. This is a DISCONTINUED type listed for reference only.

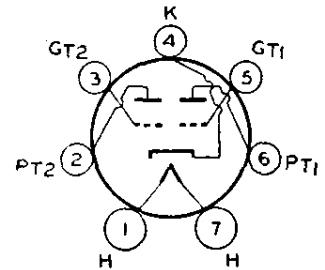

REMOTE-CUTOFF PENTODE

6E7

Glass type used in rf and if stages of radio receivers employing avc. Outline 31, OUTLINES SECTION. Except for interelectrode capacitances, this type is identical electrically with type 6U7-G. Heater volts (ac/dc), 6.3; amperes, 0.3. This is a DISCONTINUED type listed for reference only.

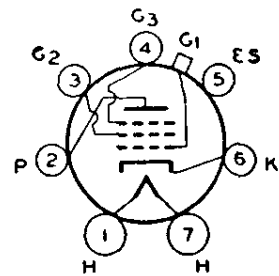

HIGH-MU TRIODE

6F5
6F5-GT

Metal type 6F5 and glass-octal type 6F5-GT used in resistance-coupled amplifier circuits. Outlines 4 and 16, respectively, OUTLINES SECTION. Tubes require octal socket and may

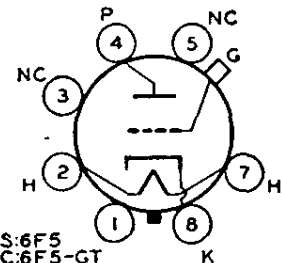

be mounted in any position. For typical operation as a resistance-coupled amplifier, refer to Chart 18, RESISTANCE-COUPLED AMPLIFIER SECTION. For heater and cathode considerations, refer to type 6AT6.

HEATER VOLTAGE (AC/DC).....	6.3	volts
HEATER CURRENT.....	0.3	ampere

Characteristics:
CLASS A₁ AMPLIFIER

Plate Voltage (300 volts <i>max</i>)	100	250	volts
Grid Voltage	-1	-2	volts
Amplification Factor	100	100	
Plate Resistance	85000	66000	ohms
Transconductance	1150	1500	μmhos
Plate Current	0.4	0.9	ma

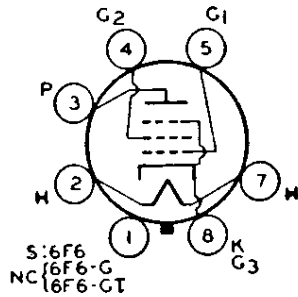
POWER PENTODE

Metal type 6F6 and glass-octal types 6F6-G and 6F6-GT are used in the audio output stage of ac receivers. They are capable of large power output with relatively small input voltage.

6F6 6F6-G 6F6-GT

Outlines 6, 28, and 21, respectively, **OUTLINES SECTION**. Tubes require octal socket and may be mounted in any position. It is especially important that these tubes, like other power-handling tubes, should be adequately ventilated.

HEATER VOLTAGE (AC/DC)	6.3	volts
HEATER CURRENT	0.7	ampere

Maximum Ratings:
SINGLE-TUBE CLASS A₁ AMPLIFIER

PLATE VOLTAGE	375 <i>max</i>	volts
GRID-NO.2 (SCREEN) VOLTAGE	285 <i>max</i>	volts
PLATE DISSIPATION	11 <i>max</i>	watts
GRID-NO.2 DISSIPATION	3.75 <i>max</i>	watts
PEAK HEATER-CATHODE VOLTAGE:		
Heater negative with respect to cathode	90 <i>max</i>	volts
Heater positive with respect to cathode	90 <i>max</i>	volts

Typical Operation:
Fixed Bias
Cathode Bias

Plate Voltage	250	285	250	285	volts
Grid-No.2 Voltage	250	285	250	285	volts
Grid-No.1 (Control-Grid) Voltage	-16.5	-20	-	-	volts
Cathode Resistor	-	-	410	440	ohms
Peak AF Grid Voltage	16.5	20	16.5	20	volts
Zero-Signal Plate Current	34	38	34	38	ma
Maximum-Signal Plate Current	36	40	35	38	ma
Zero-Signal Grid-No.2 Current	6.5	7	6.5	7	ma
Maximum-Signal Grid-No.2 Current	10.5	13	9.7	12	ma
Plate Resistance (Approx.)	80000	78000	-	-	ohms
Transconductance	2500	2550	-	-	μmhos
Load Resistance	7000	7000	7000	7000	ohms
Total Harmonic Distortion	8	9	8.5	9	per cent
Maximum-Signal Power Output	3.2	4.8	3.1	4.5	watts

Maximum Ratings:
PUSH-PULL CLASS A₁ AMPLIFIER

(Same as for single-tube class A₁ amplifier)

Typical Operation (Values are for two tubes):
Fixed Bias
Cathode Bias

Plate Voltage	315	315	volts
Grid-No.2 Voltage	285	285	volts
Grid-No.1 (Control-Grid) Voltage	-24	-	volts
Cathode Resistor	-	320	ohms
Peak AF Grid-No.1-to-Grid-No.1 Voltage	48	58	volts
Zero-Signal Plate Current	62	62	ma
Maximum-Signal Plate Current	80	73	ma
Zero-Signal Grid-No.2 Current	12	12	ma
Maximum-Signal Grid-No.2 Current	19.5	18	ma
Effective Load Resistance (Plate-to-plate)	10000	10000	ohms
Total Harmonic Distortion	4	3	per cent
Maximum-Signal Power Output	11	10.6	watts

6F7

**TRIODE—
REMOTE-CUTOFF PENTODE**

Glass type adaptable to circuit design in several ways. Except for common cathode, the triode and pentode units are independent of each other. Outline 27, OUTLINES SECTION. Heater volts (ac/dc), 6.3; amperes, 0.3

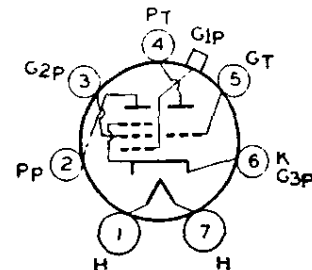

CLASS A₁ AMPLIFIER

Maximum Ratings:

	<i>Triode Unit</i>	<i>Pentode Unit</i>	
PLATE VOLTAGE.....	100 <i>max</i>	250 <i>max</i>	volts
PLATE-SUPPLY VOLTAGE.....	250 <i>max</i>	250 <i>max</i>	volts
GRID-NO.2 (SCREEN) VOLTAGE.....	-	100 <i>max</i>	volts
GRID-NO.1 (CONTROL-GRID) VOLTAGE.....	-3 <i>min</i>	-3 <i>min</i>	volts
PEAK HEATER-CATHODE VOLTAGE:			
Heater negative with respect to cathode.....	90 <i>max</i>	90 <i>max</i>	volts
Heater positive with respect to cathode.....	90 <i>max</i>	90 <i>max</i>	volts

Typical Operation and Characteristics:

	<i>Triode Unit</i>	<i>Pentode Unit</i>		
Plate Voltage.....	100	100	250	volts
Grid-No.2 Voltage.....	-	100	100	volts
Grid-No.1 Voltage.....	-3	-3	-3	volts
Amplification Factor.....	8	-	-	
Plate Resistance.....	0.016	0.29	0.85	megohm
Transconductance.....	500	1050	1100	μmhos
Transconductance at -35-volts bias.....	-	9	10	μmhos
Plate Current.....	3.5	6.3	6.5	ma
Grid-No.2 Current.....	-	1.6	1.5	ma

MEDIUM-MU TWIN TRIODE

Glass octal type used as voltage amplifier or phase inverter in radio equipment. Except for common heater each triode is independent of the other. Outline 26, OUTLINES SECTION. Tube requires octal socket. Except for the heater rating of 6.3 volts (ac/dc) and 0.6 ampere and interelectrode capacitances, each triode unit is identical electrically with type 6J5. For typical operation as a resistance-coupled amplifier, refer to Chart 13, RESISTANCE-COUPLED AMPLIFIER SECTION.

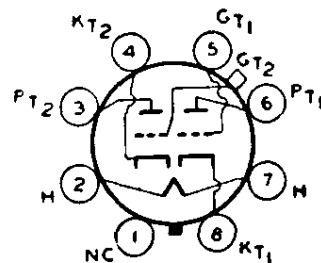

6F8-G

POWER PENTODE

Glass octal type used in output stage of radio receivers where moderate power output is required. This type is economical because of its low plate-power requirements and low heater current. Outline 24, OUTLINES SECTION. Tube requires octal socket. Except for interelectrode capacitances and a plate resistance of 175000 ohms, this type is electrically identical with type 6AK6. Heater volts (ac/dc), 6.3; amperes, 0.15.

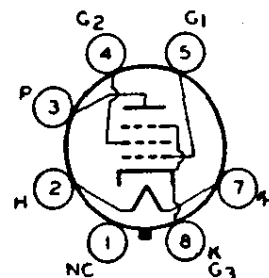

6G6-G

TWIN DIODE

Metal type 6H6 and glass-octal type 6H6-GT are used as detectors, low-voltage rectifiers, and avc tubes. Except for the common heater, the two diode units are independent of

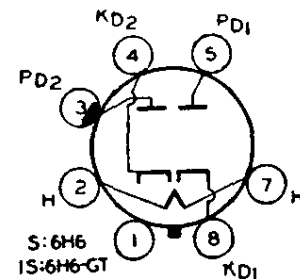

**6H6
6H6-GT**

each other. For diode detector considerations, refer to ELECTRON TUBE APPLICATIONS SECTION.

RCA RECEIVING TUBE MANUAL

HEATER VOLTAGE (AC/DC).....	6.3	volts
HEATER CURRENT.....	0.3	ampere
DIRECT INTERELECTRODE CAPACITANCES:†		

	6H6	6H6-GT	
Plate No.1 to Cathode No.1.....	3.0	3.0	μf
Plate No.2 to Cathode No.2.....	3.4	4.0	μf
Plate No.1 to Plate No.2.....	0.1 max	0.1 max	μf

† With shell or external and internal shields connected to cathode.

Maximum Ratings:

RECTIFIER OR DOUBLER

PEAK INVERSE PLATE VOLTAGE.....	420 max	volts
PEAK PLATE CURRENT PER PLATE.....	48 max	ma
DC OUTPUT CURRENT PER PLATE.....	8 max	ma
PEAK HEATER-CATHODE VOLTAGE.....	330 max	volts

Typical Operation (As Half-Wave Rectifier):*

AC Plate Voltage per Plate (RMS).....	117	150	volts
Min. Total Effective Plate-Supply Impedance per Plate ^o	15	40	ohms
DC Output Current per Plate.....	8	8	ma

Typical Operation (As Voltage Doubler):

	Half-Wave	Full-Wave	
AC Plate Voltage per Plate (RMS).....	117	117	volts
Min. Total Effective Plate-Supply Impedance per Plate ^o	30	15	ohms
DC Output Current.....	8	8	ma

* In half-wave service, the two units may be used separately or in parallel.

^o When a filter-input capacitor larger than 40 μf is used, it may be necessary to use more plate-supply impedance than the value shown to limit the peak plate current to the rated value.

INSTALLATION AND APPLICATION

Types 6H6 and 6H6-GT require an octal socket and may be mounted in any position. Outlines 1 and 17 respectively, OUTLINES SECTION. For heater and cathode considerations, refer to type 6AT6.

For detection, the diodes may be utilized in a full-wave circuit or in a half-wave circuit. In the latter case, one plate only, or the two plates in parallel, may be employed. For the same signal voltage, the use of the half-wave arrangement will provide approximately twice the rectified voltage as compared with the full-wave arrangement.

For automatic-volume control, the 6H6 and 6H6-GT may be used in circuits similar to those employed for any of the twin-diode types of tubes. The only difference is that the 6H6 and 6H6-GT are more adaptable because each diode has its own separate cathode.

Since the diodes by themselves do not provide any amplification, it is usually necessary to provide gain by means of a supplementary tube. Types such as the 6J5, 6SJ7, and 6AU6 are very suitable for this purpose. Their use in combination with the 6H6 or 6H6-GT is similar to that of the amplifier sections of twin-diode triode or pentode types.

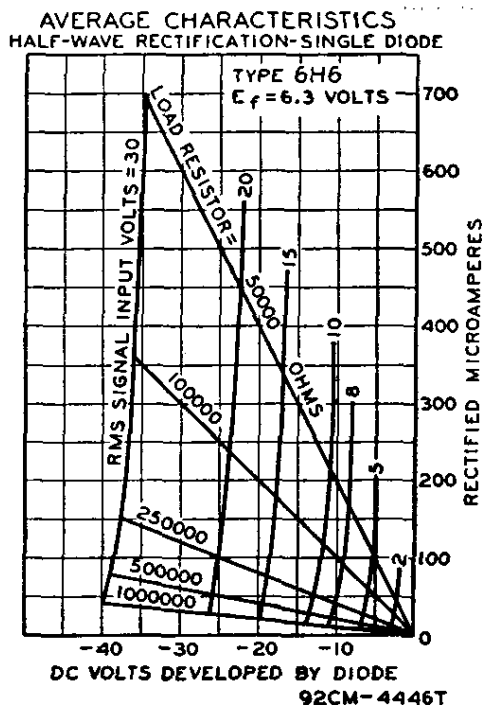

MEDIUM-MU TRIODE

6J5
6J5-GT

Metal type 6J5 and glass-octal type 6J5-GT used as detectors, amplifiers, or oscillators in radio equipment. These types feature high transconductance together with comparatively

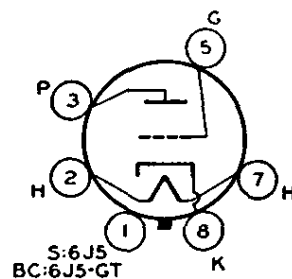

high amplification factor. Outlines 3 and 19, respectively, OUTLINES SECTION. Tubes require octal socket and may be mounted in any position. For heater and cathode considerations, refer to type 6AT6. For typical operation as a resistance-coupled amplifier, refer to Chart 13, RESISTANCE COUPLED AMPLIFIER SECTION.

HEATER VOLTAGE (AC/DC).....	6.3	volts	
HEATER CURRENT.....	0.3	ampere	
DIRECT INTERELECTRODE CAPACITANCES (Approx.):	6J5*	6J5-GT**	
Grid to Plate.....	3.4	3.8	μf
Grid to Cathode.....	3.4	4.2	μf
Plate to Cathode.....	3.6	5.0	μf

* Shell connected to cathode.

** Close-fitting shield connected to cathode.

Maximum Ratings:

CLASS A₁ AMPLIFIER

PLATE VOLTAGE.....	300 max	volts
GRID VOLTAGE.....	0 min	volts
PLATE DISSIPATION.....	2.5 max	watts
PEAK HEATER-CATHODE VOLTAGE:		
Heater negative with respect to cathode.....	90 max	volts
Heater positive with respect to cathode.....	90 max	volts
CATHODE CURRENT.....	20 max	ma

Typical Operation:

Plate Voltage.....	90	250	volts
Grid Voltage†.....	0	-8	volts
Amplification Factor.....	20	20	
Plate Resistance.....	6700	7700	ohms
Transconductance.....	3000	2600	μmhos
Plate Current.....	10	9	ma

† Under maximum rated conditions, the dc resistance in the grid circuit should not exceed 1.0 megohm.

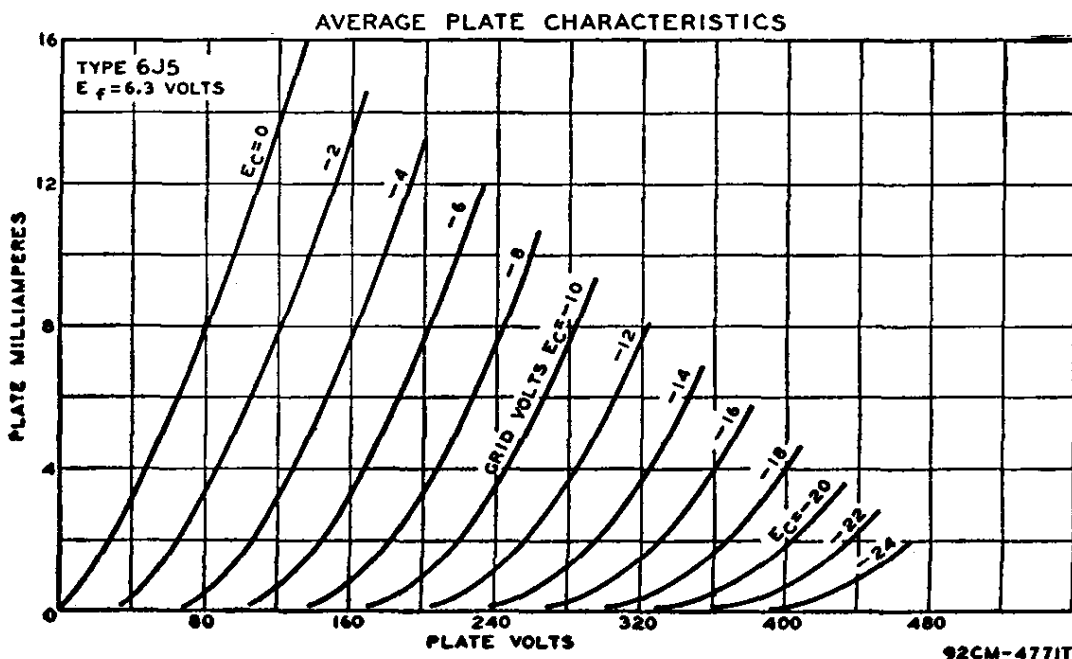

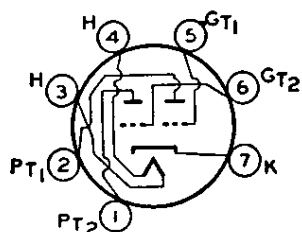

MEDIUM-MU TWIN TRIODE

6J6

Miniature type used as an rf power amplifier and oscillator or as an af amplifier. With a push-pull arrangement of the grids and with the plates in parallel, it is also used as a mixer at frequencies as high as 600 megacycles. Outline 10, OUTLINES SECTION. Tube requires miniature seven-contact socket and may be mounted in any position. For heater and cathode considerations, refer to type 6AQ5.

HEATER VOLTAGE (AC/DC).....	6.3	volts
HEATER CURRENT.....	0.45	ampere
DIRECT INTERELECTRODE CAPACITANCE: *		
Grid to Plate.....	1.5	μμf
Grid to Cathode.....	2.0	μμf
Plate to Cathode.....	0.4	μμf

* No external shield. Approximate values for each unit.

Maximum Ratings:

CLASS A₁ AF AMPLIFIER

PLATE VOLTAGE.....	300 <i>max</i>	volts
PLATE DISSIPATION (PER UNIT).....	1.5 <i>max</i>	watts
PEAK HEATER-CATHODE VOLTAGE:		
Heater negative with respect to cathode.....	90 <i>max</i>	volts
Heater positive with respect to cathode.....	90 <i>max</i>	volts

Typical Operation (Each Unit):

Plate Voltage.....	100	volts
Cathode-Bias Resistor**.....	50†	ohms
Amplification Factor.....	38	
Plate Resistance.....	7100	ohms
Transconductance.....	5300	μmhos
Plate Current.....	8.5	ma

** Under maximum rated conditions, the resistance in the grid circuit should not exceed 0.5 megohm with cathode bias. Operation with fixed bias is not recommended.

† Value is for both units operating at the specified conditions.

RF POWER AMPLIFIER AND OSCILLATOR—Class C Telegraphy

Values are for both units, unless otherwise specified.

Maximum Ratings:

DC PLATE VOLTAGE.....	300 <i>max</i>	volts
DC GRID VOLTAGE.....	-40 <i>max</i>	volts
DC PLATE CURRENT (PER UNIT).....	15 <i>max</i>	ma
DC GRID CURRENT (PER UNIT).....	8 <i>max</i>	ma
DC PLATE INPUT (PER UNIT).....	4.5 <i>max</i>	watts
PLATE DISSIPATION (PER UNIT).....	1.5 <i>max</i>	watts
PEAK HEATER-CATHODE VOLTAGE:		
Heater negative with respect to cathode.....	90 <i>max</i>	volts
Heater positive with respect to cathode.....	90 <i>max</i>	volts

Typical Operation:‡

DC Plate Voltage.....	150	volts
DC Grid Voltage°.....	-10	volts
DC Plate Current.....	30	ma
DC Grid Current (Approx.).....	16	ma
Driving Power (Approx.).....	0.35	watt
Power Output (Approx.).....	3.5	watts

‡ At moderate frequencies in push-pull. Key-down conditions without modulation. At 250 Mc, approximately 1.0 watt can be obtained when the 6J6 is used as a push-pull oscillator with a plate voltage of 150 volts, with maximum rated plate dissipation, and with a grid resistor of 2000 ohms common to both units.

° Obtained by grid resistor (625 ohms), cathode resistor (220 ohms), or fixed supply.

AVERAGE PLATE CHARACTERISTICS
FOR EACH UNIT

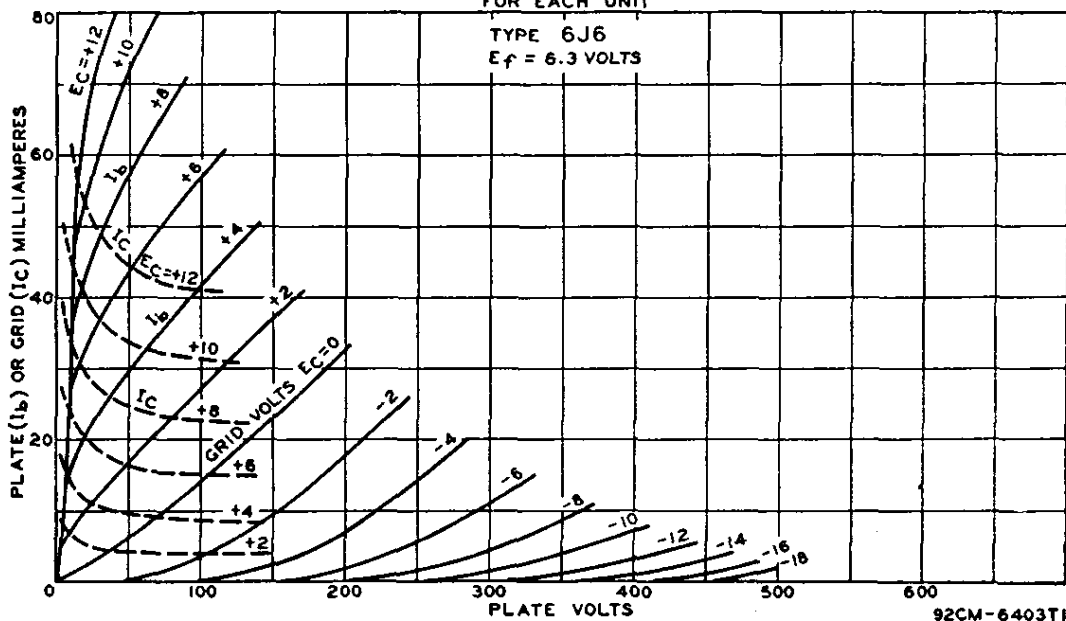

6J7 6J7-G 6J7-GT

SHARP-CUTOFF PENTODE

Metal type 6J7 and glass-octal types 6J7-G and 6J7-GT are used as biased detectors or high-gain audio amplifiers in radio receivers. Outlines 4, 26, and 18, respectively, OUTLINES

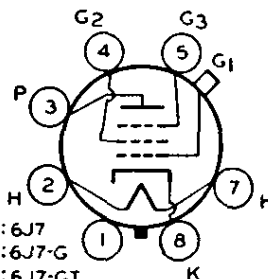

SECTION. All types require octal socket and may be mounted in any position. For typical operation as resistance-coupled amplifiers, refer to Charts 11 and 14, RESISTANCE-COUPLED AMPLIFIER SECTION. For heater and cathode considerations, refer to type 6AT6.

HEATER VOLTAGE (AC/DC)	6.3	volts
HEATER CURRENT	0.3	ampere

Maximum Ratings: CLASS A₁ AMPLIFIER (Pentode Connection)

PLATE VOLTAGE	300 max	volts
GRID-NO.2 (SCREEN) VOLTAGE	125 max	volts
GRID-NO.2 SUPPLY VOLTAGE	300 max	volts
GRID-NO.1 (CONTROL-GRID) VOLTAGE	0 min	volts
PLATE DISSIPATION	0.75 max	watt
GRID-NO.2 DISSIPATION	0.10 max	watt
PEAK HEATER-CATHODE VOLTAGE:		
Heater negative with respect to cathode	90 max	volts
Heater positive with respect to cathode	90 max	volts

Typical Operation:

Plate Voltage	100	250	volts
Grid No.3 (Suppressor)	Connected to cathode at socket		
Grid-No.2 Voltage	100	100	volts
Grid-No.1 Voltage*	-3	-3	volts
Plate Resistance	1.0	+	megohm
Transconductance	1185	1225	μmhos
Grid Bias (Approx.) for cathode-current cutoff	-7	-7	volts
Plate Current	2	2	ma
Grid-No.2 Current	0.5	0.5	ma

Maximum Ratings: CLASS A₁ AMPLIFIER (Triode Connection)^o

PLATE VOLTAGE	250 max	volts
GRID-NO.1 VOLTAGE	0 min	volts
PLATE AND GRID-NO.2 DISSIPATION (TOTAL)	1.75 max	watts

Typical Operation:

Plate Voltage.....	180	250	volts
Grid-No.1 Voltage*.....	-5.3	-8	volts
Amplification Factor.....	20	20	
Plate Resistance.....	11000	10500	ohms
Transconductance.....	1800	1900	μmhos
Plate Current.....	5.3	6.5	ma

* DC resistance in grid circuit should not exceed 1.0 megohm.

+ Greater than 1.0 megohm.

° Grids No.2 and No.3 connected to plate.

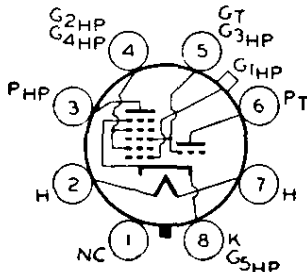

TRIODE—HEPTODE CONVERTER

Glass octal type used as a combined triode oscillator and heptode mixer in radio receivers. Outline 26, OUTLINES SECTION. Tube requires octal socket. Heater volts (ac/dc), 6.3; amperes, 0.3. Typical operation—Heptode unit: plate volts, 250 (300 max); grids-No.2-and-No.4 volts, 100 max; grid-No.1 volts, -3; plate resistance, 4 megohms; conversion transconductance, 290 μmhos; plate ma., 1.3; grids-No.2-and-No.4 ma., 3.5. Triode unit: plate volts, 250 max (applied through 20000-ohm dropping resistor); grid resistor, 50000 ohms; plate ma., 5.8. This type is used principally for renewal purposes.

6J8-G

HIGH-MU TRIODE

Glass octal type used as voltage amplifier in radio equipment. Outline 18, OUTLINES SECTION. Tube requires octal socket. Heater volts (ac/dc), 6.3; amperes, 0.3. Characteristics as class A₁ amplifier: plate volts, 250 max; grid volts, -3; amplification factor, 70; plate resistance, 50000 ohms; transconductance, 1400 μmhos; plate ma., 1.1. This type is used principally for renewal purposes.

6K5-GT

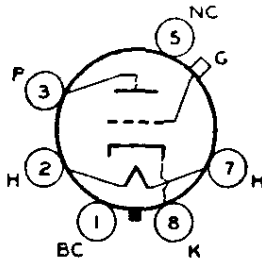

POWER PENTODE

Glass octal type used in output stage of radio receivers. It is capable of delivering moderate power output with relatively small input voltage. Tube may be used singly or in push-pull.

6K6-GT

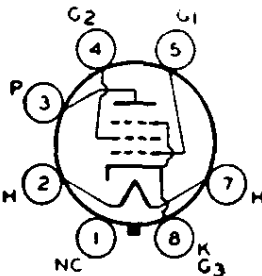

HEATER VOLTAGE (AC/DC).....	6.3		volts
HEATER CURRENT.....	0.4		ampere
DIRECT INTERELECTRODE CAPACITANCES (Approx. With no external shield):			
Grid No.1 to Plate.....	0.5		μμf
Input.....	5.5		μμf
Output.....	6.0		μμf

SINGLE-TUBE CLASS A₁ AMPLIFIER

Maximum Ratings:			
PLATE VOLTAGE.....	315 max		volts
GRID-NO.2 (SCREEN) VOLTAGE.....	285 max		volts
PLATE DISSIPATION.....	8.5 max		watts
GRID-NO.2 DISSIPATION.....	2.8 max		watts
PEAK HEATER-CATHODE VOLTAGE:			
Heater negative with respect to cathode.....	90 max		volts
Heater positive with respect to cathode.....	90 max		volts

Typical Operation:

Plate Voltage.....	100	250	315	volts
Grid-No.2 Voltage.....	100	250	250	volts
Grid-No.1 (Control-Grid) Voltage.....	-7	-18	-21	volts
Peak AF Grid-No.1 Voltage.....	7	18	21	volts
Zero-Signal Plate Current.....	9	32	25.5	ma
Maximum-Signal Plate Current.....	9.5	33	28	ma
Zero-Signal Grid-No.2 Current.....	1.6	5.5	4.0	ma
Maximum-Signal Grid-No.2 Current.....	3	10	9	ma
Plate Resistance (Approx.).....	104000	68000	75000	ohms
Transconductance.....	1500	2300	2100	μmhos
Load Resistance.....	12000	7600	9000	ohms
Total Harmonic Distortion.....	11	11	15	per cent
Maximum-Signal Power Output.....	0.35	3.4	4.5	watts

Maximum Ratings: PUSH-PULL CLASS A₁ AMPLIFIER
 (Same as for single-tube class A₁ amplifier.)

Typical Operation (Values are for two tubes):	<i>Fixed Bias</i>	<i>Cathode Bias</i>	
Plate Voltage.....	285	285	volts
Grid-No.2 Voltage.....	285	285	volts
Grid-No.1 (Control-Grid) Voltage.....	-25.5	-	volts
Cathode Resistor.....	-	400	ohms
Peak AF Grid-No.1-to-Grid-No.1 Voltage.....	51	51	volts
Zero-Signal Plate Current.....	55	55	ma
Maximum-Signal Plate Current.....	72	61	ma
Zero-Signal Grid-No.2 Current.....	9	9	ma
Maximum-Signal Grid-No.2 Current.....	17	13	ma
Effective Load Resistance (Plate-to-plate).....	12000	12000	ohms
Total Harmonic Distortion.....	6	4	per cent
Maximum-Signal Power Output.....	10.5	9.8	watts

INSTALLATION AND APPLICATION

Tube requires octal socket and may be mounted in any position. Outline 17, OUTLINES SECTION. It is especially important that this tube, like other power-handling tubes, should be adequately ventilated.

Any conventional type of input coupling may be used provided the resistance added to the grid circuit by this device is not too high. Transformer- or impedance-coupling devices are recommended. When the grid circuit has a resistance not higher than 0.1 megohm, fixed bias may be used; for higher values, cathode bias is required. With cathode bias, the grid circuit may have a resistance as high as but not greater than 1.0 megohm, provided the heater voltage does not rise more than 10% above the rated value under any condition of operation.

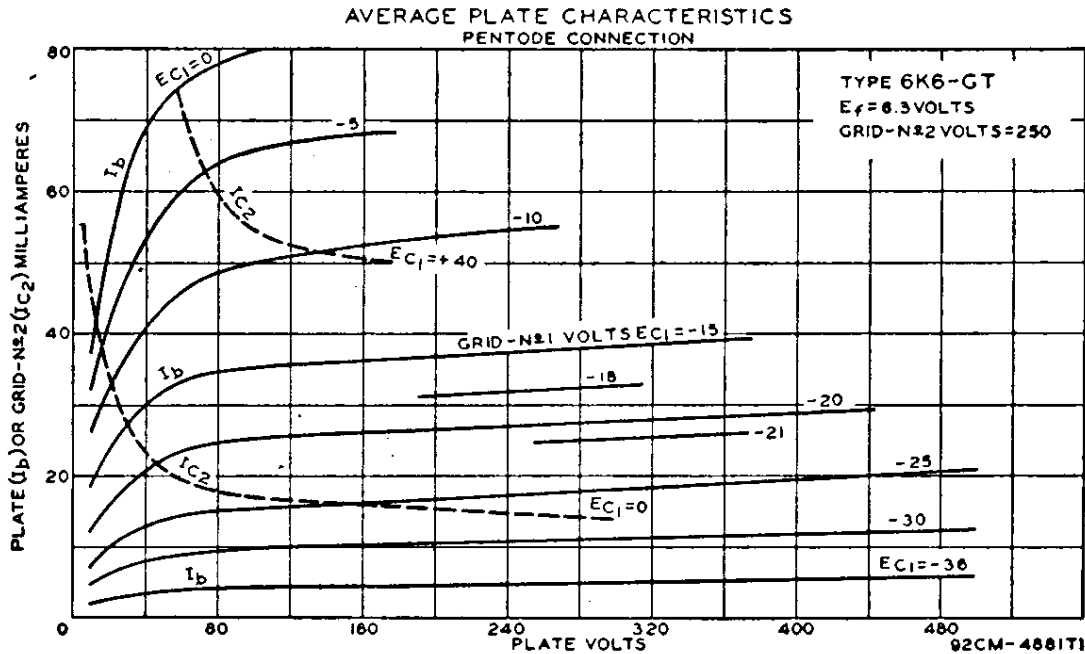

6K7
6K7-G
6K7-GT

REMOTE-CUTOFF PENTODE

Metal type 6K7 and glass-octal types 6K7-G and 6K7-GT used in rf and if stages of radio receivers, particularly in those employing avc. Outlines 4, 26, and 18, respectively, OUT-

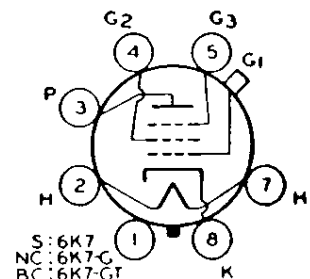

LINES SECTION. These tubes require octal socket and may be mounted in any position. For voltage supplies and application, refer to type 6SK7. For heater and cathode considerations, refer to type 6AT6.

HEATER VOLTAGE (AC/DC).....	6.3	volts
HEATER CURRENT.....	0.3	ampere

Maximum Ratings:

CLASS A₁ AMPLIFIER

PLATE VOLTAGE.....	300 <i>max</i>	volts
GRID-NO.2 (SCREEN) VOLTAGE.....	125 <i>max</i>	volts
GRID-NO.2 SUPPLY VOLTAGE.....	300 <i>max</i>	volts
GRID-NO.1 (CONTROL-GRID) VOLTAGE.....	0 <i>min</i>	volts
PLATE DISSIPATION.....	2.75 <i>max</i>	watts
GRID-NO.2 DISSIPATION.....	0.35 <i>max</i>	watt
PEAK HEATER-CATHODE VOLTAGE:		
Heater negative with respect to cathode.....	90 <i>max</i>	volts
Heater positive with respect to cathode.....	90 <i>max</i>	volts

Typical Operation:

Plate Voltage.....	100	250	250	volts
Grid No.3 (Suppressor).....	Connected to cathode at socket			
Grid-No.2 Voltage.....	100	100	125	volts
Grid-No.1 Voltage.....	-1	-3	-3	volts
Plate Resistance (Approx.).....	0.15	0.8	0.6	megohm
Transconductance.....	1650	1450	1650	μmhos
Grid Bias for transconductance of approx. 2 μmhos.....	-38.5	-42.5	-52.5	volts
Plate Current.....	9.5	7.0	10.5	ma
Grid-No.2 Current.....	2.7	1.7	2.6	ma

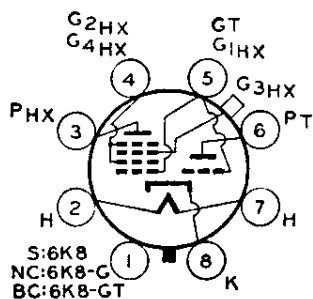

TRIODE-HEXODE CONVERTER

Metal type 6K8 and glass-octal types 6K8-G and 6K8-GT used as combined triode oscillator and hexode mixer in radio receivers. Type 6K8, Outline 5, type 6K8-G, Outline 25,

6K8 6K8-G 6K8-GT

OUTLINES SECTION. Type 6K8-GT is a **DISCONTINUED** type listed for reference only. Tubes require octal socket and may be mounted in any position. For heater and cathode considerations, refer to type 6AT6. For application, refer to **Frequency Conversion** in **ELECTRON TUBE APPLICATIONS SECTION.**

HEATER VOLTAGE (AC/DC).....	6.3	volts
HEATER CURRENT.....	0.3	ampere

Maximum Ratings:

CONVERTER SERVICE

HEXODE PLATE VOLTAGE.....	300 <i>max</i>	volts
HEXODE GRIDS-NO.2-AND-NO.4 (SCREEN) VOLTAGE.....	150 <i>max</i>	volts
HEXODE GRIDS-NO.2-AND-NO.4 SUPPLY VOLTAGE.....	300 <i>max</i>	volts
HEXODE GRID-NO.3 (CONTROL-GRID) VOLTAGE.....	0 <i>min</i>	volts
TRIODE PLATE VOLTAGE.....	125 <i>max</i>	volts
HEXODE PLATE DISSIPATION.....	0.75 <i>max</i>	watt
HEXODE GRIDS-NO.2-AND-NO.4 DISSIPATION.....	0.7 <i>max</i>	watt
TRIODE PLATE DISSIPATION.....	0.75 <i>max</i>	watt
TOTAL CATHODE CURRENT.....	16 <i>max</i>	ma
PEAK HEATER-CATHODE VOLTAGE:		
Heater negative with respect to cathode.....	90 <i>max</i>	volts
Heater positive with respect to cathode.....	90 <i>max</i>	volts

Typical Operation:

Hexode Plate Voltage.....	100	250	volts
Hexode Grids-No.2-and-No.4 Voltage.....	100	100	volts
Hexode Grid-No.3 Voltage.....	-3	-3	volts
Triode Plate Voltage.....	100	100	volts
Triode Grid Resistor.....	50000	50000	ohms
Hexode Plate Resistance (Approx.).....	0.4	0.6	megohm
Conversion Transconductance.....	325	350	μmhos
Hexode Grid-No.3 Voltage (Approx.) for conversion transconductance of 2 μmhos.....	-30	-30	volts
Hexode Plate Current.....	2.3	2.5	ma
Hexode Grids-No.2-and-No.4 Current.....	6.2	6.0	ma
Triode Plate Current.....	3.8	3.8	ma
Triode Grid and Hexode Grid-No.1 Current.....	0.15	0.15	ma
Total Cathode Current.....	12.5	12.5	ma

The transconductance of the triode section, not oscillating, of the 6K8 is approximately 3000 μmhos when the triode plate voltage is 100 volts, and the triode grid voltage is 0 volts.

MEDIUM-MU TRIODE

6L5-G

Glass octal type used as detector, amplifier, or oscillator in radio receivers. Outline 24, OUTLINES SECTION. Heater volts (ac/dc), 6.3; amperes, 0.15. Typical operation and characteristics: plate volts, 250 *max*; grid volts, -9; plate ma., 8; plate resistance, 9000 ohms; amplification factor, 17; transconductance, 1900 μ mhos; grid-bias volts for cathode-current cutoff, -20.

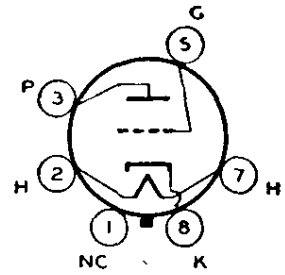

As a class A₁ amplifier, the 6L5-G may be operated in resistance-coupled circuits as shown in Chart 15, RESISTANCE-COUPLED AMPLIFIER SECTION. This type is used principally for renewal purposes.

BEAM POWER AMPLIFIER

6L6
6L6-G

Metal type 6L6 and glass-octal type 6L6-G are used in output stage of radio receivers and amplifiers, especially those designed to have ample reserve of power-delivering ability.

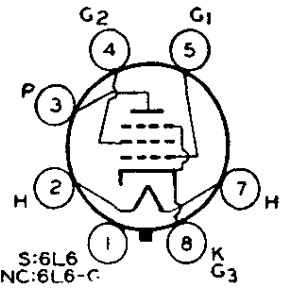

These types provide high power output, sensitivity, and high efficiency. Power output at all levels has low third and negligible higher-order harmonics. For discussion of beam power amplifier considerations, refer to ELECTRONS, ELECTRODES, AND ELECTRON TUBES SECTION.

HEATER VOLTAGE (AC/DC)		6.3	volts
HEATER CURRENT		0.9	ampere
DIRECT INTERELECTRODE CAPACITANCES (Approx.):	<i>6L6</i>	<i>6L6-G</i>	
Grid No.1 to Plate	0.4	0.9	μ mf
Input	10	11.5	μ mf
Output	12	9.5	μ mf

Maximum Ratings: SINGLE-TUBE CLASS A₁ AMPLIFIER

PLATE VOLTAGE	360 <i>max</i>	volts
GRID-NO.2 (SCREEN) VOLTAGE	270 <i>max</i>	volts
PLATE DISSIPATION	19 <i>max</i>	watts
GRID-NO.2 DISSIPATION	2.5 <i>max</i>	watts
PEAK HEATER-CATHODE VOLTAGE:		
Heater negative with respect to cathode	180 <i>max</i>	volts
Heater positive with respect to cathode	180 <i>max</i>	volts

Typical Operation:

	<i>Fixed Bias</i>		<i>Cathode Bias</i>		
Plate Voltage	250	350	250	300	volts
Grid-No.2 Voltage	250	250	250	200	volts
Grid-No.1 (Control-Grid) Voltage	-14	-18	-	-	volts
Cathode Resistor	-	-	170	220	ohms
Peak AF Grid-No.1 Voltage	14	18	14	12.5	volts
Zero-Signal Plate Current	72	54	75	51	ma
Maximum-Signal Plate Current	79	66	78	54.5	ma
Zero-Signal Grid-No.2 Current	5	2.5	5.4	3	ma
Maximum-Signal Grid-No.2 Current	7.3	7	7.2	4.6	ma
Plate Resistance	22500	33000	-	-	ohms
Transconductance	6000	5200	-	-	μ mhos
Load Resistance	2500	4200	2500	4500	ohms
Total Harmonic Distortion	10	15	10	11	per cent
Maximum-Signal Power Output	6.5	10.8	6.5	6.5	watts

SINGLE-TUBE CLASS A₁ AMPLIFIER (Triode Connection)†

Maximum Ratings:

PLATE VOLTAGE	275 <i>max</i>	volts
PLATE AND GRID-NO.2 DISSIPATION (TOTAL)	12.5 <i>max</i>	watts
PEAK HEATER-CATHODE VOLTAGE:		
Heater negative with respect to cathode	180 <i>max</i>	volts
Heater positive with respect to cathode	180 <i>max</i>	volts

RCA RECEIVING TUBE MANUAL

Typical Operation:

	<i>Fixed Bias</i>	<i>Cathode Bias</i>	
Plate Voltage	250	250	volts
Grid Voltage	-20	-	volts
Cathode Resistor	-	490	ohms
Peak AF Grid Voltage	20	20	volts
Zero-Signal Plate Current	40	40	ma
Maximum-Signal Plate Current	44	42	ma
Plate Resistance	1700	-	ohms
Amplification Factor	8	-	
Transconductance	4700	-	μmhos
Load Resistance	5000	6000	ohms
Total Harmonic Distortion	5	6	per cent
Maximum-Signal Power Output	1.4	1.3	watts

† Grid No.2 connected to plate.

Maximum Ratings: PUSH-PULL CLASS A₁ AMPLIFIER

(Same as for single-tube class A₁ amplifier)

Typical Operation (Values are for two tubes)

	<i>Fixed Bias</i>		<i>Cathode Bias</i>	
Plate Voltage	250	270	270	volts
Grid-No.2 Voltage	250	270	270	volts
Grid-No.1 (Control-Grid) Voltage	-16	-17.5	-	volts
Cathode Resistor	-	-	125	ohms
Peak AF Grid-No.1-to-Grid-No.1 Voltage	32	35	40	volts
Zero-Signal Plate Current	120	134	134	ma
Maximum-Signal Plate Current	140	155	145	ma
Zero-Signal Grid-No.2 Current	10	11	11	ma
Maximum-Signal Grid-No.2 Current	16	17	17	ma
Plate Resistance	24500	23500	-	ohms
Transconductance	5500	5700	-	μmhos
Effective Load Resistance (Plate-to-plate)	5000	5000	5000	ohms
Total Harmonic Distortion	2	2	2	per cent
Maximum-Signal Power Output	14.5	17.5	18.5	watts

Maximum Ratings: PUSH-PULL CLASS AB₁ AMPLIFIER

(Same as for single-tube class A₁ amplifier)

Typical Operation (Values are for two tubes):

	<i>Fixed Bias</i>		<i>Cathode Bias</i>	
Plate Voltage	360	360	360	volts
Grid-No.2 Voltage	270	270	270	volts
Grid-No.1 (Control-Grid) Voltage	-22.5	-22.5	-	volts
Cathode Resistor	-	-	250	ohms
Peak AF Grid-No.1-to-Grid-No.1 Voltage	45	45	57	volts
Zero-Signal Plate Current	88	88	88	ma
Maximum-Signal Plate Current	132	140	100	ma
Zero-Signal Grid-No.2 Current	5	5	5	ma
Maximum-Signal Grid-No.2 Current	15	11	17	ma
Effective Load Resistance (Plate-to-plate)	6600	3800	9000	ohms
Total Harmonic Distortion	2	2	4	per cent
Maximum-Signal Power Output	26.5	18	24.5	watts

Maximum Ratings: PUSH-PULL CLASS AB₂ AMPLIFIER

(Same as for single-tube class A₁ amplifier)

Typical Operation (Values are for two tubes):

	<i>Fixed Bias</i>		
Plate Voltage	360	360	volts
Grid-No.2 Voltage	225	270	volts
Grid-No.1 (Control-Grid) Voltage	-18	-22.5	volts
Peak AF Grid-No.1-to-Grid-No.1 Voltage	52	72	volts
Zero-Signal Plate Current	78	88	ma
Maximum-Signal Plate Current	142	205	ma
Zero-Signal Grid-No.2 Current	3.5	5	ma
Maximum-Signal Grid-No.2 Current	11	16	ma
Effective Load Resistance (Plate-to-plate)	6000	3800	ohms
Peak Grid-Input Power	140	270	mw
Total Harmonic Distortion	2	2	per cent
Maximum-Signal Power Output	31	47	watts

INSTALLATION AND APPLICATION

Types 6L6 and 6L6-G require an octal socket and may be mounted in any position. Outlines 7 and 33, respectively, OUTLINES SECTION. It is especially important that these tubes, like other power-handling tubes, should be adequately ventilated.

The heater is designed to operate at 6.3 volts. The transformer supplying this voltage should be designed to operate the heater at this recommended value for full-load operating conditions at average line voltage. Under the maximum screen- and plate-dissipation conditions, the heater voltage should never fluctuate so that it exceeds 7.0 volts. For cathode connection, refer to type 6AQ5.

In all services, precautions should be taken to insure that the dissipation rating is not exceeded with expected line-voltage variations, especially in the cases of fixed-bias operation. When the push-pull connection is used, fixed-bias values up to 10% of each typical grid-No.2 voltage can be used without increasing distortion.

As class A_1 power amplifiers, the 6L6 and 6L6-G may be operated as shown in the tabulated data. The values cover cathode- and fixed-bias operation for both types where used as beam power tubes as well as where they are connected as triodes and have been determined on the basis that no grid current flows during any part of the input-signal swing. The second harmonics can easily be eliminated by the use of push-pull circuits. In single-tube amplifiers with resistance-coupled input, the second harmonics can be minimized by generating out-of-phase second harmonics in the pre-amplifier.

As push-pull class AB_1 power amplifiers, the 6L6 and 6L6-G may be operated as shown in the tabulated data. The values shown cover cathode- and fixed-bias operation and have been determined on the basis that no grid current flows during any part of the input-signal swing.

The type of input coupling used in class A_1 and class AB_1 service should not introduce too much resistance in the grid circuit. Transformer- or impedance-coupling devices are recommended. When the grid circuit has a resistance not higher than 0.1 megohm, fixed bias may be used; for higher values, cathode bias is required. With cathode bias the grid circuit may have a resistance as high as, but not greater than, 0.5 megohm provided the heater voltage is not allowed to rise more than 10% above the rated value under any condition of operation.

As push-pull class AB_1 power amplifiers, the 6L6 and the 6L6-G may be operated as shown in the tabulated data. The values cover operation with fixed bias and have been determined on the basis that some grid current flows during the most positive swing of the input signal.

Refer to CIRCUIT SECTION for circuits employing the 6L6 or 6L6-G, and to the ELECTRON TUBE APPLICATIONS SECTION for discussion of inverse-feedback arrangements.

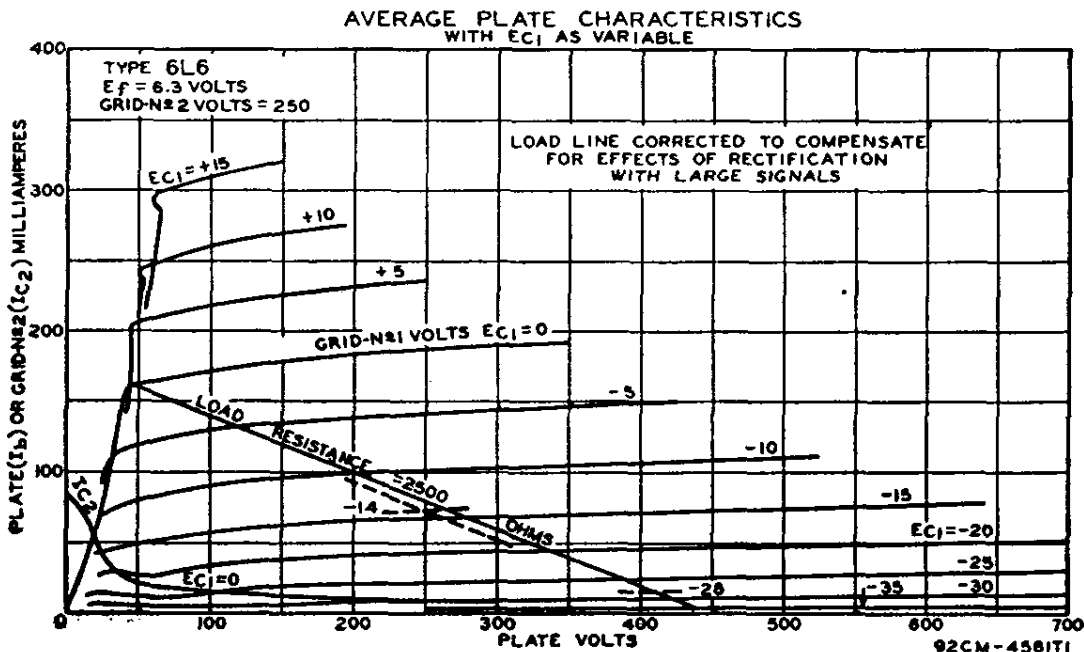

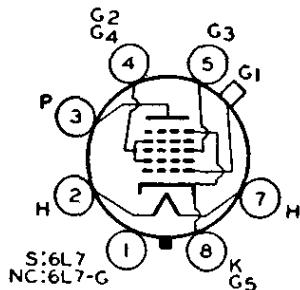

PENTAGRID MIXER

Metal type 6L7 and glass-octal type 6L7-G are used as mixers in superheterodyne circuits having a separate oscillator stage as well as in other applications where dual control is desirable in a single stage. The two separate control grids are shielded from each other and the coupling effects between oscillator and signal circuits are very small. For additional information, refer to Frequency Conversion, ELECTRON TUBE APPLICATIONS SECTION. Outlines 4 and 26, respectively, OUTLINES SECTION. Heater volts (ac/dc), 6.3; amperes, 0.3. Maximum ratings as mixer: plate volts, 300; grids-No.2-and-No.4 volts, 150; plate dissipation, 1.0 watt; grids-No.2-and-No.4 dissipation, 1.5 watts. Typical operation as mixer (values recommended for all-wave receivers): plate volts, 250; grids-No.2-and-No.4 volts, 150; grid-No.1 (signal-grid) volts, -6 min; grid-No.3 (oscillator-grid) volts*, -15; peak oscillator volts applied to grid No.3, 18 min; plate ma., 3.3; grids-No.2-and-No.4 ma., 9.2; plate resistance, greater than 1 megohm; conversion transconductance, 350 μ mhos; grid-No.1 volts for 5 μ mhos conversion transconductance, -45.

**6L7
6L7-G**

* The dc resistance in the grid-No.3 circuit should be limited to 50000 ohms.

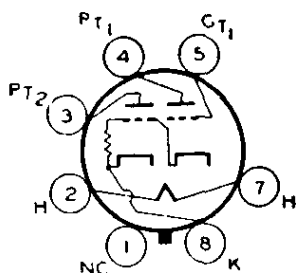

DIRECT-COUPLED POWER TRIODE

Glass octal type used as class A₁ power amplifier. Outline 28, OUTLINES SECTION. Heater volts (ac/dc), 6.3; amperes, 0.8. For electrical characteristics, refer to type 6B5. Type 6N6-G is used principally for renewal purposes.

6N6-G

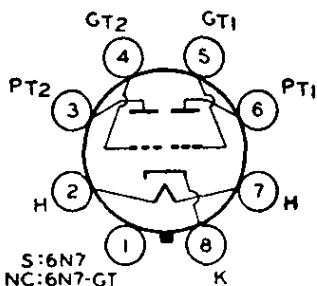

HIGH-MU TWIN POWER TRIODE

Metal type 6N7 and glass-octal type 6N7-GT used in output stage of radio receivers as class B power amplifier or with units in parallel as a class A₁ amplifier to drive a 6N7 or 6N7-GT

**6N7
6N7-GT**

as a class B amplifier. Outlines 6 and 17, respectively, OUTLINES SECTION. Tubes require octal socket and may be mounted in any position. For typical operation as a resistance-coupled amplifier, refer to Chart 6, RESISTANCE-COUPLED AMPLIFIER SECTION. For class B amplifier considerations, refer to ELECTRON TUBE APPLICATIONS SECTION.

HEATER VOLTAGE (AC/DC).....	6.3	volts
HEATER CURRENT.....	0.8	ampere

CLASS B POWER AMPLIFIER

Values are for two tubes, unless otherwise specified.

Maximum Ratings:

PLATE VOLTAGE.....	300 max	volts
PEAK PLATE CURRENT (Each Unit).....	125 max	ma
AVERAGE PLATE DISSIPATION (Each Unit).....	5.5 max	watts
PEAK HEATER-CATHODE VOLTAGE:		
Heater negative with respect to cathode.....	90 max	volts
Heater positive with respect to cathode.....	90 max	volts

Typical Operation:

Plate-Supply Impedance.....	0	1000	ohms
Effective Grid-Circuit Impedance.....	0	516**	ohms
Plate Voltage.....	300	300	volts
Grid Voltage.....	0	0	volts
Peak AF Grid-to-Grid Voltage.....	58	82	volts
Zero-Signal DC Plate Current.....	35	35	ma
Maximum-Signal DC Plate Current.....	70	70	ma
Peak Grid Current (Each Unit).....	20	22	ma
Effective Load Resistance (Plate-to-Plate).....	8000	8000	ohms
Total Harmonic Distortion.....	4	8	per cent

Third Harmonic Distortion.....	3.5	7.5	per cent
Fifth Harmonic Distortion.....	1.5	2.5	per cent
Maximum-Signal Power Output.....	10	10	watts

** At 400 cycles for class B stage in which the effective resistance per grid circuit is 500 ohms, and the leakage reactance of the coupling transformer is 50 millihenries. The driver stage should be capable of supplying the grids of the class B stage with the specified values at low distortion.

CLASS A₁ AMPLIFIER

Both grids connected together at socket; likewise, both plates.

Maximum Ratings:

PLATE VOLTAGE.....	300 <i>max</i>	volts
PLATE DISSIPATION (per plate).....	1.0 <i>max</i>	watt
PEAK HEATER-CATHODE VOLTAGE:		
Heater negative with respect to cathode.....	90 <i>max</i>	volts
Heater positive with respect to cathode.....	90 <i>max</i>	volts

Typical Operation:

Plate Voltage.....	250	300	volts
Grid Voltage.....	-5	-6	volts
Amplification Factor.....	35	35	
Plate Resistance.....	11300	11000	ohms
Transconductance.....	3100	3200	μ mhos
Plate Current.....	6	7	ma

Plate Load—Depends largely on the design factors of the class B amplifier. In general, the load will be between 20000 and 40000 ohms.

Power Output—Under maximum voltage conditions, upwards of 400 milliwatts can be obtained.

MEDIUM-MU TRIODE

6P5-GT

Glass octal type used as detector, amplifier, or oscillator in radio receivers. Outline 17, OUTLINES SECTION. Tube requires octal socket. Heater volts (ac/dc), 6.3; amperes, 0.3. Except for interelectrode capacitances, this type is identical electrically with type 76. Type 6P5-GT is used principally for renewal purposes.

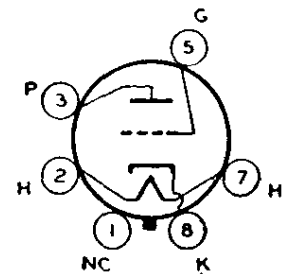

TRIODE—PENTODE

6P7-G

Glass octal type used as an amplifier. Outline 26, OUTLINES SECTION. Heater volts (ac/dc), 6.3; amperes, 0.3. Except for interelectrode capacitances, this type is identical electrically with type 6P7. Type 6P7-G is a DISCONTINUED type listed for reference only.

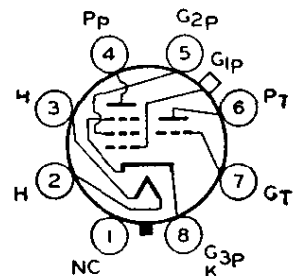

6Q7 6Q7-G 6Q7-GT

TWIN DIODE—HIGH-MU TRIODE

Metal type 6Q7 and glass-octal types 6Q7-G and 6Q7-GT used as a combined detector, amplifier, and avc tube in radio receivers. Outlines 4, 26, and 18, respectively, OUTLINES

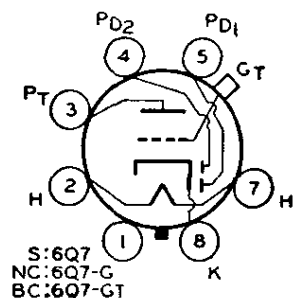

SECTION. Tubes require octal socket and may be mounted in any position. Heater volts (ac/dc), 6.3; amperes, 0.3. For heater and cathode considerations, refer to type 6AT6. These types are similar electrically in most respects to types 6SQ7 and 6AT6. Maximum ratings and typical operation of the triode unit as a class A₁ amplifier are the same as those for type 6AT6 except that with a plate voltage of 100 volts, the transconductance is 1200 μ mhos and the plate resistance 58000 ohms. The triode unit is recommended for use only in resistance-coupled circuits; refer to Chart 7, RESISTANCE-COUPLED AMPLIFIER SECTION. For grid-bias considerations applying to the triode unit, refer to type 6AT6. For diode curves, refer to type 6SQ7.

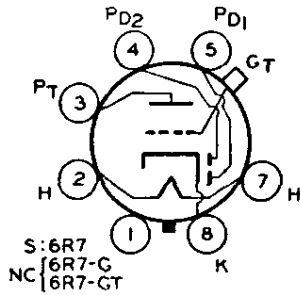

TWIN DIODE—MEDIUM-MU TRIODE

Metal type 6R7 and glass-octal types 6R7-G and 6R7-GT used as combined detector, amplifier, and avc tubes. Outlines 4, 26, and 16, respectively, OUTLINES SECTION. Tubes require octal sockets. Within their maximum ratings, these types are identical electrically with type 6BF6 except for capacitances. Maximum ratings of triode unit as class A₁ amplifier:

6R7
6R7-G
6R7-GT

plate volts, 250 *max*; plate dissipation, 2.5 *max* watts. For typical operation as a resistance-coupled amplifier, refer to Chart 9, RESISTANCE-COUPLED AMPLIFIER SECTION. Type 6R7-G is a DISCONTINUED type listed for reference only.

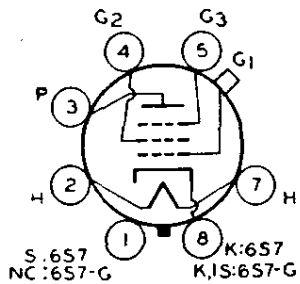

REMOTE-CUTOFF PENTODE

Metal type 6S7 and glass-octal type 6S7-G are used in rf and if stages of automobile receivers employing avc. Outlines 5 and 26, respectively, OUTLINES SECTION. Tubes require octal socket and may be mounted in any position. Heater volts, 6.3; amperes, 0.15. Typical operation and maximum ratings as class A₁ amplifier: plate volts, 250 (300 *max*);

6S7
6S7-G

grid-No.2 volts, 100 *max*; grid-No.1 volts, -3 (0 *min*); grid No.3 connected to cathode at socket; plate ma., 8.5; grid-No.2 ma., 2; plate resistance, 1.0 megohm; transconductance, 1750 μ mhos; grid-No.1 volts for transconductance of 10 μ mhos, -38.5. Plate dissipation, 2.25 *max* watts; grid-No.2 dissipation, 0.25 *max* watt. For typical operation as a resistance-coupled amplifier, refer to Chart 16, RESISTANCE-COUPLED AMPLIFIER SECTION.

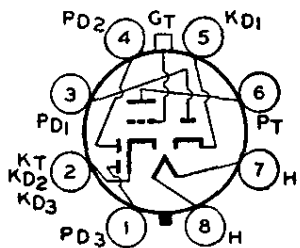

TRIPLE DIODE—TRIODE

Glass octal type used as audio amplifier, AM detector, and FM detector in AM/FM receivers. Diode unit No.2 is used for AM detection, and diode units No.1 and No.3 are used

6S8-GT

for FM detection. The grid of the high-mu triode is brought out to a top cap. Outline is similar to Outline 16, OUTLINES SECTION, except maximum length is 3-5/8 inches and seated height is 3-1/16 inches. Tube may be mounted in any position. For heater and cathode considerations, refer to type 6AT6.

HEATER VOLTAGE (AC/DC).....	6.3	volts
HEATER CURRENT.....	0.3	ampere
DIRECT INTERELECTRODE CAPACITANCES (With external shield):		
Triode Grid to Triode Plate.....	1.2	μ f
Triode Grid to Cathode.....	2.0	μ f
Triode Plate to Cathode.....	5.0	μ f
Diode Plate to Cathode (Approx. for each unit).....	1.0	μ f

Maximum Ratings: TRIODE UNIT AS CLASS A₁ AMPLIFIER

TRIODE PLATE VOLTAGE.....	300 <i>max</i>	volts
TRIODE PLATE DISSIPATION.....	0.5 <i>max</i>	watt
PEAK HEATER-CATHODE VOLTAGE:		
Heater negative with respect to cathode.....	90 <i>max</i>	volts
Heater positive with respect to cathode.....	90 <i>max</i>	volts

Characteristics:

Plate Voltage.....	100	250	volts
Grid Voltage.....	-1	-2	volts
Amplification Factor.....	100	100	
Plate Resistance.....	11000	91000	ohms
Transconductance.....	900	1100	μ mhos
Plate Current.....	0.4	0.9	ma

DIODE UNITS

Diode units No.2 and No.3 and the triode unit have a common cathode. Diode unit No.1 has a separate cathode. For diode operation curves, refer to type 6SQ7.

PENTAGRID CONVERTER

6SA7

Metal type 6SA7 and glass-octal type 6SA7-GT used as converter in superheterodyne circuits. They are similar in performance to type 6BE6. For general discussion of pentagrid types, see **Frequency Conversion in ELECTRON TUBE APPLICATIONS SECTION**. Both tubes have excellent frequency stability.

6SA7-GT

HEATER VOLTAGE (AC/DC) . . . 6.3 volts
HEATER CURRENT 0.3 ampere

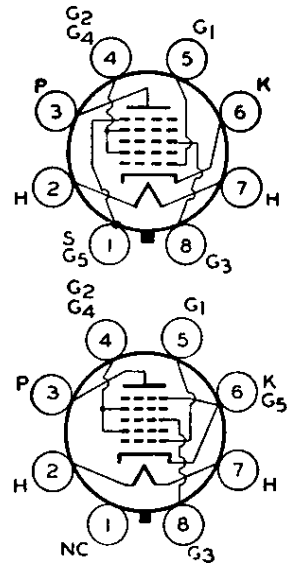

DIRECT INTERELECTRODE CAPACITANCES:

	6SA7	6SA7-GT	
Grid No.3 to All Other Electrodes (RF Input)	9.5*	11**	μf
Plate to All Other Electrodes (Mixer Output)	12*	11**	μf
Grid No.1 to All Other Electrodes (Osc. Input)	7*	8**	μf
Grid No.2 to Plate	0.13 max*	0.5 max**	μf
Grid No.3 to Grid No.1	0.15 max*	0.4 max**	μf
Grid No.1 to Plate	0.06 max*	0.2 max**	μf
Grid No.1 to Shell, Grid No.5, and All Other Electrodes except Cathode	4.4	-	μf
Grid No.1 to All Other Electrodes except Cathode and Grid No.5	-	5	μf
Grid No.1 to Cathode	2.6	-	μf
Grid No.1 to Cathode and Grid No.5	-	3	μf
Cathode to Shell, Grid No.5, and All Other Electrodes except Grid No.1	5	-	μf
Cathode and Grid No.5 to All Other Electrodes except Grid No.1		14	μf

* With shell connected to cathode.
** With external shield connected to cathode.

Maximum Ratings:

CONVERTER SERVICE

PLATE VOLTAGE	300 max	volts
GRIDS-NO.2-AND-NO.4 VOLTAGE	100 max	volts
GRIDS-NO.2-AND-NO.4 SUPPLY VOLTAGE	300 max	volts
GRID-NO.3 VOLTAGE (With self-excitation)	0 min	volts
PLATE DISSIPATION	1.0 max	watt
GRIDS-NO.2-AND-NO.4 DISSIPATION	1.0 max	watt
TOTAL CATHODE CURRENT	14 max	ma
PEAK HEATER-CATHODE VOLTAGE:		
Heater negative with respect to cathode	90 max	volts
Heater positive with respect to cathode	90 max	volts

Typical Operation:

	Self-Excitation†		Separate Excitation		
Plate Voltage	100	250	100	250	volts
Grids-No.2-and-No.4 Voltage	100	100	100	100	volts
Grid-No.3 (Control-Grid) Voltage	0	0	-2	-2	volts
Grid-No.1 Resistor	20000	20000	20000	20000	ohms
Plate Resistance (Approx.)	0.5	1.0	0.5	1.0	megohm
Conversion Transconductance	425	450	425	450	μmhos
Conversion Transconductance (Approx.)+	2	2	2	2	μmhos
Plate Current	3.3	3.5	3.3	3.5	ma
Grids-No.2-and-No.4 Current	8.5	8.5	8.5	8.5	ma
Grid-No.1 Current	0.5	0.5	0.5	0.5	ma
Total Cathode Current	12.3	12.5	12.3	12.5	ma

NOTE: The transconductance between grid No.1 and grids No.2 and No.4 connected to plate (not oscillating) is approximately 4500 μmhos under the following conditions: grids No.1, No.3, and shell at 0 volts; grids No.2 and No.4 and plate at 100 volts.

† Characteristics are approximate only and are shown for a Hartley circuit with a feedback of approximately 2 volts peak in the cathode circuit.

‡ With grid-No.3 bias of -35 volts.

INSTALLATION AND APPLICATION

Types 6SA7 and 6SA7-GT require octal socket and may be mounted in any position. Outlines 3 and 17, respectively, OUTLINES SECTION. For heater and cathode considerations, refer to type 6AT6.

Because of the special structural arrangement of the 6SA7 and 6SA7-GT, a change in signal-grid voltage produces little change in cathode current. Consequently, an rf voltage on the signal grid produces little modulation of the electron current flowing in the cathode circuit. This feature is important because it is desirable that the impedance in the cathode circuit should produce little degeneration or regeneration of the signal-frequency input and intermediate-frequency output. Another important feature is that, because signal-grid voltage has little effect on the space charge near the cathode, changes in avc bias produce little change in oscillator transconductance and in the input capacitance of the No.1 grid. There is, therefore, little detuning of the oscillator by avc bias.

A typical self-excited oscillator circuit for use with the 6SA7 will be similar to that for the 12SA7 in the CIRCUIT SECTION. For operation in frequency bands lower than approximately 6 megacycles, the circuit should generally be adjusted to provide, with recommended values of plate and grids-No.2-and-No.4 voltage, a cathode voltage of approximately 2 volts peak, and an oscillator-grid current of 0.5 milliampere through a grid resistor of 20000 ohms. In the low- and medium-frequency bands, the recommended oscillator conditions can be readily met. However, in the band covering frequencies higher than approximately 6 megacycles, the tank-circuit impedance is generally so low that it is not easy to obtain these oscillator conditions. For optimum performance in this band, it is generally best to adjust the oscillator circuit for maximum conversion gain at the low-frequency end of the band. Maximum conversion gain at this end of the band is usually obtained by adjustment of the oscillator circuit to give a cathode voltage of approximately 2 volts peak and an oscillator-grid current of 0.20 to 0.25 milliampere, with a grid resistor of 20000 ohms.

In the 6SA7 and 6SA7-GT operation characteristics curves with self-excitation, E_k is the voltage across the oscillator-coil section between cathode and ground; E_g is the oscillator voltage between cathode and grid.

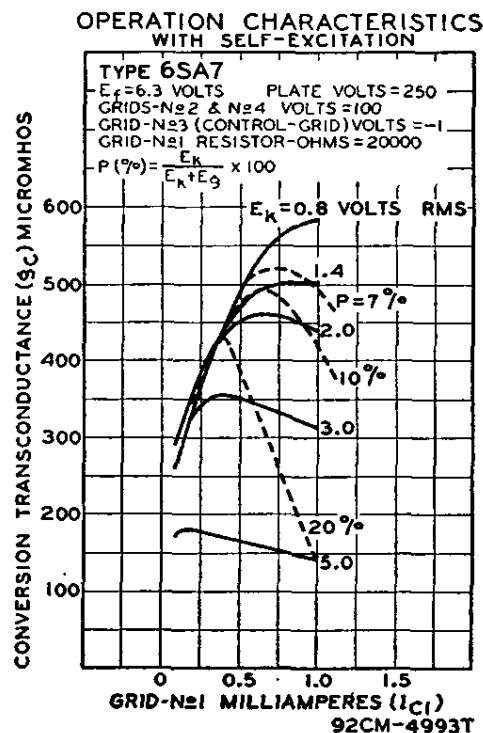
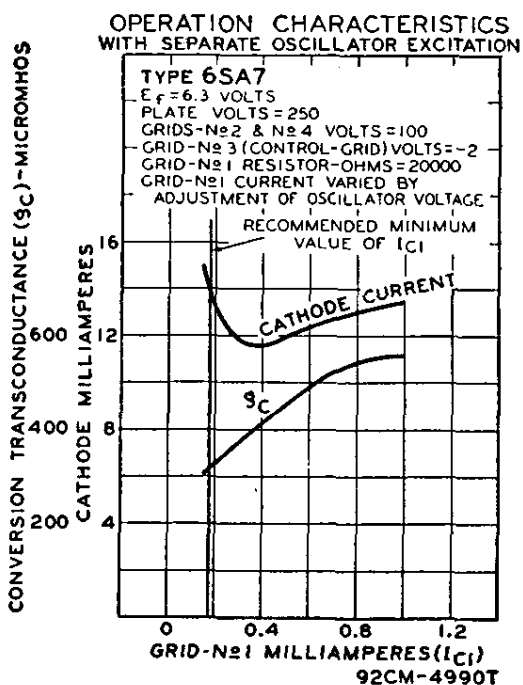

PENTAGRID CONVERTER

6SB7-Y

Metal type used as converter in superheterodyne circuits. Because of its high conversion and oscillator trans-conductance, it is especially useful in FM converter service in the 100-mega-

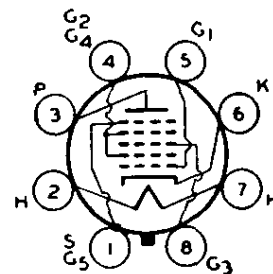

cycle region. The 6SB7-Y has a micanol base which minimizes drift in oscillator frequency during warm-up period. For general discussion of pentagrid types, see **Frequency Conversion** in ELECTRON TUBE APPLICATIONS SECTION. Outline 3, OUTLINES SECTION. Tube requires octal socket and may be mounted in any position. For heater and cathode considerations, refer to type 6AT6.

HEATER VOLTAGE (AC/DC).....	6.3	volts
HEATER CURRENT.....	0.3	ampere

Maximum Ratings:

CONVERTER SERVICE

PLATE VOLTAGE.....	300 max	volts
GRIDS-NO.2-AND-NO.4 VOLTAGE.....	100 max	volts
GRIDS-NO.2-AND-NO.4 SUPPLY VOLTAGE.....	300 max	volts
PLATE DISSIPATION.....	2.0 max	watts
GRIDS-NO.2-AND-NO.4 DISSIPATION.....	1.5 max	watts
TOTAL CATHODE CURRENT.....	22 max	ma
GRID-NO.3 VOLTAGE:		
Negative bias voltage.....	100 max	volts
Positive bias voltage.....	0 max	volts
PEAK HEATER-CATHODE VOLTAGE:		
Heater negative with respect to cathode.....	90 max	volts
Heater positive with respect to cathode.....	90 max	volts

Typical Operation (Separate Excitation):*

Plate Voltage.....	100	250	volts
Grids-No.2-and-No.4 (Screen) Voltage.....	100	100	volts
Grid-No.3 (Control-Grid) Voltage.....	-1.0	-1.0	volt
Grid-No.1 (Oscillator Grid) Resistor.....	20000	20000	ohms
Plate Resistance (Approx.).....	0.5	1.0	megohm
Conversion Transconductance.....	900	950	μmhos
Conversion Transconductance with grid-No.3 bias of -20 volts.....	3.5	3.5	μmhos
Plate Current.....	3.6	3.8	ma
Grids-No.2-and-No.4 Current.....	10.2	10	ma
Grid-No.1 Current.....	0.35	0.35	ma
Total Cathode Current.....	14.2	14.2	ma

* The characteristics shown with separate excitation correspond very closely with those obtained in a self-excited oscillator circuit operating with zero bias.

Typical Operation in FM Band (88-108 Mc):

Plate Voltage.....	250	volts
Grids-No.2-and-No.4 Supply Voltage.....	250	volts
Grids-No.2-and-No.4 Resistor.....	12000	ohms
Grid-No.1 Resistor.....	22000	ohms
Signal Frequency.....	88	Mc
Oscillation Frequency.....	98.7	Mc
Plate Current.....	6.8	ma
Grids-No.2-and-No.4 Current.....	12.6	ma
Grid-No.1 Current.....	0.130	ma

NOTE: The transconductance between grid No.1 and grids No.2 and No.4 connected to plate (not oscillating) is approximately 8000 μmhos under the following conditions: signal applied to grid No.1 at zero bias; grids No.2 and No.4 and plate at 100 volts; grid No.3 grounded. Under the same conditions, the plate current is 32 milliamperes and the amplification factor is 16.5.

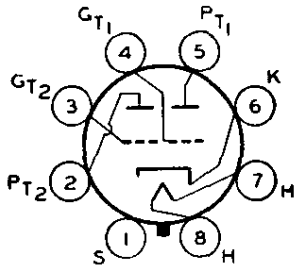

HIGH-MU TWIN TRIODE

6SC7

Metal type used as phase inverter or voltage amplifier in radio equipment. Except for common cathode, each triode is independent of the other. Outline 3, OUTLINES SECTION.

Tube requires octal socket and may be mounted in any position. For heater and cathode considerations, refer to type 6AT6. For typical operation as a resistance-coupled amplifier, refer to Chart 17, RESISTANCE-COUPLED AMPLIFIER SECTION.

HEATER VOLTAGE (AC/DC)	6.3	volts
HEATER CURRENT	0.3	ampere
DIRECT INTERELECTRODE CAPACITANCES (Shell connected to cathode):*		
Grid to Plate	2	μf
Grid to Cathode	2	μf
Plate to Cathode	3	μf

* Approximate values for each unit.

Maximum Ratings:

CLASS A₁ AMPLIFIER

PLATE VOLTAGE	250 max	volts
PEAK HEATER-CATHODE VOLTAGE:		
Heater negative with respect to cathode	90 max	volts
Heater positive with respect to cathode	90 max	volts

Typical Operation (Each Unit):

Plate Voltage	250	volts
Grid Voltage	-2	volts
Amplification Factor	70	
Plate Resistance (Approx.)	53000	ohms
Transconductance (Approx.)	1325	μmhos
Plate Current	2	ma

AVERAGE PLATE CHARACTERISTICS
EACH TRIODE UNIT

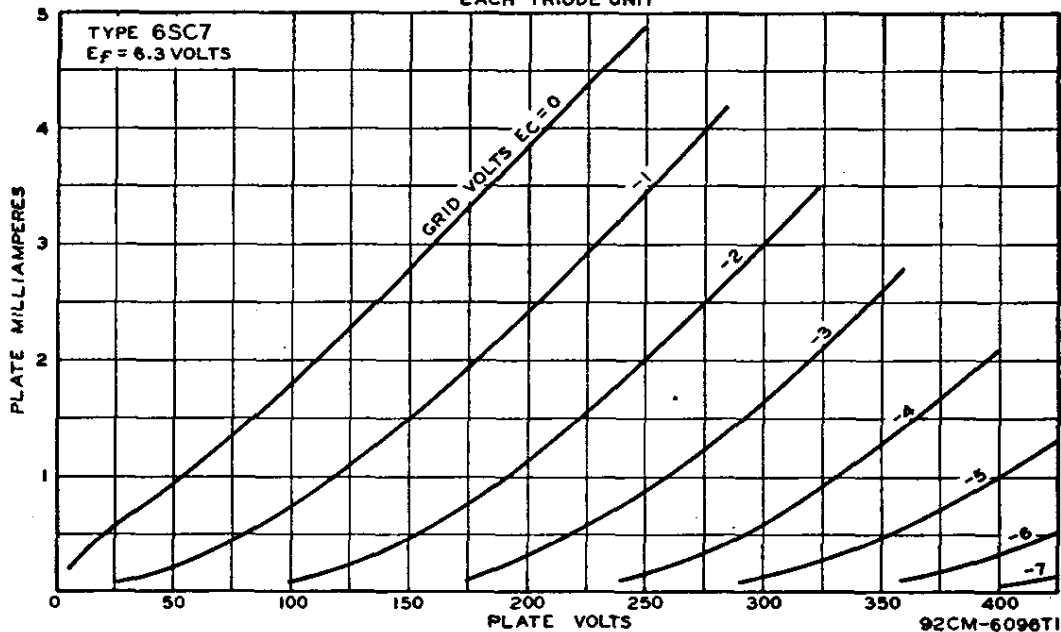

HIGH-MU TRIODE

**6SF5
6SF5-GT**

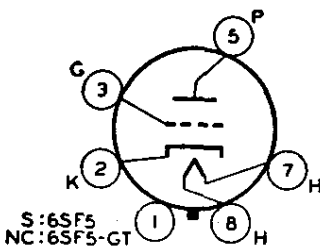

Metal type 6SF5 and glass-octal type 6SF5-GT are used in resistance-coupled amplifier circuits. Outlines 3 and 17, respectively, OUTLINES SECTION. Tubes require octal socket and may be mounted in any position. Characteristics, application, and references under type 6F5 apply to types 6SF5 and 6SF5-GT. Heater volts (ac/dc), 6.3; amperes, 0.3.

**DIODE—
REMOTE-CUTOFF PENTODE**

6SF7

Metal type used as combined rf or if amplifier and detector or avc tube in radio receivers. Also used as resistance-coupled af amplifier. Outline 3, OUTLINES SECTION. Tube requires octal socket and may be mounted in any position. For heater and cathode considerations, refer to type 6AT6. For typical operation as a resistance-coupled amplifier, refer to Chart 19, RESISTANCE-COUPLED AMPLIFIER SECTION.

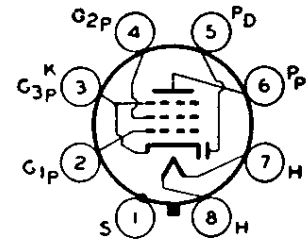

HEATER VOLTAGE (AC/DC)	6.3	volts
HEATER CURRENT	0.3	ampere
DIRECT INTERELECTRODE CAPACITANCES (Shell connected to cathode):		
Pentode Unit:		
Grid No. 1 to Plate	0.004 max	$\mu\mu\text{f}$
Input	5.5	$\mu\mu\text{f}$
Output	6.0	$\mu\mu\text{f}$
Pentode Grid No.1 to Diode	0.002 max	$\mu\mu\text{f}$
Pentode Plate to Diode	0.8	$\mu\mu\text{f}$

Maximum Ratings: CLASS A₁ AMPLIFIER (Pentode Unit)

PLATE VOLTAGE	300 max	volts
GRID-NO.2 (SCREEN) VOLTAGE	100 max	volts
GRID-NO.2 SUPPLY VOLTAGE	300 max	volts
GRID-NO.1 (CONTROL-GRID) VOLTAGE	0 min	volts
PLATE DISSIPATION	3.5 max	watts
GRID-NO.2 DISSIPATION	0.5 max	watt
PEAK HEATER-CATHODE VOLTAGE:		
Heater negative with respect to cathode	90 max	volts
Heater positive with respect to cathode	90 max	volts

Typical Operation:

Plate Voltage	100	250	volts
Grid-No.2 Voltage	100	100	volts
Grid-No.1 Voltage	-1	-1	volt
Plate Resistance (Approx.)	0.2	0.7	megohm
Transconductance	1975	2050	μmhos
Grid-No.1 Bias (Approx.) for transconductance of 10 μmhos ...	-35	-35	volts
Plate Current	12	12.4	ma
Grid-No. 2 Current	3.4	3.3	ma

DIODE UNIT

The diode plate is placed around the cathode, the sleeve of which is common to the pentode unit. For diode operation curves, refer to type 6SQ7.

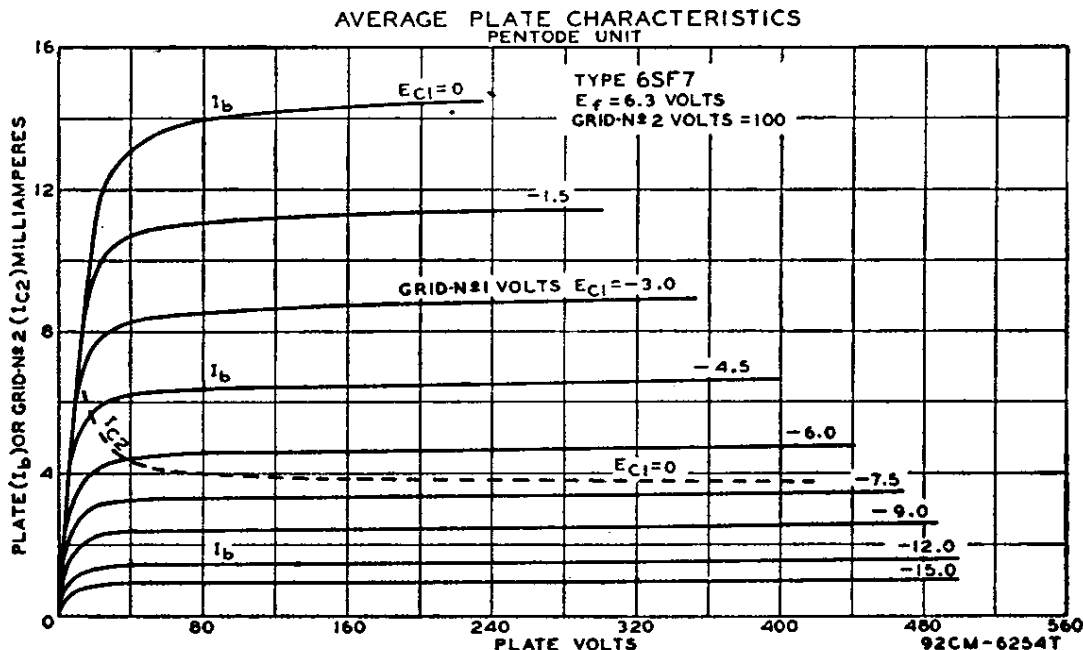

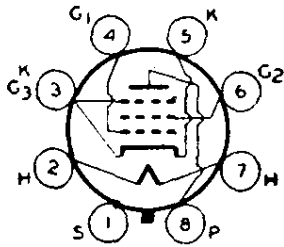

REMOTE-CUTOFF PENTODE

6SG7

Metal type used as rf amplifier in high-frequency and wide-band applications. Features high transconductance with low grid-plate capacitance. Suitable for frequencies up to

18 megacycles (approx.). Two separate cathode terminals enable the input and output circuits to be effectively isolated from each other. Outline 3, OUTLINES SECTION. Tube requires octal socket and may be mounted in any position. For heater and cathode considerations, refer to type 6AT6.

HEATER VOLTAGE (AC/DC).....	6.3	volts
HEATER CURRENT.....	0.3	ampere
DIRECT INTERELECTRODE CAPACITANCES (Shell connected to cathode):		
Grid No.1 to Plate.....	0.003 max	μf
Input.....	8.5	μf
Output.....	7.0	μf

Maximum Ratings:

CLASS A₁ AMPLIFIER

PLATE VOLTAGE.....	300 max	volts
GRID-NO.2 (SCREEN) VOLTAGE.....	200 max	volts
GRID-NO.2 SUPPLY VOLTAGE.....	300 max	volts
GRID-NO.1 (CONTROL-GRID) VOLTAGE.....	0 min	volts
PLATE DISSIPATION.....	3 max	watts
GRID-NO.2 DISSIPATION.....	0.6 max	watt
PEAK HEATER-CATHODE VOLTAGE:		
Heater negative with respect to cathode.....	90 max	volts
Heater positive with respect to cathode.....	90 max	volts

Typical Operation:

Plate Voltage.....	100	250	250	volts
Grid-No.2 Voltage.....	100	125	150	volts
Grid-No.1 Voltage.....	-1	-1	-2.5	volts
Grid No.3 (Suppressor).....	Connected to pin No. 3 internally			
Plate Resistance (Approx.).....	0.25	0.9	+	megohm
Transconductance.....	4100	4700	4000	μmhos
Grid-No.1 Bias (Approx.) for transconductance of 40 μmhos	-11.5	-14	-17.5	volts
Plate Current.....	8.2	11.8	9.2	ma
Grid-No.2 Current.....	3.2	4.4	3.4	ma

+ Greater than 1 megohm.

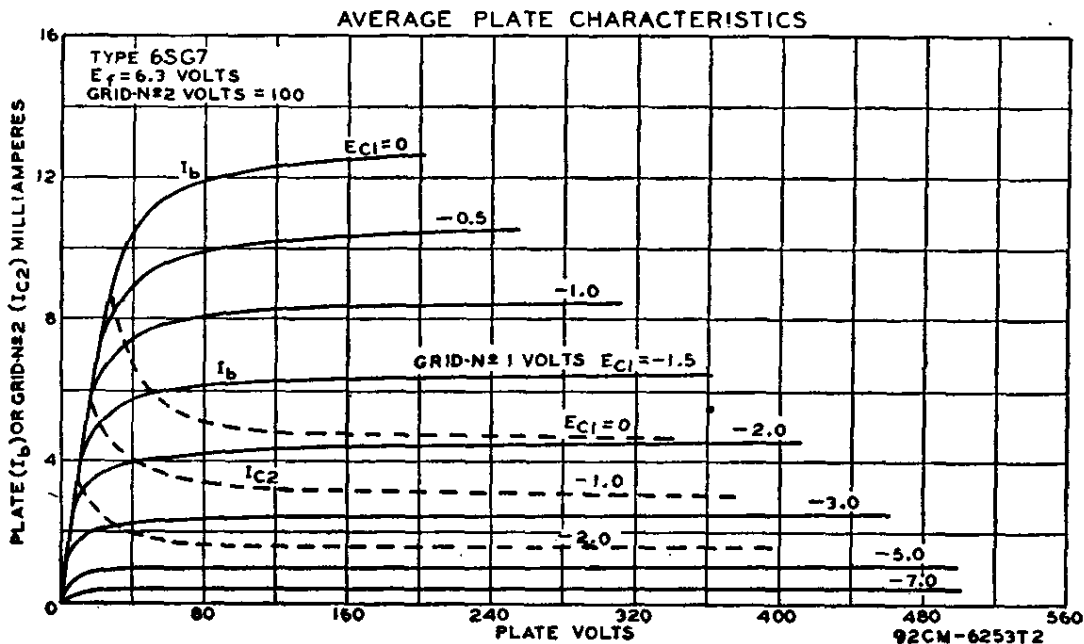

SHARP-CUTOFF PENTODE

6SH7

Metal type used as rf amplifier in high-frequency, wide-band applications and as a limiter tube in FM equipment. Similar electrically to miniature type 6AU6. It features high

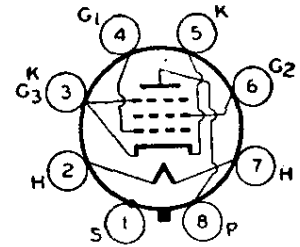

transconductance and low grid-plate capacitance. Outline 3, OUTLINES SECTION. Tube requires octal socket and may be mounted in any position. Two separate cathode terminals enable the input and output circuits to be isolated effectively from each other. This type is not recommended for high-gain, audio-amplifier applications because undesirable hum may be encountered. For heater and cathode considerations, refer to type 6AT6. For typical operation as a resistance-coupled amplifier, refer to Chart 9, RESISTANCE-COUPLED AMPLIFIER SECTION.

HEATER VOLTAGE (AC/DC)	6.3	volts
HEATER CURRENT	0.3	ampere
DIRECT INTERELECTRODE CAPACITANCES (Shell connected to cathode):		
Grid No.1 to Plate	0.003 max	$\mu\mu\text{f}$
Input	8.5	$\mu\mu\text{f}$
Output	7.0	$\mu\mu\text{f}$

Maximum Ratings:

CLASS A₁ AMPLIFIER

PLATE VOLTAGE	300 max	volts
GRID-NO.2 (SCREEN) VOLTAGE	150 max	volts
GRID-NO.2 SUPPLY VOLTAGE	300 max	volts
PLATE DISSIPATION	3 max	watts
GRID-NO.2 DISSIPATION	0.7 max	watt
GRID-NO.1 (CONTROL-GRID) VOLTAGE	0 min	volts
PEAK HEATER-CATHODE VOLTAGE:		
Heater negative with respect to cathode	90 max	volts
Heater positive with respect to cathode	90 max	volts

Typical Operation:

Plate Voltage	100	250	volts
Grid-No.2 Voltage	100	150	volts
Grid-No.1 Voltage	-1	-1	volt
Plate Resistance (Approx.)	0.35	0.9	megohm
Transconductance	4000	4900	μmhos
Grid-No.1 Bias for plate current of 10 μa	-4.0	-5.5	volts
Plate Current	5.3	10.8	ma
Grid-No.2 Current	2.1	4.1	ma

AVERAGE PLATE CHARACTERISTICS

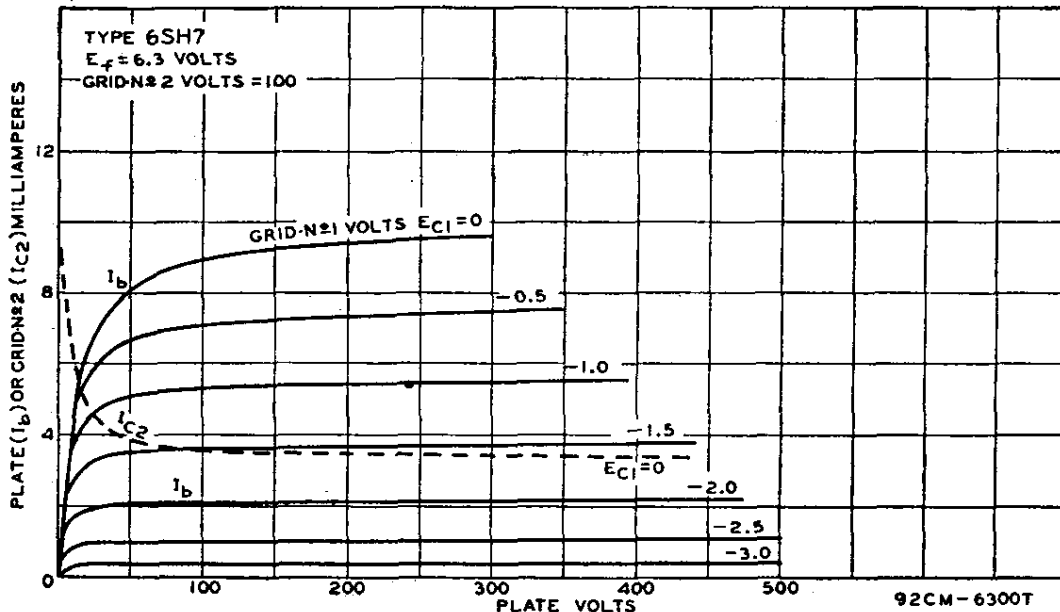

SHARP-CUTOFF PENTODE

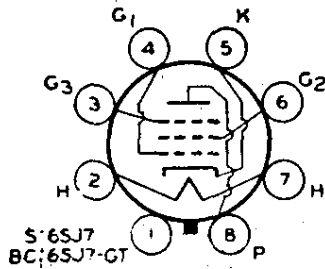

Metal type 6SJ7 and glass-octal type 6SJ7-GT are used as rf amplifiers and biased detectors. As a detector, either type is capable of delivering large audio-frequency output voltage with relatively small input voltage.

6SJ7
6SJ7-GT

HEATER VOLTAGE (AC/DC).....	6.3	volts
HEATER CURRENT.....	0.3	ampere
DIRECT INTERELECTRODE CAPACITANCES: ^o		
Pentode Connection:		
Grid No.1 to Plate.....	0.005 max	0.005 max μμf
Input.....	6.0	6.3 μμf
Output.....	7.0	10 μμf
Triode Connection:+		
Grid to Plate.....	2.8	2.8 μμf
Grid to Cathode.....	3.4	3.4 μμf
Plate to Cathode.....	11	11 μμf

^o With shell or external shield connected to cathode.
+ With grids No.2 and No.3 connected to plate.

CLASS A₁ AMPLIFIER

Maximum Ratings:

	Triode Connection	Pentode Connection	
PLATE VOLTAGE.....	250 max	300 max	volts
GRID-NO.2 (SCREEN) VOLTAGE.....	-	125 max	volts
GRID-NO.2 SUPPLY VOLTAGE.....	-	300 max	volts
GRID-NO.1 (CONTROL-GRID) VOLTAGE.....	0 min	0 min	volts
PLATE DISSIPATION.....	2.5 max	2.5 max	watts
GRID-NO.2 DISSIPATION.....	-	0.70 max	watt
PEAK HEATER-CATHODE VOLTAGE:			
Heater negative with respect to cathode.....	90 max	90 max	volts
Heater positive with respect to cathode.....	90 max	90 max	volts

Typical Operation:

	Triode Connection		Pentode Connection		
Plate Voltage.....	180	250	100	250	volts
Grid-No.2 Voltage.....	*	*	100	100	volts
Grid-No.1 Voltage.....	-6	-8.5	-3	-3	volts
Grid No.3 (Suppressor).....	*	*	Connected to cathode at socket		
Amplification Factor.....	19	19	-	-	
Plate Resistance.....	8250	7600	700000	†	ohms
Transconductance.....	2300	2500	1575	1650	μmhos
Grid-No.1 Bias for plate current of 10 μa.....	-	-	-8	-8	volts
Plate Current.....	6.0	9.2	2.9	3.0	ma
Grid-No.2 Current.....	-	-	0.9	0.8	ma

* Grids No.2 and No.3 connected to plate. † Greater than 1 megohm.

INSTALLATION AND APPLICATION

Types 6SJ7 and 6SJ7-GT require octal socket and may be mounted in any position. Outlines 3 and 19, respectively, OUTLINES SECTION. For heater and cathode considerations, refer to type 6AT6.

As a class A₁ amplifier, the 6SJ7 or 6SJ7-GT may be operated either as a pentode or as a triode, as shown under tabulated data. The grid-No.2 voltage for the 6SJ7 operated as a pentode may be obtained from a potentiometer or bleeder circuit across the B-supply device. Due to the grid-No.2-current characteristics of the 6SJ7, a resistor in series with the high-voltage supply may be employed for obtaining the grid-No.2 voltage, provided the cathode-resistor method of bias control is used. This method, however, is not recommended if the high-voltage B-supply exceeds 300 volts.

As a radio-frequency amplifier, the 6SJ7 or 6SJ7-GT may be used particularly in applications where the rf signal applied to grid No.1 is relatively low, that is, of the order of a few volts. In such cases either grid-No.2 or grid-No.1 voltage (or both) may be varied to control the receiver volume. When larger signals are involved, a remote-cutoff amplifier tube should be employed to prevent the occurrence of excessive cross-modulation and modulation-distortion.

As an audio-frequency amplifier in resistance-coupled circuits, the 6SJ7 or 6SJ7-GT may be operated under conditions shown in Chart 20, RESISTANCE-COUPLED AMPLIFIER SECTION.

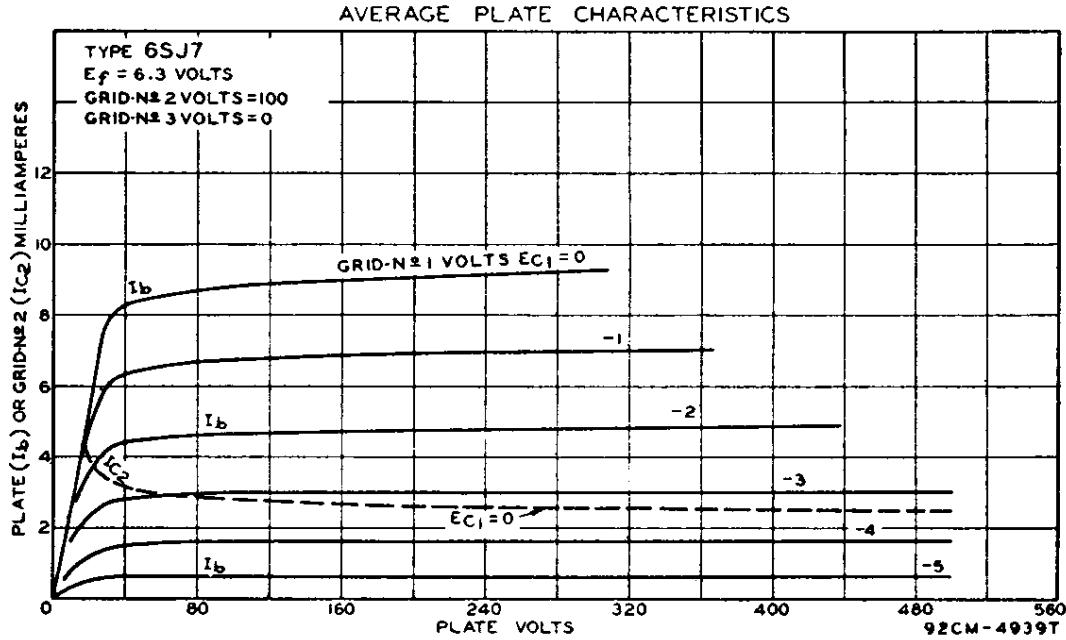

6SK7 6SK7-GT

REMOTE-CUTOFF PENTODE

Metal type 6SK7 and glass-octal type 6SK7-GT are used as rf or if amplifiers in radio receivers. They feature single-ended construction and interlead shields. Because of remote-cutoff

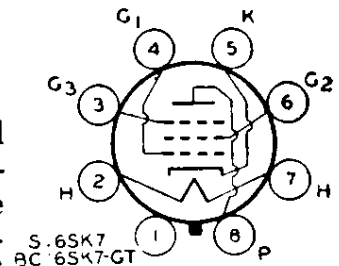

characteristic, these types are able to handle large signal voltages without cross-modulation or modulation-distortion and are often used in receivers with avc.

HEATER VOLTAGE (AC/DC).....	6.3	volts
HEATER CURRENT.....	0.3	ampere
DIRECT INTERELECTRODE CAPACITANCES:		
	<i>6SK7*</i>	<i>6SK7-GT**</i>
Grid No.1 to Plate.....	0.003 max	0.005 max
Input.....	6.0	6.5
Output.....	7.0	7.5
		μf

* With shell connected to cathode. ** With external shield connected to cathode.

Maximum Ratings:

CLASS A₁ AMPLIFIER

PLATE VOLTAGE.....	300 max	volts
GRID-NO.2 (SCREEN) VOLTAGE.....	125 max	volts
GRID-NO.2 SUPPLY VOLTAGE.....	300 max	volts
GRID-NO.1 (CONTROL-GRID) VOLTAGE.....	0 min	volts
PLATE DISSIPATION.....	4.0 max	watts
GRID-NO.2 DISSIPATION.....	0.4 max	watt
PEAK HEATER-CATHODE VOLTAGE:		
Heater negative with respect to cathode.....	90 max	volts
Heater positive with respect to cathode.....	90 max	volts

Typical Operation:

Plate Voltage.....	100	250	volts
Grid-No.2 Voltage.....	100	100	volts
Grid-No.1 Voltage.....	-1	-3	volts
Grid No.3 (Suppressor).....	Connected to cathode at socket		
Plate Resistance (Approx.).....	0.12	0.8	megohm
Transconductance.....	2350	2000	μ mhos
Grid-No.1 Bias for transconductance of 10 μ mhos.....	-35	-35	volts
Plate Current.....	13	9.2	ma
Grid-No.2 Current.....	4.0	2.6	ma

INSTALLATION AND APPLICATION

Types 6SK7 and 6SK7-GT require octal socket and may be mounted in any position. Outlines 3 and 19, respectively, OUTLINES SECTION. For heater and cathode considerations, refer to type 6AT6.

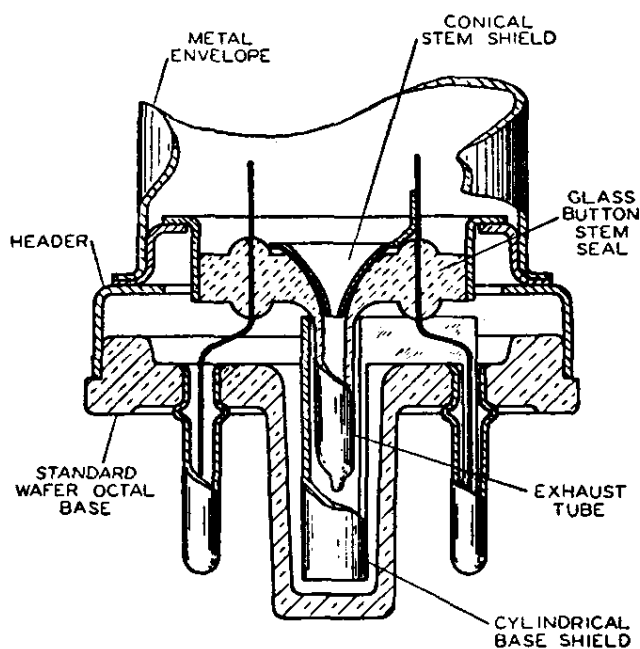

The interlead shielding within the base of the 6SK7 and other types employing this construction is accomplished by means of a conical stem shield and a cylindrical base shield. The metal cone is inserted through the hole in the stem where the exhaust tube connects. The cone extends some distance into the exhaust tube and is connected to the common grounding pin (pin No.1). The cylindrical base shield is positioned inside the locating base plug, and is also connected to pin No.1. The conical shield reduces the capacitance between leads in the glass of the stem: the cylindrical shield reduces the capacitance between those pins that are diametrically opposite each other. Since the grid-No.1 and the plate leads are diametrically opposite,

the capacitance between them is kept to a value comparable with that obtainable with top-cap construction.

Control-grid bias variation will be found effective in changing the volume of the receiver. In order to obtain adequate volume control, an available grid-bias voltage of approximately 50 volts will be required. The exact value will depend upon the circuit design and operating conditions. This voltage may be obtained, depending on the receiver requirements, from a potentiometer across a fixed supply voltage, from a variable cathode-bias resistor, from the avc system, or from a combination of these methods.

The grid-No.2 (screen) voltage may be obtained from a potentiometer or bleeder circuit across the B-supply source, or through a dropping resistor from the plate supply. The use of series resistors for obtaining satisfactory control of grid-No.2 voltage in the case of four-electrode tubes is usually impossible because of secondary-emission phenomena. In the 6SK7, however, because grid No.3 practically removes these effects, it is possible to obtain grid-No.2 voltage through a series-dropping resistor from the plate supply or from some high intermediate voltage providing these sources do not exceed the plate-supply voltage. With this method, the grid-No.2-to-cathode voltage will fall off very little from minimum to maximum value of the resistor controlling cathode bias. In some cases, it may actually rise. This rise of grid-No.2-to-cathode voltage above the normal maximum value is allowable because both the grid-No.2 current and the plate current are reduced simultaneously by a sufficient amount to prevent damage to the tube. It

should be recognized that, in general, the series-resistor method of obtaining grid-No.2 voltage from a higher voltage supply necessitates the use of the variable cathode-resistor method of controlling volume in order to prevent too high a voltage on grid No.2. When grid-No.2 and control-grid voltage are obtained in this manner, the remote "cutoff" advantage of the 6SK7 and 6SK7-GT can be fully realized. However, it should be noted that the use of a resistor in the grid-No.2 circuit will have an effect on the change in plate resistance with variation in grid-No.3 (suppressor) voltage in case grid No.3 is utilized for control purposes.

Grid No.3 (suppressor) may be connected directly to the cathode or it may be made negative with respect to the cathode. For the latter condition, the grid-No.3 voltage may be obtained from a potentiometer or bleeder circuit, or from the avc system.

For circuits employing the 6SK7, refer to the CIRCUIT SECTION.

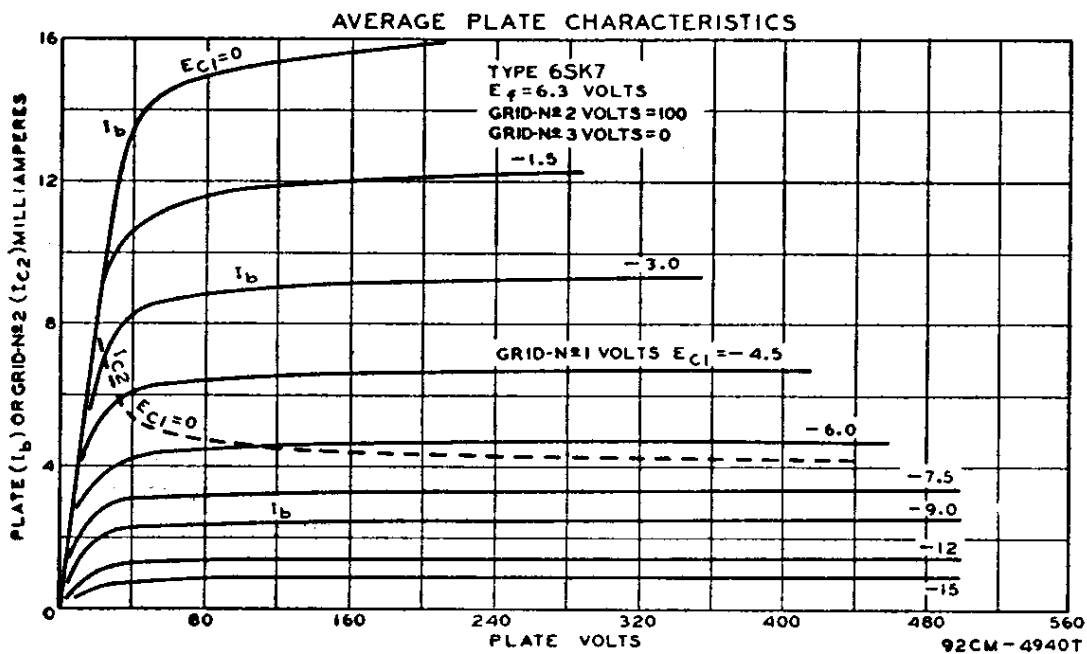

6SL7-GT

HIGH-MU TWIN TRIODE

Glass octal type used as phase inverter or resistance-coupled amplifier in radio equipment. Outline 17, OUTLINES SECTION. Tube requires octal socket and may be mounted in

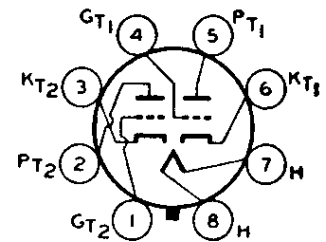

any position. Except for the common heater, each triode unit is independent of the other. For typical operation as phase inverter or resistance-coupled amplifier, refer to Chart 7, RESISTANCE-COUPLED AMPLIFIER SECTION. For heater and cathode considerations, refer to type 6AT6.

HEATER VOLTAGE (AC/DC)..... 6.3 volts
 HEATER CURRENT..... 0.3 ampere

DIRECT INTERELECTRODE CAPACITANCES (Approx.):°

	Triode Unit T ₁	Triode Unit T ₂	
Grid to Plate.....	2.8	2.8	μf
Grid to Cathode.....	3.0	3.4	μf
Plate to Cathode.....	3.8	3.2	μf

° With close-fitting shield connected to cathode.

Maximum Ratings:
CLASS A₁ AMPLIFIER (Each Unit)

PLATE VOLTAGE.....	250 max	volts
GRID VOLTAGE.....	0 min	volts
PLATE DISSIPATION.....	1 max	watt
PEAK HEATER-CATHODE VOLTAGE:		
Heater negative with respect to cathode.....	90 max	volts
Heater positive with respect to cathode.....	90 max	volts

Typical Operation:

Plate Voltage.....	250	volts
Grid Voltage.....	-2	volts
Amplification Factor.....	70	
Plate Resistance.....	44000	ohms
Transconductance.....	1600	μmhos
Plate Current.....	2.3	ma

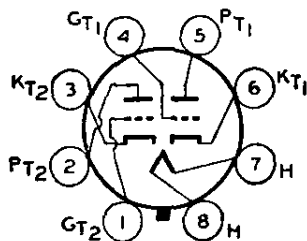
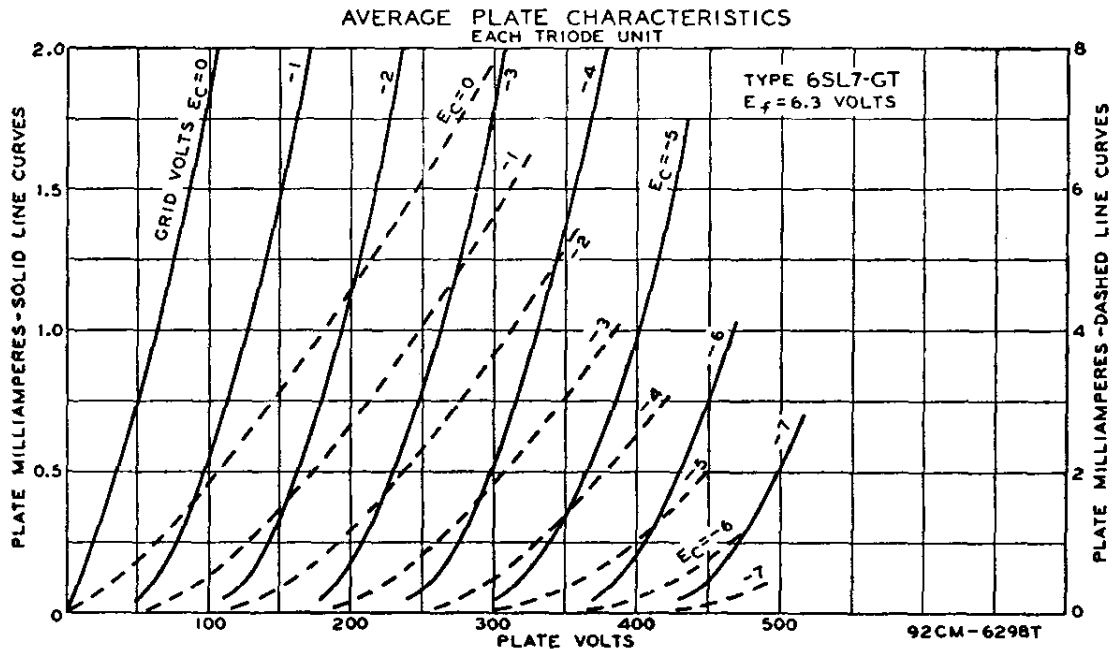

MEDIUM-MU TWIN TRIODE

6SN7-GT

Glass octal type used as phase inverter or resistance-coupled amplifier in radio equipment. Outline 17, OUTLINES SECTION. Tube requires octal socket and may be mounted in

any position. Each triode unit is independent of the other except for the common heater. For maximum ratings, typical operation, and curves for each triode unit, refer to type 6J5. For typical operation as phase inverter or resistance-coupled amplifier, refer to Chart 13, RESISTANCE-COUPLED AMPLIFIER SECTION. For heater and cathode considerations, refer to type 6AQ5.

HEATER VOLTAGE (AC/DC).....	6.3	volts
HEATER CURRENT.....	0.6	ampere

DIRECT INTERELECTRODE CAPACITANCES (Approx. With no external shield):

	Triode Unit T ₁	Triode Unit T ₂	
Grid to Plate.....	3.8	4.0	μμf
Grid to Cathode.....	2.8	3.0	μμf
Plate to Cathode.....	0.8	1.2	μμf

6SQ7
6SQ7-GT

TWIN DIODE—HIGH-MU TRIODE

Metal type 6SQ7 and glass-octal type 6SQ7-GT used as combined detector, amplifier, and avc tube in radio receivers. These types are similar electrically to type 6Q7 in many respects, but they have a higher-mu triode.

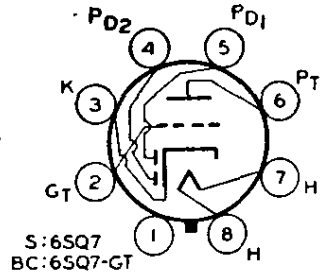

HEATER VOLTAGE (AC/DC).....	6.3	volts
HEATER CURRENT.....	0.3	ampere

DIRECT INTERELECTRODE CAPACITANCES—Triode Unit:*		6SQ7 ^o	6SQ7-GT ^{oo}	
Grid to Plate.....	1.6	1.8	$\mu\mu\text{f}$	
Grid to Cathode.....	3.2	4.2	$\mu\mu\text{f}$	
Plate to Cathode.....	3.0	3.4	$\mu\mu\text{f}$	

^o With shell connected to cathode. ^{oo} With no external shield. * Approximate.

Maximum Ratings: CLASS A₁ AMPLIFIER (Triode Unit)

PLATE VOLTAGE.....	300 <i>max</i>	volts
PEAK HEATER-CATHODE VOLTAGE:		
Heater negative with respect to cathode.....	90 <i>max</i>	volts
Heater positive with respect to cathode.....	90 <i>max</i>	volts

Characteristics:

Plate Voltage.....	100	250	volts
Grid Voltage.....	-1	-2	volts
Amplification Factor.....	100	100	
Plate Resistance.....	110000	91000	ohms
Transconductance.....	900	1100	μmhos
Plate Current.....	0.4	0.9	ma

DIODE UNITS

Two diode plates are placed around a cathode, the sleeve of which is common to the triode unit. Each diode plate has its own base pin. Diode operation curves are given below.

AVERAGE CHARACTERISTICS
HALF-WAVE RECTIFICATION-SINGLE DIODE UNIT

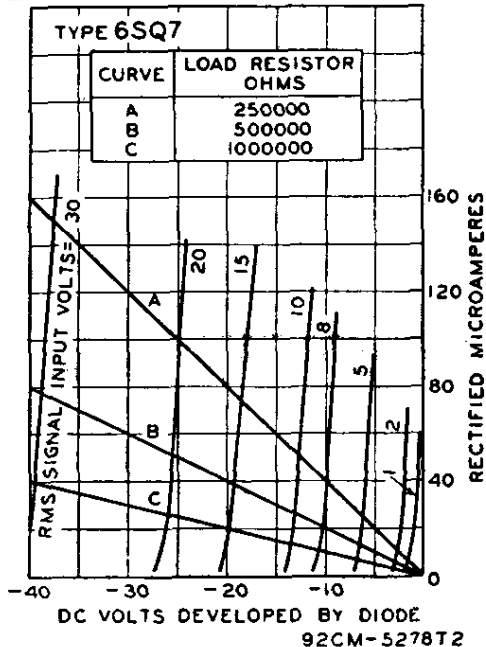

INSTALLATION AND APPLICATION

Types 6SQ7 and 6SQ7-GT require octal socket and may be mounted in any position. Outlines 3 and 19, respectively, OUTLINES SECTION. For heater and cathode considerations, refer to type 6AT6.

The triode unit of the 6SQ7 and 6SQ7-GT is recommended for use only in resistance-coupled circuits; refer to Chart 4, RESISTANCE-COUPLED AMPLIFIER SECTION. Diode-biasing of the triode unit is not suitable because of the probability of triode plate-current cutoff even with relatively small signal voltages applied to the diode circuit.

AVERAGE PLATE CHARACTERISTICS
TRIODE UNIT

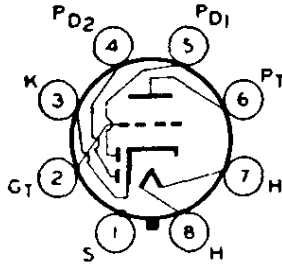
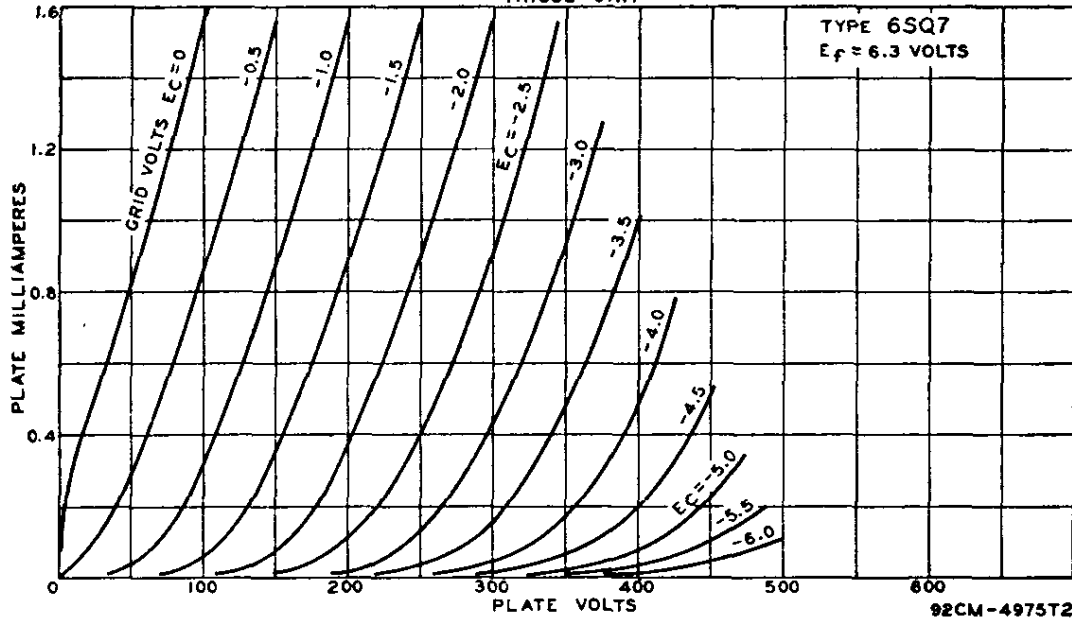

TWIN DIODE— MEDIUM-MU TRIODE

6SR7

Metal type used as combined detector, amplifier, and avc tube. It is equivalent in performance to miniature type 6BF6. Outline 3, OUTLINES SECTION. Tube requires octal socket

and may be mounted in any position. For typical operation as a resistance-coupled amplifier, refer to Chart 9, RESISTANCE-COUPLED AMPLIFIER SECTION. For heater and cathode considerations, refer to type 6AT6.

HEATER VOLTAGE (AC/DC).....	6.3	volts
HEATER CURRENT.....	0.3	ampere
DIRECT INTERELECTRODE CAPACITANCES—Triode Unit:*		
Grid to Plate.....	2.4	μf
Grid to Cathode.....	3.0	μf
Plate to Cathode.....	2.8	μf

* Shell connected to cathode. Values are approximate.

Maximum Ratings:	CLASS A₁ AMPLIFIER (Triode Unit)	
PLATE VOLTAGE.....	250 max	volts
PLATE DISSIPATION.....	2.5 max	watts
PEAK HEATER-CATHODE VOLTAGE:		
Heater negative with respect to cathode.....	90 max	volts
Heater positive with respect to cathode.....	90 max	volts

Typical Operation with Transformer Coupling:		
Plate Voltage.....	250	volts
Grid Voltage.....	-9	volts
Amplification Factor.....	16	
Plate Resistance.....	8500	ohms
Transconductance.....	1900	μmhos
Plate Current.....	9.5	ma
Load Resistance.....	10000	ohms
Power Output.....	300	mw

DIODE UNITS

Two diode plates are placed around a cathode, the sleeve of which is common to the triode unit. Each diode plate has its own base pin. For diode operation curves, refer to type 6SQ7.

REMOTE-CUTOFF PENTODE

6SS7

Metal type used in rf or if stages of radio receivers particularly those employing avc. Outline 3, OUTLINES SECTION. Tube requires octal socket and may be mounted in any position. For heater and cathode considerations, refer to type 6AT6.

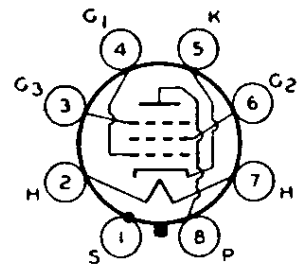

HEATER VOLTAGE (AC/DC).....	6.3	volts
HEATER CURRENT.....	0.15	ampere
DIRECT INTERELECTRODE CAPACITANCES (Approx.):*		
Grid No.1 to Plate.....	0.004 max	$\mu\mu\text{f}$
Input.....	5.5	$\mu\mu\text{f}$
Output.....	7.0	$\mu\mu\text{f}$

* With shell connected to cathode.

Maximum Ratings:

CLASS A₁ AMPLIFIER

PLATE VOLTAGE.....	300 max	volts
GRID-NO.2 (SCREEN) VOLTAGE.....	100 max	volts
GRID-NO.2 SUPPLY VOLTAGE.....	300 max	volts
GRID-NO.1 (CONTROL-GRID) VOLTAGE.....	0 min	volts
PLATE DISSIPATION.....	2.25 max	watts
GRID-NO.2 DISSIPATION.....	0.35 max	watt
PEAK HEATER-CATHODE VOLTAGE:		
Heater negative with respect to cathode.....	90 max	volts
Heater positive with respect to cathode.....	90 max	volts

Typical Operation:

Plate Voltage.....	100	250	volts
Grid-No.2 Voltage.....	100	100	volts
Grid-No.1 Voltage.....	-1	-3	volts
Grid No.3 (Suppressor).....	Connected to cathode at socket		
Plate Resistance (Approx.).....	0.12	1	megohm
Transconductance.....	1930	1850	μmhos
Grid-No.1 Bias for transconductance of 10 μmhos	-35	-35	volts
Plate Current.....	12.2	9	ma
Grid-No.2 Current.....	3.1	2	ma

TWIN DIODE—MEDIUM-MU TRIODE

6ST7

Metal type used as combined detector, amplifier, and avc tube. Within maximum ratings this type is electrically identical to type 6BF6 except for interelectrode capacitances and heater current. Outline 3, OUTLINES SECTION. Tube requires octal socket and may be mounted in any position. Heater volts (ac/dc), 6.3; amperes, 0.15. Maximum ratings of triode

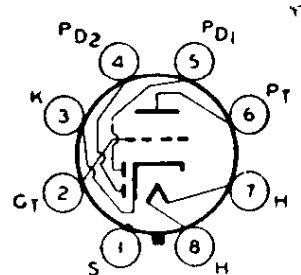

unit as class A₁ amplifier: plate volts, 250 max; plate dissipation, 2.5 max watts. For diode operation curves, refer to type 6SQ7.

TWIN DIODE—HIGH-MU TRIODE

6SZ7

Metal type used as combined detector, amplifier, and avc tube in radio receivers. Except for heater-current rating and interelectrode capacitances, this type is essentially the same elec-

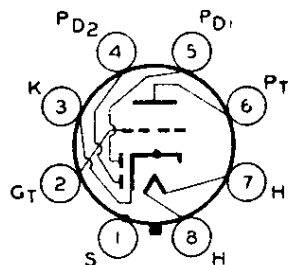

trically as type 6AT6. Outline 3, OUTLINES SECTION. Tube requires octal socket and may be mounted in any position. Heater volts (ac/dc), 6.3; amperes, 0.15. Direct interelectrode capacitances of triode unit (shell connected to cathode): grid to plate, 1.1 $\mu\mu\text{f}$; grid to cathode, 2.4 $\mu\mu\text{f}$; plate to cathode, 2.8 $\mu\mu\text{f}$. For diode operation curves, refer to type 6SQ7.

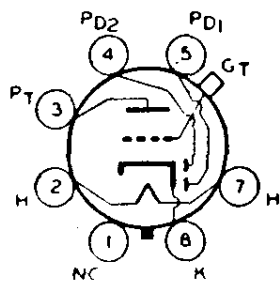

TWIN DIODE—HIGH-MU TRIODE

6T7-G

Glass octal type used as combined detector, amplifier, and avc tube in radio receivers. Outline 26, OUTLINES SECTION. For heater and cathode considerations, refer to type 6AT6. Heater volts (ac/dc), 6.3; amperes, 0.15. Refer to Chart 7, RESISTANCE-COUPLED AMPLIFIER SECTION for typical operation as a resistance-coupled amplifier. Typical operation as class A₁ amplifier: plate volts, 250 max; grid volts, -3; plate ma., 1.2; plate resistance, 62000 ohms; amplification factor, 65; transconductance, 1050 μmhos. For diode operation curves, refer to type 6SQ7. Type 6T7-G is used principally for renewal purposes.

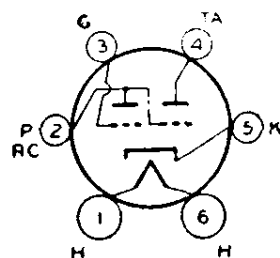

ELECTRON-RAY TUBE

6U5/6G5

Glass type used to indicate visually by means of a fluorescent target the effects of a change in a controlling voltage. It is used as a convenient, non-mechanical means of indicating accurate radio-receiver tuning. Outline 23, OUTLINES SECTION. Tube requires six-contact socket and may be mounted in any position. For heater and cathode considerations, refer to type 6AT6. Type 6U5/6G5 has a remote plate-current cutoff characteristic. For a discussion of electron-ray tube considerations, refer to ELECTRON TUBE APPLICATION SECTION.

HEATER VOLTAGE (AC/DC)	6.3	volts
HEATER CURRENT	0.3	ampere

Maximum Ratings:

INDICATOR SERVICE

PLATE-SUPPLY VOLTAGE	285 max	volts
TARGET VOLTAGE	{ 285 max	volts
	{ 125 min	volts
PLATE DISSIPATION	1 max	watt
PEAK HEATER-CATHODE VOLTAGE:		
Heater negative with respect to cathode	90 max	volts
Heater positive with respect to cathode	90 max	volts

Typical Operation:

Plate- and Target-Supply Voltage	200	250	volts
Series Triode-Plate Resistor	1	1	megohm
Target Current (For zero grid voltage)	3.0	4.0	ma
Triode Plate Current (For zero grid voltage)	0.19	0.24	ma
Triode Grid Voltage (Approx. for 0° shadow angle)	-18.5	-22	volts
Triode Grid Voltage (Approx. for 90° shadow angle)	0	0	volts

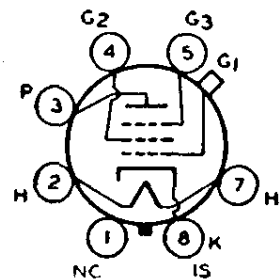

REMOTE-CUTOFF PENTODE

6U7-G

Glass octal type used in rf and if stages of radio receivers employing avc. It is also used as a mixer in superheterodyne circuits. Outline 30, OUTLINES SECTION. Tube requires octal socket. Refer to type 6SK7 for general application information. Heater volts (ac/dc), 6.3; amperes, 0.3. This type is used principally for renewal purposes. Maximum ratings as class A₁ amplifier: plate volts, 300; grid-No.2 (screen) volts, 100; grid-No.2 supply volts, 300; grid-No.1 (control-grid) volts, 0 min; plate dissipation, 2.25 watts; grid-No.2 dissipation, 0.25 watt.

Typical Operation:

Plate Voltage	100	250	volts
Grid-No.2 Voltage	100	100	volts
Grid-No.1 Voltage	-3	-3	volts
Grid No.3 (Suppressor)	Connected to cathode at socket		
Plate Resistance (Approx.)	0.25	0.8	megohm
Transconductance	1500	1600	μmhos
Grid-No.1 Bias for transconductance of 2 μmhos	-50	-50	volts
Plate Current	8	8.2	ma
Grid-No.2 Current	2.2	2	ma

6V6 6V6-GT

BEAM POWER AMPLIFIER

Metal type 6V6 and glass-octal type 6V6-GT are used as output amplifiers in automobile, battery-operated, and other receivers in which reduced plate-current drain is desirable. Out-

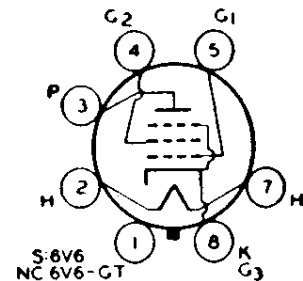

lines 6 and 17, respectively, OUTLINES SECTION. Tubes require octal socket and may be mounted in any position. The 6V6 and 6V6-GT are equivalent in performance to type 6AQ5. Refer to type 6AQ5 for heater and cathode considerations, application information, and characteristic curves.

HEATER VOLTAGE (AC/DC).....	6.3	volts	
HEATER CURRENT.....	0.45	ampere	
DIRECT INTERELECTRODE CAPACITANCES (Approx.):	6V6 ^o	6V6-GT ^{oo}	
Grid No.1 to Plate.....	0.3	0.7	μf
Input.....	10	9.5	μf
Output.....	11	7.5	μf

^o With shell connected to cathode. ^{oo} With no external shield.

Maximum Ratings: SINGLE-TUBE CLASS A₁ AMPLIFIER

PLATE VOLTAGE.....	315 max	volts
GRID-NO.2 (SCREEN) VOLTAGE.....	285 max	volts
PLATE DISSIPATION.....	12 max	watts
GRID-NO.2 DISSIPATION.....	2 max	watts
PEAK HEATER-CATHODE VOLTAGE:		
Heater negative with respect to cathode.....	90 max	volts
Heater positive with respect to cathode.....	90 max	volts

Typical Operation:

Plate Voltage.....	180	250	315	volts
Grid-No.2 Voltage.....	180	250	225	volts
Grid-No.1 (Control-Grid) Voltage.....	-8.5	-12.5	-13	volts
Peak AF Grid-No.1 Voltage.....	8.5	12.5	13	volts
Zero-Signal Plate Current.....	29	45	34	ma
Maximum-Signal Plate Current.....	30	47	35	ma
Zero-Signal Grid-No.2 Current (Approx.).....	3	4.5	2.2	ma
Maximum-Signal Grid-No.2 Current (Approx.).....	4	7	6	ma
Plate Resistance.....	58000	52000	77000	ohms
Transconductance.....	3700	4100	3750	μmhos
Load Resistance.....	5500	5000	8500	ohms
Total Harmonic Distortion.....	8	8	12	per cent
Maximum-Signal Power Output.....	2	4.5	5.5	watts

Maximum Ratings: PUSH-PULL CLASS AB₁ AMPLIFIER

(Same as for single-tube class A₁ amplifier)

Typical Operation (Values are for two tubes):

Plate Voltage.....	250	285	volts
Grid-No.2 Voltage.....	250	285	volts
Grid-No.1 (Control-Grid) Voltage*.....	-15	-19	volts
Peak AF Grid-No.1-to-Grid-No.1 Voltage.....	30	38	volts
Zero-Signal Plate Current.....	70	70	ma
Maximum-Signal Plate Current.....	79	92	ma
Zero-Signal Grid-No.2 Current (Approx.).....	5	4	ma
Maximum-Signal Grid-No.2 Current (Approx.).....	13	13.5	ma
Plate Resistance (Approx.).....	60000	65000	ohms
Transconductance.....	3750	3600	μmhos
Effective Load Resistance.....	10000	8000	ohms
Total Harmonic Distortion.....	5	3.5	per cent
Maximum-Signal Power Output.....	10	14	watts

* The type of input coupling used should not introduce too much resistance in the grid circuit. Transformer- or impedance-coupling devices are recommended. When the grid-No.1 circuit has a resistance not higher than 0.1 megohm, fixed bias may be used; for higher values, cathode bias is required. With cathode bias, the grid-No.1 circuit may have a resistance not to exceed 0.5 megohm.

TWIN DIODE—MEDIUM-MU TRIODE

Glass octal type used as combined detector, amplifier, and avc tube. Outline 26, OUTLINES SECTION. Except for interelectrode capacitances, this type is identical electrically with type 85. Heater volts (ac/dc), 6.3; amperes, 0.3. For diode operation curves, refer to type 6SQ7. This is a DISCONTINUED type listed for reference only.

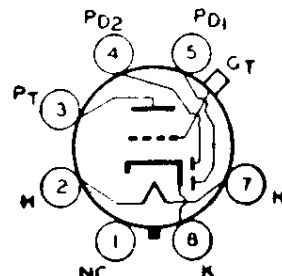

6V7-G

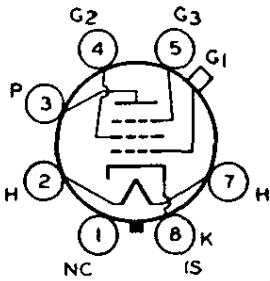

SHARP-CUTOFF PENTODE

Glass octal type used as biased detector or high-gain amplifier in radio receivers. Outline 26, OUTLINES SECTION. Tube requires octal socket. Heater volts (ac/dc), 6.3; amperes, 0.15. Maximum ratings: plate volts, 300 max; grid-No.2 (screen) volts, 100 max; grid-No.2 supply volts, 300 max; grid-No.1 (control-grid) volts, 0 min; plate dissipation, 0.5 max watt; grid-No.2 dissipation, 0.1 max watt. Within its maximum ratings, this type is identical electrically with type 6J7. Type 6W7-G is used principally for renewal purposes.

6W7-G

Maximum ratings, typical operation, and installation information for the 6W7-G tube.

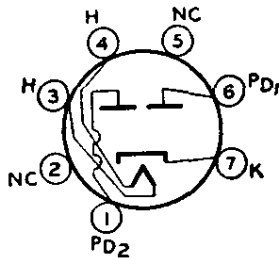

FULL-WAVE VACUUM RECTIFIER

Miniature type used in power supply of automobile and ac-operated radio receivers. Equivalent in performance to larger types 6X5 and 6X5-GT.

6X4

HEATER VOLTAGE (AC/DC) . . . 6.3 volts
HEATER CURRENT 0.6 ampere

FULL-WAVE RECTIFIER

Maximum Ratings:

PEAK INVERSE PLATE VOLTAGE	1250 max	volts
PEAK PLATE CURRENT	210 max	ma
DC OUTPUT CURRENT	70 max	ma
PEAK HEATER-CATHODE VOLTAGE:		
Heater negative with respect to cathode	450 max	volts
Heater positive with respect to cathode	450 max	volts

Typical Operation:

	Capacitor	Choke	
AC Plate-to-Plate Supply Voltage (RMS)	650	900	volts
Filter-Input Capacitor	4	-	μf
Total Effective Plate-Supply Impedance per Plate	150	-	ohms
Min. Filter-Input Choke	-	8	henries
DC Output Current	70	70	ma
DC Output Voltage at Input to Filter (Approx.):			
At half-load current (35 ma.)	390	385	volts
At full-load current (70 ma.)	355	375	volts
Voltage Regulation (Approx.):			
Half-load to full-load current	35	10	volts

INSTALLATION AND APPLICATION

Tube requires miniature seven-contact socket and may be mounted in any position. Outline 13, OUTLINES SECTION. It is especially important that this tube, like other power-handling tubes, should be adequately ventilated.

When operation requires a filter-input capacitor larger than 4 μf, it may be necessary to use more plate-supply impedance than the value shown to limit the peak plate current to the rated value. For additional information on filter circuits, refer to ELECTRON TUBE APPLICATIONS SECTION.

OPERATION CHARACTERISTICS

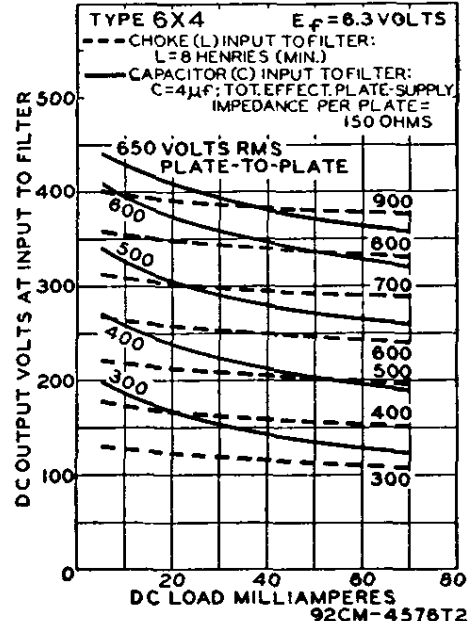

**6X5
6X5-GT**

**FULL-WAVE
VACUUM RECTIFIER**

Metal type 6X5 and glass-octal type 6X5-GT are used in power supply of automobile and ac-operated receivers. Outlines 6 and 17, respectively, OUTLINES SECTION. Both types

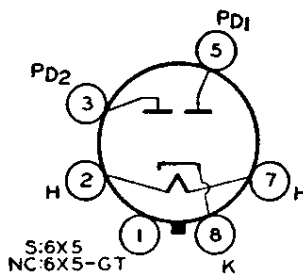

require octal socket. Type 6X5 should be mounted in vertical position, but horizontal operation is permissible if pins 3 and 5 are in horizontal plane. Type 6X5-GT may be operated in any position. For maximum ratings, typical operation data, and curves, refer to type 6X4.

6Y5

FULL-WAVE VACUUM RECTIFIER

Glass type used in power supply of radio receivers. Outline 25, OUTLINES SECTION. Heater volts (ac/dc), 6.3; amperes, 0.8. The maximum ac plate voltage per plate is 350 volts (RMS), and the dc output current is 50 ma. This is a DISCONTINUED type listed for reference only.

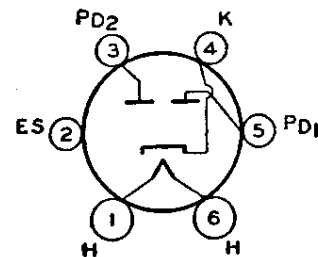

6Y6-G

BEAM POWER AMPLIFIER

Glass octal type used as output amplifier in radio receivers in which the plate voltage available for the output stage is relatively low. It is also used in rf-operated, high-voltage power

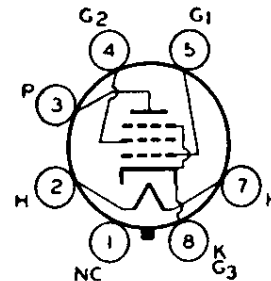

supplies in television equipment. Outline 28, OUTLINES SECTION. Tube requires octal socket and may be mounted in any position. Heater volts (ac/dc), 6.3; amperes, 1.25. Typical operation and maximum ratings as class A₁ amplifier: plate volts, 135 (200 max); grid-No.2 (screen) volts, 135 max; plate dissipation, 12.5 max watts; grid-No.2 dissipation, 1.75 max watts; grid-No.1 (control-grid) volts, -13.5; plate ma., 58; grid-No.2 ma., 3.5; plate resistance, 9300 ohms; transconductance, 7000 μmhos; load resistance, 2000 ohms; maximum-signal output watts, 3.6. At maximum ratings, the 6Y6-G can deliver 6 watts output with load resistance of 2600 ohms.

RF POWER AMPLIFIER AND OSCILLATOR—Class C Telegraphy

Maximum Ratings:

DC PLATE VOLTAGE.....	350 max	volts
DC GRID-NO.2 VOLTAGE.....	135 max	volts
DC GRID-NO.1 VOLTAGE.....	-90 max	volts
DC PLATE CURRENT.....	80 max	ma
DC GRID-NO.1 CURRENT.....	1.5 max	ma
PLATE INPUT.....	23 max	watts
GRID-NO.2 INPUT.....	0.6 max	watt
PLATE DISSIPATION.....	8.0 max	watts

Typical Operation:

DC Plate Voltage.....	350	volts
DC Grid-No.2 Voltage*.....	115	volts
DC Grid-No.1 Voltage†.....	-40	volts
Peak RF Grid-No.1 Voltage.....	48	volts
DC Plate Current.....	60	ma
DC Grid-No.2 Current.....	5.1	ma
DC Grid-No.1 Current (Approx.).....	1.4	ma
Driving Power (Approx.).....	0.1	watt
Power Output (Approx.).....	14	watts

* Obtained from a separate source, from a potentiometer, or from plate supply through a series resistor of 45000 ohms.

† Obtained from fixed supply, by grid-No.1 resistor of 30000 ohms, by cathode resistor of 600 ohms, or by a combination of methods.

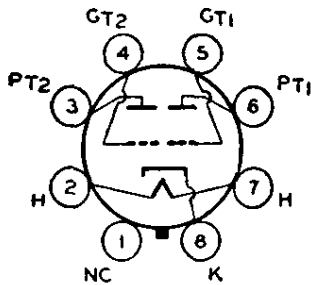

HIGH-MU TWIN POWER TRIODE

Glass octal type used as class B amplifier in output stage of radio receivers. Outline 24, OUTLINES SECTION. For electrical characteristics, refer to type 79. Heater volts (ac/dc), 6.3; amperes, 0.6. This is a DISCONTINUED type listed for reference only.

6Y7-G

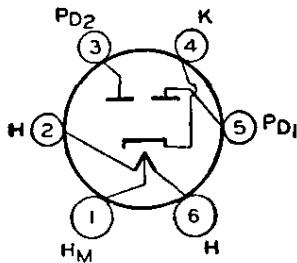

FULL-WAVE VACUUM RECTIFIER

Glass type used in power supply of radio receivers. Outline 25, OUTLINES SECTION. Heater volts (ac/dc), 12.6 in series heater arrangement and 6.3 in parallel arrangement; amperes, 0.4 (series), 0.8 (parallel). Maximum ac plate voltage per plate is 230 volts, and maximum dc output current is 60 ma. This is a DISCONTINUED type listed for reference only.

6Z5

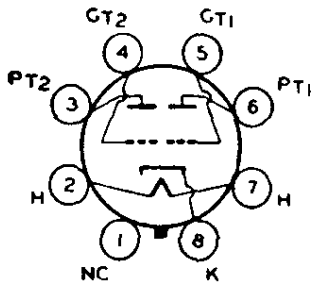

HIGH-MU TWIN POWER TRIODE

Glass octal type used as class B amplifier in output stage of radio receivers. Outline 24, OUTLINES SECTION. Tube requires octal socket. Heater volts (ac/dc), 6.3; amperes, 0.3. Typical operation and maximum ratings as class B power amplifier: plate volts, 180 max; grid volts, 0; peak plate ma. per plate, 60 max; average plate dissipation, 8 max watts; zero-signal plate ma. per plate, 4.2; plate-to-plate load resistance, 12000 ohms; output watts, 4.2 with average input of 320 milliwatts applied between grids. For typical operation as a resistance-coupled amplifier, refer to Chart 21, RESISTANCE-COUPLED AMPLIFIER SECTION. This type is used principally for renewal purposes.

6Z7-G

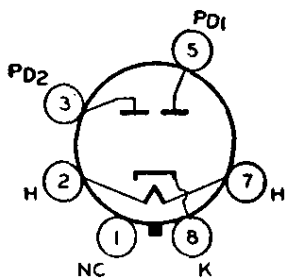

FULL-WAVE VACUUM RECTIFIER

Glass octal type used in power supply of radio equipment where economy of power is important. Outline 24, OUTLINES SECTION. Tube requires octal socket and may be mounted in any position. Heater volts (ac/dc), 6.3; amperes, 0.3. Maximum ratings: peak inverse plate volts, 1250; peak plate ma. per plate, 120; dc output ma., 40; peak heater-cathode volts, 450.

6ZY5-G

Typical Operation:

FULL-WAVE RECTIFIER

Filter Input	Capacitor	Choke	
AC Plate-to-Plate Supply Voltage (RMS).....	650	900	volts
Filter Input Capacitor.....	4	-	μf
Min. Total Effective Plate-Supply Impedance per Plate†.....	225	-	ohms
Min. Filter-Input Choke.....	-	13.5	henries
DC Output Current.....	40	40	ma

† When a filter-input capacitor larger than 4 μf is used, it may be necessary to use more plate-supply impedance than the minimum value shown to limit the peak plate current to the rated value.

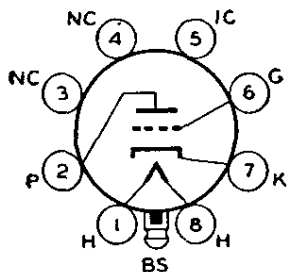

MEDIUM-MU TRIODE

Glass lock-in type used as detector, amplifier, or oscillator in radio equipment. Outline 12, OUTLINES SECTION. Tube requires lock-in socket. Heater volts (ac/dc), 6.3; amperes, 0.3. Maximum ratings, typical operating conditions, and curves for type 7A4 are the same as for metal type 6J5.

7A4

BEAM POWER AMPLIFIER

7A5

Glass lock-in type used as output amplifier in radio receivers in which the plate voltage available for the output stage is relatively low. Outline 15, OUTLINES SECTION. Tube requires lock-in socket. Heater volts (ac/dc), 6.3; amperes, 0.75. Typical operation and maximum ratings as class A₁ amplifier: plate volts, 125 *max*; grid-No.2 volts, 125 *max*; plate dissipation, 5.5 *max* watts; grid-No.2 dissipation, 1.2 *max* watts; grid-No.1 volts, -9; plate ma., 44; grid-No.2 ma., 3.3; plate resistance, 17000 ohms; transconductance, 6000 μ mhos; load resistance, 2700 ohms; maximum-signal output watts, 2.2.

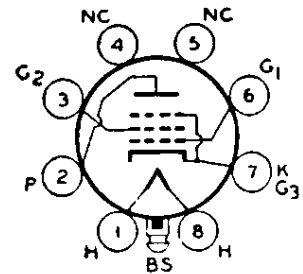

TWIN DIODE

7A6

Glass lock-in type used as detector, low-voltage rectifier, or avc tube. Outline 12, OUTLINES SECTION. Tube requires lock-in socket. Heater volts (ac/dc), 6.3; amperes, 0.15. Maximum ratings as rectifier: ac plate volts per plate (RMS), 150; dc output ma. per plate, 8; peak ma. per plate, 45; peak heater-cathode volts, 330. The application of this type is similar to that of metal type 6H6.

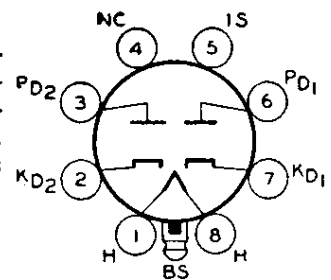

REMOTE-CUTOFF PENTODE

7A7

Glass lock-in type used as rf or if amplifier in radio receivers. Outline 12, OUTLINES SECTION. Tube requires lock-in socket. Heater volts (ac/dc), 6.3; amperes, 0.3. For maximum ratings, typical operation, and curves, refer to metal type 6SK7.

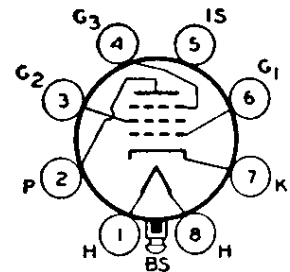

OCTODE CONVERTER

7A8

Glass lock-in type used as converter in superheterodyne circuits. Outline 12, OUTLINES SECTION. Tube requires lock-in socket. Heater volts (ac/dc), 6.3; amperes, 0.15. Typical operation and maximum ratings as frequency converter: plate volts, 250 (300 *max*); grids-No.3-and-No.5 volts, 100 *max*; grid-No.2 supply volts, 250 (300 *max*) applied through

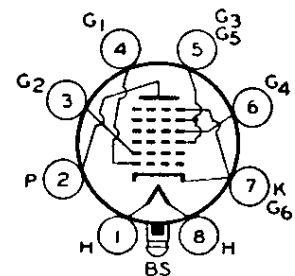

20000-ohm dropping resistor properly bypassed; grid-No.2 volts, 165 (200 *max*); plate dissipation, 1 *max* watt; grids-No.3-and-No.5 dissipation, 0.3 *max* watt; grid-No.2 dissipation, 0.75 *max* watt; grid-No.4 volts, -3 (0 *min*); grid-No.1 resistor, 50000 ohms; plate ma., 3; grids-No.3-and-No.5 ma., 3.2; grid-No.2 ma., 4.2; grid-No.1 ma., 0.4; plate resistance, 0.7 megohm; conversion transconductance, 550 μ mhos; conversion transconductance with grid-No.1 bias of -30 volts, 2 μ mhos. The application of this type is similar to that of metal type 6A8 and glass-octal type 6D8-G.

HIGH-MU TRIODE

7B4

Glass lock-in type used in resistance-coupled amplifier circuits. Outline 12, OUTLINES SECTION. Tube requires lock-in socket. Heater volts (ac/dc), 6.3; amperes, 0.3. Except for interelectrode capacitances, this type has the same maximum ratings and characteristics as metal types 6F5 and 6SF5.

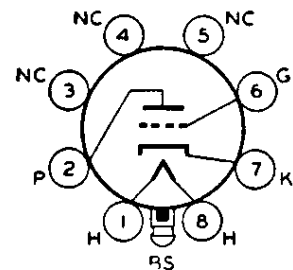

POWER PENTODE

7B5

Glass lock-in type used in output stage of radio receivers. Outline 15, OUTLINES SECTION. Tube requires lock-in socket. Heater volts (ac/dc), 6.3; amperes, 0.4. Except for interelectrode capacitances, this type is the same electrically as glass-octal type 6K6-GT.

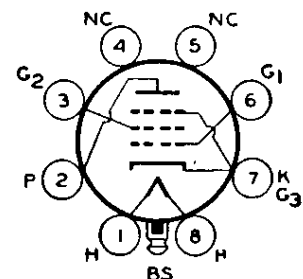

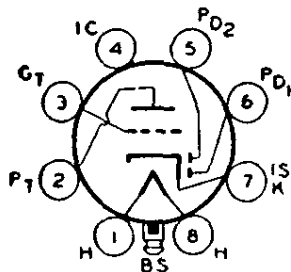

TWIN DIODE—HIGH-MU TRIODE

Glass lock-in type used as combined detector, amplifier, and avc tube. Outline 12, OUTLINES SECTION. Tube requires lock-in socket. Heater volts (ac/dc), 6.3; amperes, 0.3. Except for interelectrode capacitances, this type is the same electrically as metal type 6SQ7.

7B6

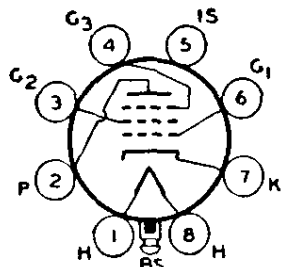

REMOTE-CUTOFF PENTODE

Glass lock-in type used as rf or if amplifier in radio receivers employing avc. Outline 12, OUTLINES SECTION. Tube requires lock-in socket. Heater volts (ac/dc), 6.3; amperes, 0.15. Typical operation as class A₁ amplifier: plate volts, 250 (300 max); grid-No.2 volts, 100 max; grid-No.1 volts, -3; grid No.3 connected to cathode at socket; plate ma., 8.5; grid-No.2

7B7

ma., 1.7; plate resistance, 0.75 megohm; transconductance, 1750 μmhos; transconductance at bias of -40 volts, 10 μmhos. The application of this type is similar to that of metal types 6SK7 and 6SS7.

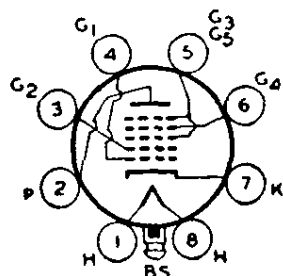

PENTAGRID CONVERTER

Glass lock-in type used as frequency converter in superheterodyne circuits. Outline 12, OUTLINES SECTION. Tube requires lock-in socket. Heater volts (ac/dc), 6.3; amperes, 0.3. Except for interelectrode capacitances, this type is the same electrically as metal type 6A8.

7B8

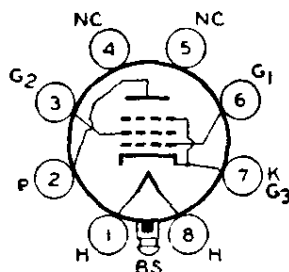

BEAM POWER AMPLIFIER

Glass lock-in type used as output amplifier in radio receivers. Outline 15, OUTLINES SECTION. Tube requires lock-in socket. Heater volts (ac/dc), 6.3; amperes, 0.45. Refer to metal type 6V6 for maximum ratings and typical operation as single-tube class A₁ amplifier and as push-pull amplifier, and for curves, to miniature type 6AQ5.

7C5

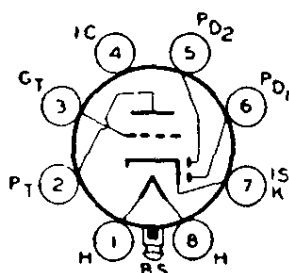

TWIN DIODE—HIGH-MU TRIODE

Glass lock-in type used as combined detector, amplifier, and avc tube. Outline 12, OUTLINES SECTION. Tube requires lock-in socket. Heater volts (ac/dc), 6.3; amperes, 0.15. Typical operation of triode unit as class A₁ amplifier: plate volts, 250 (300 max); grid volts, -1; plate ma., 1.3; plate resistance, 0.1 megohm; transconductance, 1000 μmhos. For diode operation curves and triode application, refer to metal type 6SQ7.

7C6

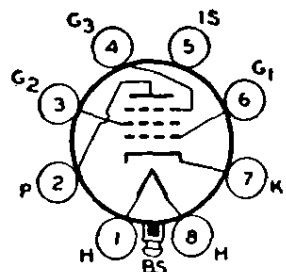

SHARP-CUTOFF PENTODE

Glass lock-in type used as biased detector or rf amplifier. Outline 12, OUTLINES SECTION. Tube requires lock-in socket. Heater volts (ac/dc), 6.3; amperes, 0.15. Typical operation as class A₁ amplifier: plate volts, 250 (300 max); grid-No.2 volts, 100 max; grid-No.1 volts, -3 (0 min); grid No.3 and internal shield connected to cathode at socket; plate resistance

7C7

(approx.), 2 megohms; plate ma., 2; grid-No.2 ma., 0.5; transconductance, 1300 μmhos. The application of this type is similar to that of metal type 6SJ7 and glass-octal type 6W7-G.

KINESCOPE

7DP4

Directly viewed picture tube used in television receivers. Features a white fluorescent screen having medium persistence and high efficiency. Utilizes electrostatic focusing and magnetic deflection to provide a picture of about 4 by 5-1/2 inches. Has solid deflection angle of 50° approx. Maximum bulb diameter is 7-5/16 inches; maximum overall length, 14-7/16 inches. Outline 38, OUTLINES SECTION. Tube has small-shell duodecal 7-pin base and recessed small cavity cap.

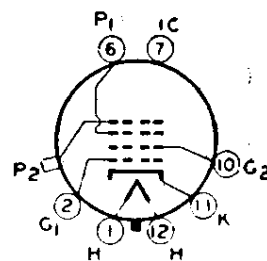

HEATER VOLTAGE (AC/DC).....	6.3	volts
HEATER CURRENT.....	0.6	ampere
DIRECT INTERELECTRODE CAPACITANCES (Approx.):		
Grid No.1 to All Other Electrodes.....	6.5	μμf
Cathode to All Other Electrodes.....	5.0	μμf
External Conductive Coating to Anode No.2.....	{ 1500 max	μμf
	{ 400 max	μμf

Maximum Ratings:

ANODE-NO.2 VOLTAGE.....	8000 max	volts
ANODE-NO.1 VOLTAGE.....	2400 max	volts
GRID-NO.2 VOLTAGE.....	410 max	volts
GRID-NO.1 VOLTAGE:		
Negative bias value.....	125 max	volts
Positive bias value.....	0 max	volts
Positive peak value.....	2 max	volts
PEAK HEATER-CATHODE VOLTAGE:		
Heater negative with respect to cathode.....	125 max	volts
Heater positive with request to cathode.....	125 max	volts

Typical Operation:

Anode-No.2 Voltage*.....	6000	volts
Anode-No.1 Voltage for Focus°.....	1430	volts
Grid-No.2 Voltage.....	250	volts
Grid-No.1 Voltage**.....	-45	volts
Ion-Trap-Magnet Current (DC) +.....	70	ma
Horizontal Deflecting-Coil Current (DC) ∞.....	410	ma
Maximum Anode-No.1 Current Range.....	-15 to +10	μa

Maximum Circuit Values:

Grid-No.1-Circuit Resistance.....	1.5 max	megohms
-----------------------------------	---------	---------

* Brilliance and definition decrease with decreasing anode-No.2 voltage. In general, anode-No.2 voltage should not be less than 5000 volts.

° With the combined grid-No.1-bias voltage and video-signal voltage adjusted to produce a highlight brightness of 12 foot-lamberts on a 4" x 5 1/2" picture area. The anode-No.1 voltage supply should be adjustable to ± 15% of indicated value.

** Visual extinction of undeflected focused spot. Supply should be adjustable to ± 40% of indicated value.

+ For RCA Ion-Trap Magnet, RCA Type No. 203D1, or equivalent.

∞ To deflect beam from side to side of a raster 5 1/2" wide with RCA Deflection Yoke, RCA Type No. 201D1, or equivalent. Coil current varies directly as the square root of the anode-No.2 voltage.

INSTALLATION AND APPLICATION

The base pins of the 7DP4 fit the duodecal socket and the tube may be mounted in any position. The socket, however, should not be used to support the tube but should have flexible leads and be allowed to move freely. The tube should be supported by a padded ring around the bulb cone adjacent to the neck and by a cushioned ring or other arrangement near the screen end.

Do not strike or scratch the tube or subject it to more than moderate pressure when it is being placed into or removed from its mounting. All kinescopes are evacuated and in case of breakage, injury from flying glass may result.

In the use of cathode-ray tubes, it should always be remembered that high voltages may appear at normally low-potential points in the circuit due to capacitor breakdown or to incorrect circuit connections. Therefore, before any part of the circuit is touched, the power-supply switch should be turned off and both terminals of any charged capacitors grounded.

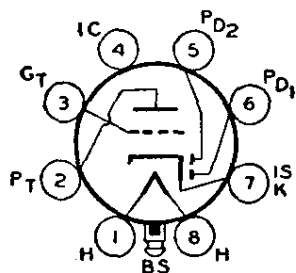

TWIN DIODE—MEDIUM-MU TRIODE

Glass lock-in type used as combined detector, amplifier, and avc tube. Outline 12, OUTLINES SECTION. Tube requires lock-in socket. Heater volts (ac/dc), 6.3; amperes, 0.3. For maximum ratings, typical operation, and curves, refer to miniature type 6BF6.

7E6

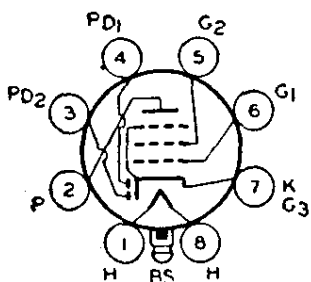

TWIN DIODE—REMOTE-CUTOFF PENTODE

Glass lock-in type used as combined detector, amplifier, and avc tube. Outline 12, OUTLINES SECTION. Tube requires lock-in socket. Heater volts (ac/dc), 6.3; amperes, 0.3. Typical operation and maximum ratings of pentode unit as class A₁ amplifier: plate volts, 250 max; grid-No.2 volts, 100 max; plate dissipation, 2 max watts; grid-No.2 dissipation, 0.3

7E7

max watt; grid-No.1 volts, -3 (0 min); plate resistance (approx.), 0.7 megohm; transconductance, 1300 μmhos; grid-No.1 volts for transconductance of 2 μmhos, -42.5; plate ma., 7.5; grid-No.2 ma., 1.6. For diode operation curves, refer to type 6SQ7.

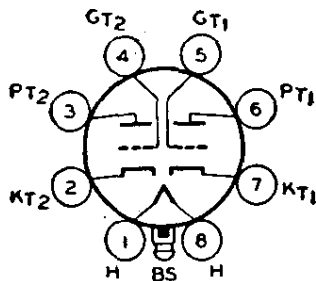

HIGH-MU TWIN TRIODE

Glass lock-in type used as phase inverter or resistance-coupled amplifier. Outline 12, OUTLINES SECTION. Tube requires lock-in socket. Heater volts (ac/dc), 6.3; amperes, 0.3. For maximum ratings, typical operation as class A₁ amplifier, and curves, refer to glass-octal type 6SL7-GT.

7F7

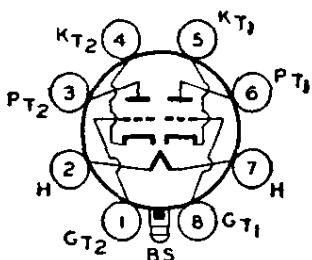

MEDIUM-MU TWIN TRIODE

Glass lock-in type used as a amplifier or oscillator in radio equipment. Except for overall length of 2-9/32 inches and seated height of 1 3/4 inches, the dimensions of type 7F8 are given by Outline 12, OUTLINES SECTION. Tube requires lock-in socket. Heater volts (ac/dc), 6.3; amperes, 0.3. Typical operation and maximum ratings as class A₁ amplifier (per unit): plate

7F8

volts, 250 (300 max); cathode resistor, 500 ohms; plate ma., 6.0; transconductance, 3300 μmhos; amplification factor, 48; grid volts for plate current of 10 μa., -11; grid-circuit resistor, 0.5 max megohm.

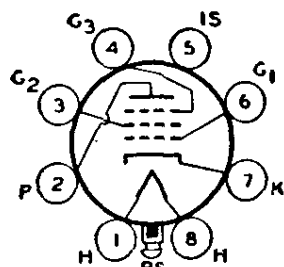

SHARP-CUTOFF PENTODE

Glass lock-in type used in video amplifiers of television receivers and in other applications requiring high transconductance. Outline 12, OUTLINES SECTION. Tube requires lock-in socket. Heater volts (ac/dc), 6.3; amperes, 0.45. Typical operation and maximum ratings as class A₁ amplifier: plate volts, 250 (300 max); grid-No.2 volts, 100 max; plate dissipation, 1.5

**7G7/
1232**

max watts; grid-No.2 dissipation, 0.3 max watt; grid-No.1 volts, -2; grid No.3 and internal shield connected to cathode at socket; plate resistance (approx.), 0.8 megohm; transconductance, 4500 μmhos; grid-No.1 volts for cathode-current cutoff, -7; plate ma., 6; grid-No.2 ma., 2.0. The application of this type is similar to that of miniature type 6AU6.

KINESCOPE

7GP4

Directly viewed picture tube used in television receivers. Features a white fluorescent screen and utilizes electrostatic focus and deflection to provide a picture about 4 by 5½ inches. Tube has medium-shell diheptal 12-pin base. Except for base connections and within its maximum ratings (anode-No.2 and grid-No.2 volts, 4000 *max*; anode-No.1 volts, 1500 *max*),

this type is identical with type 7JP4. The 7JP4 may be used to replace the 7GP4 provided no connections are made to pins 4 and 12. The 7GP4 is a DISCONTINUED type listed for reference only.

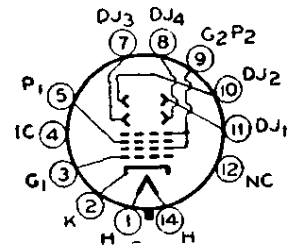

REMOTE-CUTOFF PENTODE

7H7

Glass lock-in type used as rf or if amplifier in radio receivers. Outline 12, OUTLINES SECTION. Tube requires lock-in socket. Heater volts (ac/dc), 6.3; amperes, 0.3. Typical operation and maximum ratings as class A₁ amplifier: plate volts, 250 (300 *max*); grid-No.2 volts, 150 *max*; plate dissipation, 2.5 *max* watts; grid-No.2 dissipation, 0.5 *max* watt; grid-No.1

volts, -2.5 (0 *min*); grid No.3 and internal shield connected to cathode at socket; plate resistance (approx.), 0.8 megohm; transconductance, 3800 μmhos; grid-No.1 volts for transconductance of 35 μmhos, -19; plate ma., 9.5; grid-No.2 ma., 3.5. The application of this type is similar to that of miniature type 6BA6.

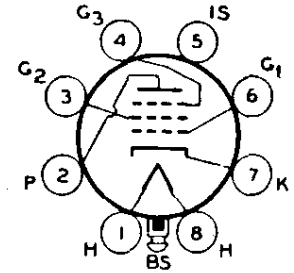

TRIODE—HEPTODE CONVERTER

7J7

Glass lock-in type used as combined oscillator and heptode mixer in radio receivers. Outline 12, OUTLINES SECTION. Tube requires lock-in socket. Heater volts (ac/dc), 6.3; amperes, 0.3. For maximum ratings and typical operation, refer to glass-octal type 6J8-G.

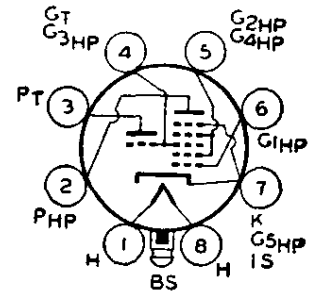

KINESCOPE

7JP4

Directly viewed picture tube used in television receivers and in oscillograph equipment. Features a white fluorescent screen having high efficiency. It utilizes electrostatic focus and deflection to provide a picture of about 4 by 5½ inches. Maximum bulb

diameter is 7-⅛ inches; maximum overall length is 14-⅞ inches. Outline 39, OUTLINES SECTION. Tube has medium-shell diheptal 12-pin base.

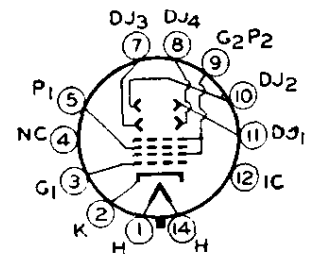

HEATER VOLTAGE (AC/DC)	6.3	volts
HEATER CURRENT	0.6	ampere
DIRECT INTERELECTRODE CAPACITANCES (Approx.):		
Grid No.1 to All Other Electrodes	8.5	μf
Cathode to All Other Electrodes	9.5	μf
DJ ₁ to DJ ₂	3.5	μf
DJ ₃ to DJ ₄	2.0	μf
DJ ₁ to All Other Electrodes	11.0	μf
DJ ₂ to All Other Electrodes	11.0	μf
DJ ₃ to All Other Electrodes	8.0	μf
DJ ₄ to All Other Electrodes	8.0	μf
Maximum Ratings:		
ANODE-NO.2 AND GRID-NO.2 VOLTAGE	6000 <i>max</i>	volts
ANODE-NO.1 VOLTAGE	2800 <i>max</i>	volts
GRID-NO.1 VOLTAGE: •		
Negative bias value	200 <i>max</i>	volts
Positive bias value ‡	0 <i>max</i>	volts
Peak positive value	2 <i>max</i>	volts
PEAK VOLTAGE BETWEEN ANODE NO.2 AND ANY DEFLECTING ELECTRODE ..	750 <i>max</i>	volts
PEAK HEATER-CATHODE VOLTAGE:		
Heater negative with respect to cathode	125 <i>max</i>	volts
Heater positive with respect to cathode:		
During equipment warm-up period not exceeding 15 seconds	410 <i>max</i>	volts
After equipment warm-up period	125 <i>max</i>	volts

Typical Operation:

Anode-No.2 Voltage*	4000	6000	volts
Anode-No.1 Voltage for Focus°	1340	2000	volts
Grid-No.1 Voltage **	-80	-120	volts
Maximum Anode-No.1 Current Range	-15 to +10	-15 to +10	μ a
Deflection Factors:			
DJ ₁ and DJ ₂	144	216	volts dc/in
DJ ₃ and DJ ₄	118	177	volts dc/in

Maximum Circuit Values:

Grid-No.1-Circuit Resistance	1.5 max	megohms
Resistance in any Deflecting-Electrode Circuit†	5.0 max	megohms

† For operation with 0 volts on grid No.1 and with 4000 to 6000 volts on anode No.2, it is essential that the effective resistance of the anode-No.2 supply be adequate to limit the anode-No.2 input power to 6 watts.

* Brilliance and definition decrease with decreasing anode-No.2 voltage.

° With the combined grid-No.1-bias voltage and video-signal voltage adjusted for a highlight brightness of 12 foot-lamberts on a 4" x 5½" picture area. The anode-No.1 voltage should be adjusted to ± 20% of indicated value.

** Visual extinction of undeflected focused spot. Supply should be adjustable to ± 40% of indicated value.

† It is recommended that the deflecting-electrode-circuit resistances be approximately equal.

INSTALLATION AND APPLICATION

The base pins of the 7JP4 fit the diheptal socket and the tube may be mounted in any position. The socket, however, should not be used to support the tube but should have flexible leads and be allowed to move freely. The tube should be supported by a padded mechanism about the neck and by a cushioned ring or other arrangement near the screen end.

DJ₁ and DJ₂ are nearer the screen; DJ₃ and DJ₄ are nearer the base. When DJ₁ is positive with respect to DJ₂, the spot is deflected toward pin 5; when DJ₁ is positive with respect to DJ₄, the spot is deflected toward pin 2.

Do not strike or scratch the tube or subject it to more than moderate pressure when it is being placed into or removed from its mounting. All kinescopes are evacuated and in case of breakage, injury from flying glass may result.

In the use of cathode-ray tubes, it should always be remembered that high voltages may appear at normally low-potential points in the circuit due to capacitor breakdown or to incorrect circuit connections. Therefore, before any part of the circuit is touched, the power-supply switch should be turned off and both terminals of any charged capacitors grounded.

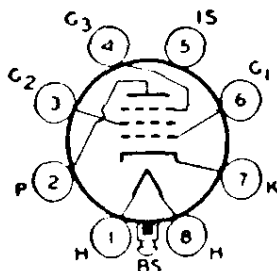

SHARP-CUTOFF PENTODE

Glass lock-in type used as rf and if amplifier in radio equipment. Outline 12, OUTLINES SECTION. Tube requires lock-in socket. Heater volts (ac/dc), 6.3; amperes, 0.3. Typical operation and maximum ratings as class A₁ amplifier: plate volts, 250 (300 max); grid-No.2 volts, 100 (125 max); grid-No.1 volts, -1.5; grid No.3 tied to cathode at socket; cathode

7L7

resistor, 250 ohms; plate ma., 4.5; grid-No.2 ma., 1.5; plate resistance (approx.), 1 megohm; transconductance, 3100 μ mhos. The application of this type is similar to that of miniature type 6AU6.

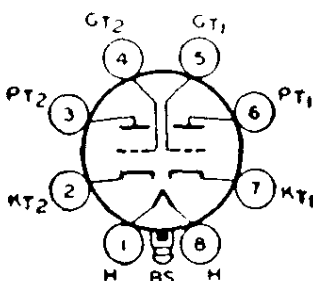

MEDIUM-MU TWIN TRIODE

Glass lock-in type used as voltage amplifier or phase inverter in radio equipment. Outline 15, OUTLINES SECTION. Tube requires lock-in socket. Heater volts (ac/dc), 6.3; amperes, 0.6. For maximum ratings and typical operation of each triode unit, refer to metal type 6J5. The application of this type is similar to that of glass-octal type 6SN7-GT.

7N7

PENTAGRID CONVERTER

7Q7

Glass lock-in type used as converter in superheterodyne circuits. Outline 12, OUTLINES SECTION. Tube requires lock-in socket. Heater volts (ac/dc), 6.3; amperes, 0.3. For maximum ratings, typical operation in converter service, and curves, refer to metal type 6SA7.

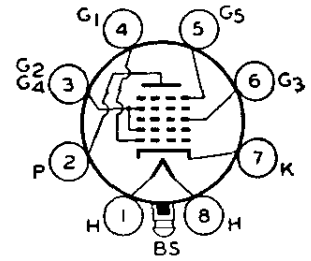

TWIN DIODE—REMOTE-CUTOFF PENTODE

7R7

Glass lock-in type used as combined detector, amplifier, and avc tube. Outline 12, OUTLINES SECTION. Tube requires lock-in socket. Heater volts (ac/dc), 6.3; amperes, 0.3. Typical operation and ratings of pentode unit as class A₁ amplifier: plate volts, 250 (300 max); grid-No.2 volts, 100 max; plate dissipation, 2 max watts; grid-No.2 dissipation, 0.25 max watt;

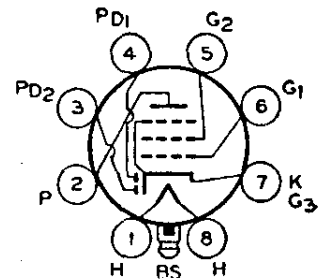

grid-No.1 volts, -1 (0 min); plate resistance (approx.), 1.0 megohm; transconductance, 3400 μmhos; plate ma., 6.2; grid-No.2 ma., 1.6, grid-No.1 volts for transconductance of 2 μmhos, -20. Refer to type 6SQ7 for diode operation curves.

TRIODE—HEPTODE CONVERTER

7S7

Glass lock-in type used as combined triode oscillator and heptode mixer in radio receivers. Outline 12, OUTLINES SECTION. Tube requires lock-in socket. Heater volts (ac/dc), 6.3; amperes, 0.3. Typical operation of heptode unit: plate volts, 250 (300 max); grids-No.2-and-No.4 volts, 100 max; grid-No.1 volts, -2; plate resistance, 1.25 megohms; conversion transcon-

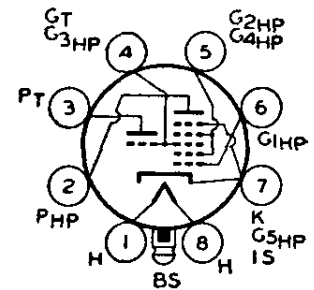

ductance, 525 μmhos; plate ma., 1.8; grids-No.2-and-No.4 ma., 3.0. Typical operation of triode unit: plate supply volts, 250 (300 max) applied through a 20000-ohm dropping resistor bypassed by a 0.1-μf capacitor; grid resistor, 50000 ohms; plate ma., 5.0; total cathode ma. (both units), 10.2.

SHARP-CUTOFF PENTODE

7V7

Glass lock-in type used as rf or if amplifier in radio receivers. Outline 12, OUTLINES SECTION. Tube requires lock-in socket. Heater volts (ac/dc), 6.3; amperes, 0.45. Typical operation and maximum ratings as class A₁ amplifier: plate volts and grid-No.2 supply volts, 300 max; grid-No.2 series resistor, 40000 ohms; plate dissipation, 4 max watts; grid-No.2 dissipation,

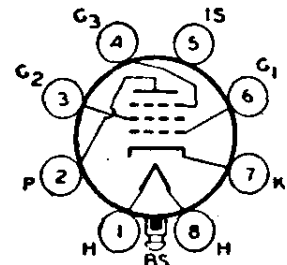

0.8 max watt; grid No.3 connected to cathode at socket; cathode-bias resistor, 160 min ohms; plate resistance, 0.3 megohm; transconductance, 5800 μmhos; plate ma., 10; grid-No.2 ma., 3.9; grid-No.1 volts for plate current of 10 μa., -16. The application of this type is similar to that of miniature type 6AU6.

SHARP-CUTOFF PENTODE

7W7

Glass lock-in type used as rf or if amplifier in radio receivers. Outline 12, OUTLINES SECTION. Tube requires lock-in socket. Heater volts (ac/dc), 6.3; amperes, 0.45. This type is the same as type 7V7 except for socket connections.

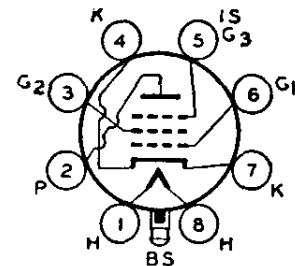

FULL-WAVE VACUUM RECTIFIER

7Y4

Glass lock-in type used in power supply of automobile radio receivers and compact ac-operated receivers. Outline 12, OUTLINES SECTION. Tube requires lock-in socket. Heater volts (ac/dc), 6.3; amperes, 0.5. Maximum ratings: peak inverse plate volts, 1250; peak plate ma. per plate, 180; dc output ma., 70; peak heater-cathode volts, 450. For typical operation, refer to miniature type 6X4.

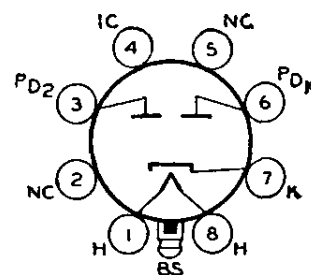

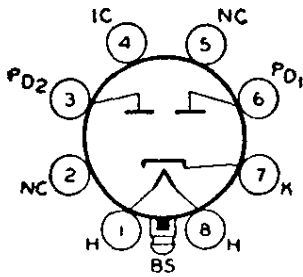

FULL-WAVE VACUUM RECTIFIER

Glass lock-in type used in power supply of automobile and ac-operated radio receivers. Outline 15, OUTLINES SECTION. Tube requires lock-in socket. Heater volts (ac/dc), 6.3; amperes, 0.9. Maximum ratings: peak inverse plate volts, 1250; peak plate ma. per plate, 300; dc output ma., 100; peak heater-cathode volts, 450.

7Z4

Typical Operation:
Filter Input

FULL-WAVE RECTIFIER

	Capacitor	Choke	
AC Plate-to-Plate Supply Voltage (RMS).....	650	900	volts
Filter-Input Capacitor.....	4	-	μ f
Min. Total Effective Plate-Supply Impedance per Plate†.....	75	-	ohms
Min. Filter-Input Choke.....	-	6	henries
DC Output Current.....	100	100	ma

† When a filter capacitor larger than 4 μ f is used, it may be necessary to use more plate-supply impedance than the minimum value shown to limit the peak plate current to the rated value.

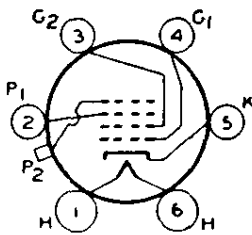

KINESCOPE

Directly viewed picture tube used in television receivers. Features a white fluorescent screen having medium persistence and high efficiency. It utilizes electrostatic focus and magnetic deflection to provide a picture about 5-3/8 by 7-1/4 inches. Maximum diameter is 9-1/8 inches; maximum overall length is 21-3/8 inches. Tube requires six-contact socket. Refer to type

9AP4

12AP4 for maximum ratings, characteristics, and typical operation. For handling and safety considerations, refer to type 10BP4. This type is used only for renewal purposes.

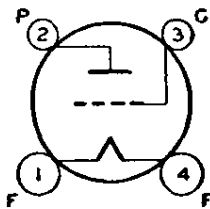

POWER TRIODE

Glass type used as an audio-frequency amplifier. Outline 34, OUTLINES SECTION. Tube requires four-contact socket and should be operated in vertical position with base down. Filament volts (ac/dc), 7.5; amperes, 1.25. Typical operation as class A₁ af power amplifier: plate volts, 425 max; grid volts, -40; peak af grid volts, 35; plate ma., 18; plate resistance,

10

5000 ohms; transconductance, 1600 μ mhos; load resistance, 10200 ohms; undistorted output watts, 1.6. This type is used principally for renewal purposes.

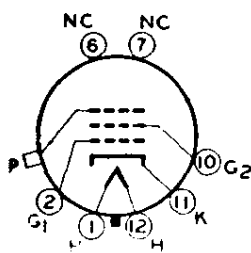

KINESCOPE

Directly viewed picture tube used in television receivers. Features a white fluorescent screen having medium persistence and high efficiency. It utilizes magnetic focus and magnetic deflection to provide a picture about 6 by 8

10BP4

inches. Maximum diameter is 10-5/8 inches; maximum overall length is 18 inches. Outline 40, OUTLINES SECTION. Provided with a small-shell duodecal 7-pin base and a recessed small cavity cap.

HEATER VOLTAGE (AC/DC).....	6.3	volts
HEATER CURRENT.....	0.6	ampere
DIRECT INTERELECTRODE CAPACITANCES (Approx.):		
Grid No.1 to All Other Electrodes.....	6.5	μ f
Cathode to All Other Electrodes.....	5.0	μ f
External Conductive Coating to Anode No.2.....	{ 2500 max 500 min	{ μ f μ f
Maximum Ratings:		
ANODE VOLTAGE.....	10000 max	volts
GRID-NO.2 VOLTAGE.....	410 max	volts
GRID-NO.1 VOLTAGE:		
Negative bias value.....	125 max	volts
Positive bias value.....	0 max	volts
Positive peak value.....	2 max	volts
PEAK HEATER-CATHODE VOLTAGE:		
Heater negative with respect to cathode.....	125 max	volts
Heater positive with respect to cathode.....	125 max	volts

Typical Operation:

Anode Voltage*	9000	volts
Grid-No.2 Voltage	250	volts
Grid-No.1 Voltage°	-45	volts
Focusing-Coil Current (DC Approx.)**	115	ma
Ion-Trap-Magnet Current (DC Approx.)#	109	ma
Horizontal Deflecting-Coil Current (DC Approx.)†	470	ma

Maximum Circuit Values:

Grid-No.1-Circuit Resistance	1.5 max megohms
--	-----------------

* Brilliance and definition decrease with decreasing anode voltage. In general, the anode voltage should not be less than 8000 volts.

° Visual extinction of undeflected focused spot. Supply should be adjustable to $\pm 40\%$ of indicated value.

** For RCA Focusing Coil, RCA Type No.202D1, or equivalent, with the combined grid-No.1-bias voltage and signal voltage adjusted to produce a highlight brightness of 20 foot-lamberts on a 6" x 8" picture area.

For RCA Ion-Trap Magnet, RCA Type No.203D1, or equivalent.

† To deflect beam from side to side of a raster 8" wide with RCA Deflection Yoke, RCA Type No.201D1, or equivalent. Coil current varies directly as the square root of the anode voltage.

INSTALLATION AND APPLICATION

The base pins of the 10BP4 fit the duodecal socket and the tube may be mounted in any position. The socket, however, should not be used to support the tube, but should have flexible leads and be allowed to move freely. The tube should be supported by a padded ring around the bulb cone adjacent to the neck and by a cushioned ring or other arrangement near the screen end.

Do not strike or scratch the tube or subject it to more than moderate pressure when it is being placed into or removed from its mounting. All kinescopes are evacuated and in case of breakage, injury from flying glass may result.

In the use of cathode-ray tubes, it should always be remembered that high voltages may appear at normally low-potential points in the circuit due to capacitor breakdown or to incorrect circuit connections. Therefore, before any part of the circuit is touched, the power-supply switch-should be turned off and both terminals of any charged capacitors grounded.

11

DETECTOR AMPLIFIER

Glass types used as detectors and amplifiers in battery-operated receivers. Filament volts (dc), 1.1; amperes, 0.25. Typical operation as class A₁ amplifier: plate volts, 135 max; grid volts, -10.5; plate resistance, 15500 ohms; transconductance, 440 μ mhos; plate ma., 3. These are DISCONTINUED types listed for reference only.

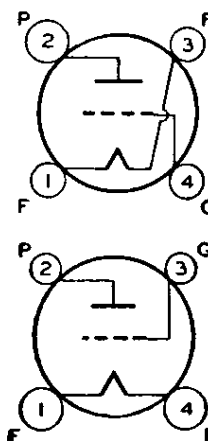

12

POWER PENTODE

12A5

Glass type used as output amplifier in ac/dc radio receivers. Outline 25, OUTLINES SECTION. Heater volts (ac/dc), 12.6 in series heater arrangement and 6.3 in parallel arrangement; amperes, 0.3 (series), 0.6 (parallel). Typical operation as class A₁ amplifier: plate volts and grid-No.2 volts, 180 max; grid-No.1 volts, -25; plate ma., 45; grid-No.2 ma., 8; plate resistance, 35000 ohms; transconductance, 2400 μ mhos; load resistance, 3300 ohms; output watts, 3.4. This is a DISCONTINUED type listed for reference only.

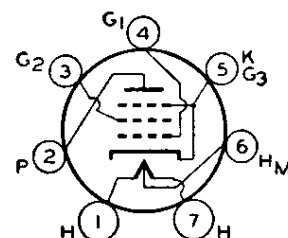

This is a DISCONTINUED type listed for reference only.

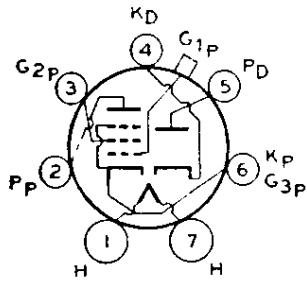

RECTIFIER—POWER PENTODE

12A7

Glass type used as combined half-wave rectifier and power amplifier. Outline 27, OUTLINES SECTION. Tube requires small seven-contact (0.75-inch, pin-circle diameter) socket. Heater volts (ac/dc), 12.6; amperes, 0.3. Typical operation of pentode unit as class A₁ amplifier: plate volts and grid-No.2 volts, 135 max; grid-No.1 volts, -13.5; load resistance, 13500

ohms; plate resistance, 100000 ohms; transconductance, 975 μmhos; cathode resistance, 1175 ohms; plate ma., 9; grid-No.2 ma., 2.5; output watts, 0.55. Maximum ratings of rectifier unit with capacitor-input filter: ac plate volts (RMS), 125; dc output ma., 30. This type is used principally for renewal purposes.

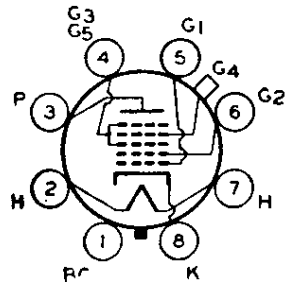

PENTAGRID CONVERTER

12A8-GT

Glass octal type used as converter in ac/dc receivers. Outline 18, OUTLINES SECTION. Heater volts (ac/dc), 12.6; amperes, 0.15. Except for heater rating, this type is identical with glass-octal type 6A8-GT.

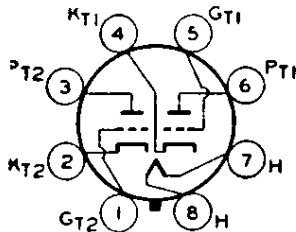

MEDIUM-MU TWIN TRIODE

12AH7-GT

Glass octal tube used as audio amplifier in radio equipment. Outline 14, OUTLINES SECTION. Tube requires octal socket. Heater volts (ac/dc), 12.6; amperes, 0.15. Typical operation as class A₁ amplifier: plate volts, 180 max; grid volts, -6.5; amplification factor, 16; transconductance, 1900 μmhos; plate resistance, 8400 ohms; plate ma., 7.6; grid-bias volts for plate current of 10 μa, -16.

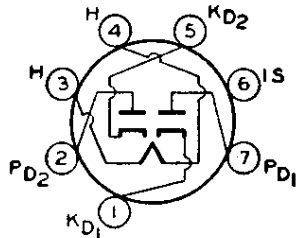

TWIN DIODE

12AL5

Miniature, high-perveance type used as detector in FM and television circuits. It is especially useful as a ratio detector in ac/dc FM receivers. Outline 8, OUTLINES SECTION.

Heater volts (ac/dc), 12.6; amperes, 0.15. Except for heater rating, this type is identical with miniature type 6AL5.

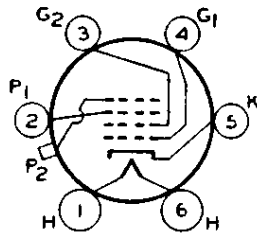

KINESCOPE

12AP4

Directly viewed picture tube used in television receivers. Features white fluorescent screen having medium persistence and high efficiency. It utilizes electrostatic focus and magnetic deflection to provide a picture about 7 3/8 by 9 3/4 inches. Maximum diameter is 12-3/16 inches; maximum overall length is 25-3/8 inches. Tube requires six-contact socket. For

handling and safety considerations, refer to type 10BP4. This type is used only for renewal purposes.

HEATER VOLTAGE (AC/DC).....	2.5	volts
HEATER CURRENT.....	2.1	amperes
DIRECT INTERELECTRODE CAPACITANCE:		
Grid No.1 to All Other Electrodes.....	9	μf
Maximum Ratings:		
ANODE-NO.2 VOLTAGE.....	7000 max	volts
ANODE-NO.1 VOLTAGE.....	2000 max	volts
GRID-NO.2 VOLTAGE.....	300 max	volts
GRID-NO.1 VOLTAGE:		
Negative bias value.....	125 max	volts
Positive bias value.....	0 max	volts
Positive peak value.....	2 max	volts

Typical Operation:

Anode-No.2 Voltage ¶	6000	7000	volts
Anode-No.1 Voltage*	1240	1460	volts
Grid-No.2 Voltage	250	250	volts
Grid-No.1 Voltage	-20 to -60	-20 to -60	volts
Grid-No.1 Signal-Swing Voltage ¶¶	25	25	volts

Maximum Circuit Values:

Grid-No.1-Circuit Resistance..... 5 max megohms

¶ Brilliance and definition decrease with decreasing anode-No.2 voltage. In general, anode-No.2 voltage should not be less than 6000 volts.

* Should be adjustable to $\pm 20\%$ of the values shown.

¶¶ Peak-to-peak value for good brilliance with good resolution. For greater brilliance, up to twice this value should be available.

TWIN DIODE— HIGH-MU TRIODE

12AT6

Miniature type used as a combined detector, amplifier, and avc tube in compact ac/dc radio receivers. Outline 10, OUTLINES SECTION. Heater volts (ac/dc), 12.6; amperes, 0.15. Except for the heater rating, this type is identical with miniature type 6AT6.

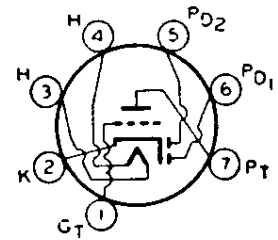

SHARP-CUTOFF PENTODE

12AU6

Miniature type used in compact ac/dc radio equipment as an rf amplifier especially in high-frequency, wide-band applications. Outline 10, OUTLINES SECTION. Heater volts (ac/dc), 12.6; amperes, 0.15. Except for heater rating, this type is identical with miniature type 6AU6.

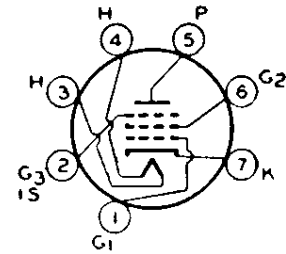

MEDIUM-MU TWIN TRIODE

12AU7

Miniature type used as phase inverter or amplifier in ac/dc radio equipment and in many diversified applications such as multivibrators or oscillators in industrial control de-

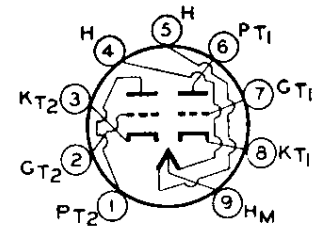

vices. Outline 11, OUTLINES SECTION. Tube requires noval nine-contact socket and may be mounted in any position. Its characteristics are similar to glass-octal type 6SN7-GT. Each triode unit is independent of the other except for the common heater. For typical operation as a resistance-coupled amplifier, refer to Chart 10, RESISTANCE-COUPLED AMPLIFIER SECTION.

HEATER ARRANGEMENT	<i>Series</i>	<i>Parallel</i>	
HEATER VOLTAGE (AC/DC).....	12.6	6.3	volts
HEATER CURRENT.....	0.15	0.3	ampere

DIRECT INTERELECTRODE CAPACITANCES (No external shield):

	<i>Triode Unit T₁</i>	<i>Triode Unit T₂</i>	
Grid to Plate.....	1.5	1.5	$\mu\mu\text{f}$
Grid to Cathode.....	1.6	1.6	$\mu\mu\text{f}$
Plate to Cathode.....	0.50	0.35	$\mu\mu\text{f}$

CLASS A₁ AMPLIFIER

Maximum Ratings:

PLATE VOLTAGE.....	300 <i>max</i>	volts
PLATE DISSIPATION.....	2.75 <i>max</i>	watts
CATHODE CURRENT.....	20 <i>max</i>	ma
PEAK HEATER-CATHODE VOLTAGE:		
Heater negative with respect to cathode.....	180 <i>max</i>	volts
Heater positive with respect to cathode.....	180 <i>max</i>	volts

Characteristics:

Plate Voltage.....	100	250	volts
Grid Voltage.....	0	-8.5	volts
Amplification Factor.....	19.5	17	
Plate Resistance (Approx.).....	6250	7700	ohms
Transconductance.....	3100	2200	μmhos
Plate Current.....	11.8	10.5	ma

Maximum Circuit Values (For maximum rated conditions):

Grid-Circuit Resistance {	Cathode Bias.....	1.0 <i>max</i>	megohm
	Fixed Bias.....	0.25 <i>max</i>	megohm

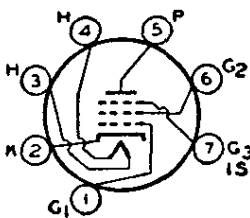
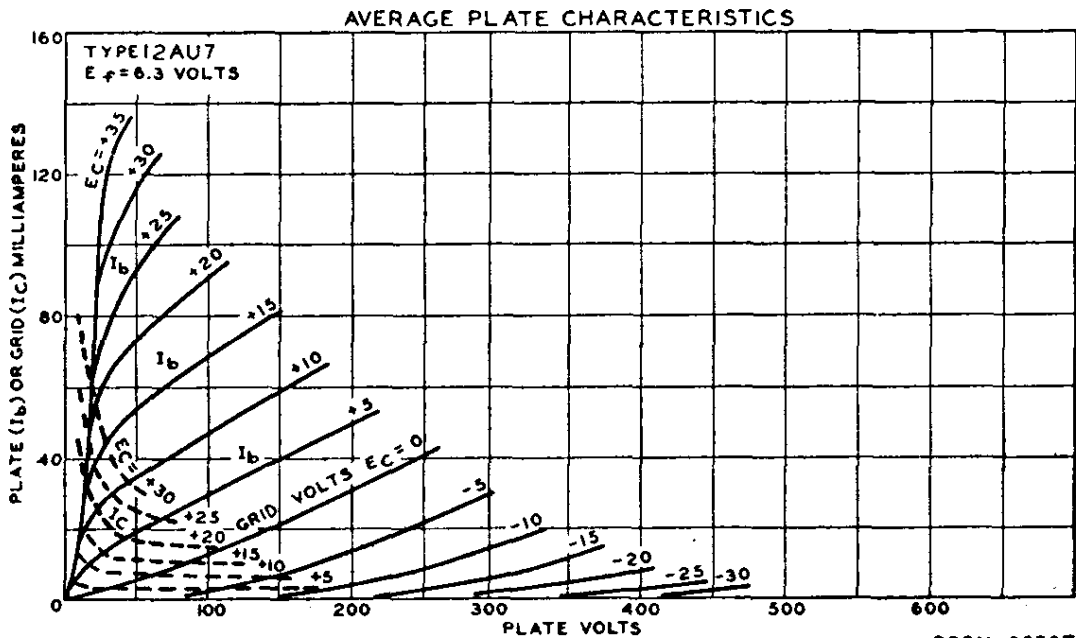

SHARP-CUTOFF PENTODE

Miniature type used as an rf or if amplifier up to 400 megacycles in compact ac/dc FM receivers. Outline 10, **OUTLINES SECTION**. Tube requires miniature seven-contact socket

12AW6

and may be mounted in any position. Heater volts (ac/dc), 12.6; amperes, 0.15. Except for heater ratings and terminal connections, this type is identical with miniature type 6AG5.

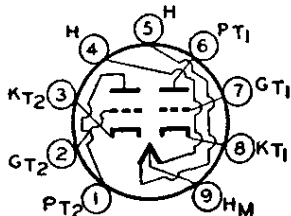

HIGH-MU TWIN TRIODE

Miniature type used as phase inverter or resistance-coupled amplifier in radio equipment and in many diversified applications such as multivibrators or oscillators in industrial control

12AX7

devices. Outline 11, **OUTLINES SECTION**. Tube requires noval nine-contact socket and may be mounted in any position. Its characteristics are similar to glass-octal type 6SL7-GT. Each triode unit is independent of the other except for the common heater. For typical operation as a resistance-coupled amplifier, refer to Chart 25, **RESISTANCE-COUPLED AMPLIFIER SECTION**.

RCA RECEIVING TUBE MANUAL

HEATER ARRANGEMENT	<i>Series</i>	<i>Parallel</i>	
HEATER VOLTAGE (AC/DC)	12.6	6.3	volts
HEATER CURRENT	0.15	0.3	ampere

DIRECT INTERELECTRODE CAPACITANCES (No external shield):

	<i>Triode Unit T₁</i>	<i>Triode Unit T₂</i>	
Grid to Plate.....	1.7	1.7	$\mu\mu\text{f}$
Input.....	1.6	1.6	$\mu\mu\text{f}$
Output.....	0.46	0.33	$\mu\mu\text{f}$

Maximum Ratings:

CLASS A₁ AMPLIFIER

PLATE VOLTAGE	300 <i>max</i>	volts
PLATE DISSIPATION	1 <i>max</i>	watt
GRID VOLTAGE:		
Negative bias value.....	50 <i>max</i>	volts
Positive bias value.....	0 <i>max</i>	volts
PEAK HEATER-CATHODE VOLTAGE:		
Heater negative with respect to cathode.....	180 <i>max</i>	volts
Heater positive with respect to cathode.....	180 <i>max</i>	volts

Characteristics:

Plate Voltage.....	250	volts
Grid Voltage.....	-2	volts
Amplification Factor.....	100	
Plate Resistance (Approx.).....	62500	ohms
Transconductance.....	1600	μmhos
Plate Current.....	1.2	ma

TRIODE—PENTODE

12B8-GT

Glass octal type used as combined detector and rf or if amplifier in ac/dc receivers. Heater volts (ac/dc), 12.6; amperes, 0.3. Characteristics of triode unit: plate volts, 90; grid volts, 0; amplification factor, 90; plate resistance, 37000 ohms; transconductance, 2400 μmhos ; plate ma., 2.8. Characteristics of pentode unit: plate volts, 90; grid-No.2 volts, 90; grid-No.1 volts,

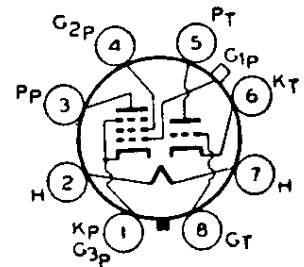

-3; plate resistance, 200000 ohms; transconductance, 1800 μmhos ; grid-No.1 volts for transconductance of 2 μmhos , -42.5; plate ma., 7; grid-No.2 ma., 2. This is a **DISCONTINUED** type listed for reference only.

REMOTE-CUTOFF PENTODE

12BA6

Miniature type used as rf amplifier in ac/dc standard broadcast receivers, in FM receivers, and in other wide-band, high-frequency applications. Outline 10, **OUTLINES SECTION**. Heater volts (ac/dc), 12.6; amperes, 0.15. Except for heater ratings, this type is identical with miniature type 6BA6.

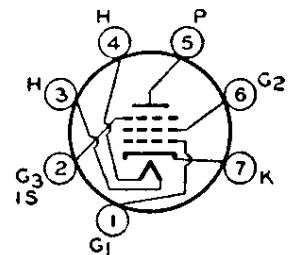

PENTAGRID CONVERTER

12BE6

Miniature type used as converter in ac/dc receivers for both standard broadcast and FM bands, **OUTLINES SECTION**. Heater volts (ac/dc), 12.6; amperes, 0.15. Except for heater rating, this type is identical with miniature type 6BE6.

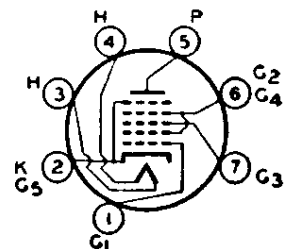

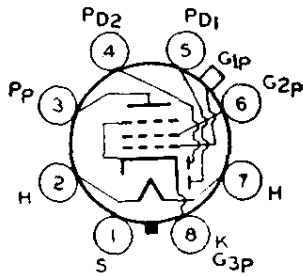

TWIN DIODE—REMOTE-CUTOFF PENTODE

12C8

Metal type used as combined detector, amplifier, and avc tube in ac/dc receivers. Outline 4, OUTLINES SECTION. Heater volts (ac/dc), 12.6; amperes, 0.15. Except for heater rating, this type is identical with metal type 6B8.

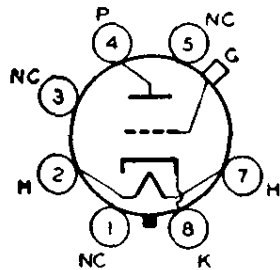

HIGH-MU TRIODE

12F5-GT

Glass octal type used in resistance-coupled amplifier circuits of ac/dc receivers. Outline 16, OUTLINES SECTION. Heater volts (ac/dc), 12.6; amperes, 0.15. Except for heater rating, this type is identical with glass-octal type 6F5-GT.

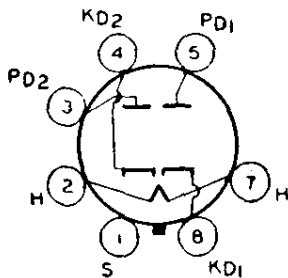

TWIN DIODE

12H6

Metal type used as detector, low-voltage rectifier, or avc tube in ac/dc radio receivers. Outline 1, OUTLINES SECTION. Heater volts (ac/dc), 12.6; amperes, 0.15. Except for heater rating, this type is identical with metal type 6H6.

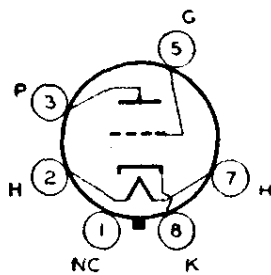

MEDIUM-MU TRIODE

12J5-GT

Glass octal type used as detector, amplifier, or oscillator in ac/dc radio equipment. Outline 19, OUTLINES SECTION. Heater volts (ac/dc), 12.6; amperes, 0.15. Except for heater rating, this type is identical with glass-octal type 6J5-GT.

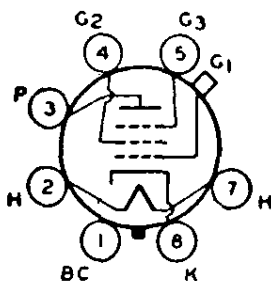

SHARP-CUTOFF PENTODE

12J7-GT

Glass octal type used as biased detector or high-gain audio amplifier in ac/dc radio receivers. Outline 18, OUTLINES SECTION. Heater volts (ac/dc), 12.6; amperes, 0.15. Except for heater rating, this type is identical with glass-octal type 6J7-GT.

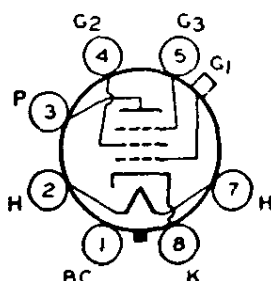

REMOTE-CUTOFF PENTODE

12K7-GT

Glass octal type used as rf or if amplifier in ac/dc radio receivers particularly those employing avc. Outline 18, OUTLINES SECTION. Heater volts (ac/dc), 12.6; amperes, 0.15. Except for heater rating, this type is identical with glass-octal type 6K7-GT.

TRIODE—HEXODE CONVERTER

12K8

Metal type used as combined triode oscillator and hexode mixer in ac/dc radio receivers. Outline 5, OUTLINES SECTION. Heater volts (ac/dc), 12.6; amperes, 0.15. Except for heater rating, this type is identical with metal type 6K8.

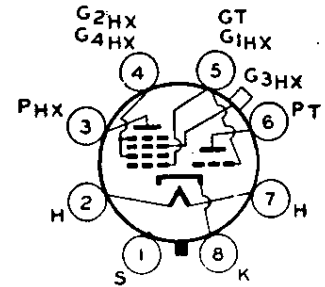

**TWIN DIODE—
HIGH-MU TRIODE**

12Q7-GT

Glass octal type used as combined detector, amplifier, and avc tube in ac/dc radio receivers. Outline 18, OUTLINES SECTION. Heater volts (ac/dc), 12.6; amperes, 0.15. Except for heater rating, this type is identical with glass-octal type 6Q7-GT.

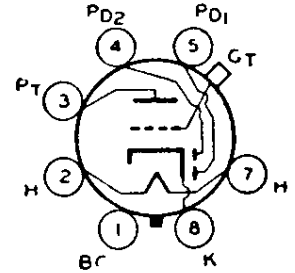

PENTAGRID CONVERTER

12SA7

Metal type 12SA7 and glass-octal type 12SA7-GT used as converter in ac/dc receivers. Outlines 3 and 17, respectively, OUTLINES SECTION. Heater volts (ac/dc), 12.6; amperes, 0.15. Except for heater ratings, type 12SA7 is identical with metal type 6SA7, and type 12SA7-GT is identical with glass-octal type 6SA7-GT.

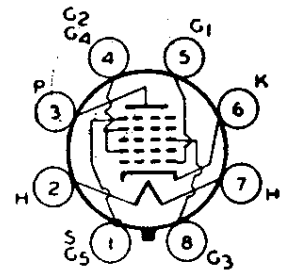

12SA7-GT

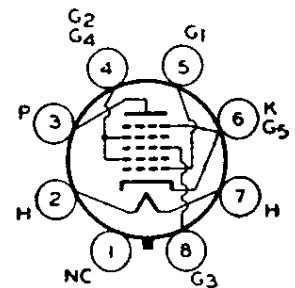

HIGH-MU TWIN TRIODE

12SC7

Metal type used as phase inverter or voltage amplifier in ac/dc radio equipment. Outline 3, OUTLINES SECTION. Heater volts (ac/dc), 12.6; amperes, 0.15. Except for heater rating, this type is identical with metal type 6SC7.

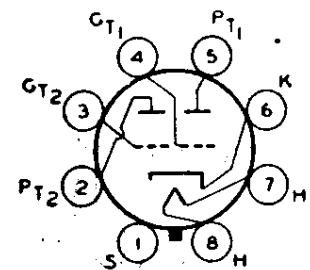

HIGH-MU TRIODE

**12SF5
12SF5-GT**

Metal type 12SF5 and glass-octal type 12SF5-GT used in resistance-coupled amplifier circuits of ac/dc radio equipment. Outlines 3 and 17, respectively, OUTLINES SECTION. Heater volts (ac/dc), 12.6; amperes, 0.15. Except for heater rating, type 12SF5 is identical with metal type 6SF5, and type 12SF5-GT is identical with glass-octal type 6SF5-GT. Type 12SF5-GT is a DISCONTINUED type listed for reference only.

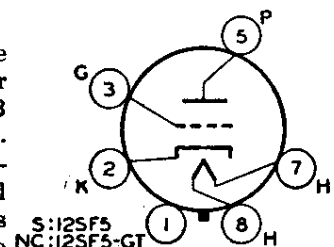

DIODE—

REMOTE-CUTOFF PENTODE

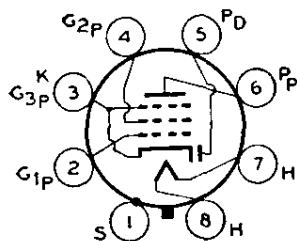

Metal type used as combined rf or if amplifier and detector or avc tube in ac/dc radio receivers. Outline 3, OUTLINES SECTION. Heater volts (ac/dc), 12.6; amperes, 0.15. Except for heater rating, this type is identical with metal type 6SF7.

12SF7

REMOTE-CUTOFF PENTODE

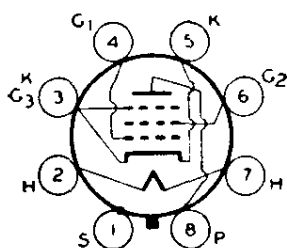

Metal type used as rf amplifier in ac/dc receivers involving high-frequency, wide-band applications. Outline 3, OUTLINES SECTION. Heater volts (ac/dc), 12.6; amperes, 0.15. Except for heater rating, this type is identical with metal type 6SG7.

12SG7

SHARP-CUTOFF PENTODE

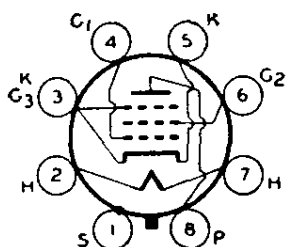

Metal type used as rf amplifier in ac/dc receivers involving high-frequency, wide-band applications and as limiter tube in FM equipment. Outline 3, OUTLINES SECTION. Heater volts (ac/dc), 12.6; amperes, 0.15. Except for heater rating, this type is identical with metal type 6SH7.

12SH7

SHARP-CUTOFF PENTODE

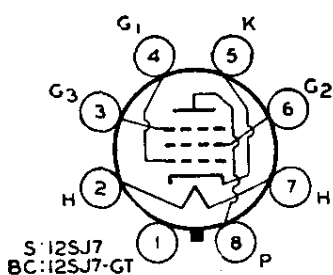

S: 12SJ7
BC: 12SJ7-GT

Metal type 12SJ7 and glass-octal type 12SJ7-GT used as rf amplifiers and biased detectors in ac/dc radio receivers. Outlines 3 and 19, respectively, OUTLINES SECTION.

12SJ7
12SJ7-GT

Heater volts (ac/dc), 12.6; amperes, 0.15. Except for heater rating, type 12SJ7 is identical with metal type 6SJ7, and type 12SJ7-GT is identical with glass-octal type 6SJ7-GT.

REMOTE-CUTOFF PENTODE

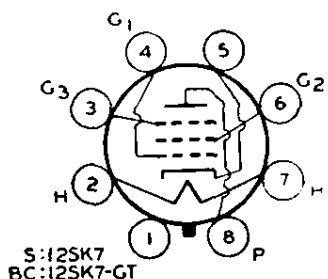

S: 12SK7
BC: 12SK7-GT

Metal type 12SK7 and glass-octal type 12SK7-GT used as rf and if amplifiers in ac/dc radio receivers. Outlines 3 and 19, respectively, OUTLINES SECTION. Heater volts

12SK7
12SK7-GT

(ac/dc), 12.6; amperes, 0.15. Except for heater rating, type 12SK7 is identical with metal type 6SK7, and type 12SK7-GT is identical with glass-octal type 6SK7-GT.

12SL7-GT

HIGH-MU TWIN TRIODE

Glass octal type used as phase inverter or resistance-coupled amplifier in ac/dc radio equipment. Outline 17, OUTLINES SECTION. Heater volts (ac/dc), 12.6; amperes, 0.15. Except for heater rating, this type is identical with glass-octal type 6SL7-GT.

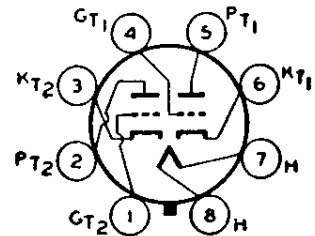

12SN7-GT

MEDIUM-MU TWIN TRIODE

Glass octal type used as phase inverter or resistance-coupled amplifier in ac/dc radio equipment. Outline 17, OUTLINES SECTION. Heater volts (ac/dc), 12.6; amperes, 0.3. Except for heater rating, this type is identical with glass-octal type 6SN7-GT.

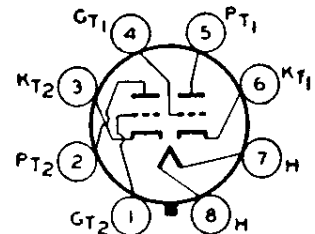

**12SQ7
12SQ7-GT**

**TWIN DIODE—
HIGH-MU TRIODE**

Metal type 12SQ7 and glass-octal type 12SQ7-GT used as combined detector, amplifier, and avc tube in ac/dc radio receivers. Outlines 3 and 19, respectively, OUTLINES SECTION.

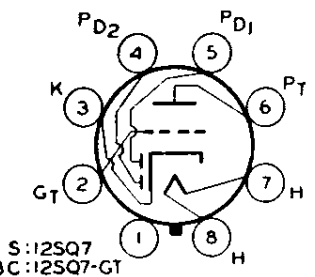

Heater volts (ac/dc), 12.6; amperes, 0.15. Except for heater rating, type 12SQ7 is identical with metal type 6SQ7, and type 12SQ7-GT is identical with glass-octal type 6SQ7-GT.

**12SR7
12SR7-GT**

TWIN DIODE—MEDIUM-MU TRIODE

Metal type 12SR7 and glass-octal type 12SR7-GT used as combined detector, amplifier, and avc tube in ac/dc radio receivers. Outlines 3 and 17, respectively, OUTLINES SECTION. Heater volts (ac/dc), 12.6; amperes, 0.15. Except for heater rating, type 12SR7 is identical with type 6SR7, and type 12SR7-GT is electrically identical with type 6SR7 except for interelectrode capacitances. Both types are similar in performance to miniature type 6BF6.

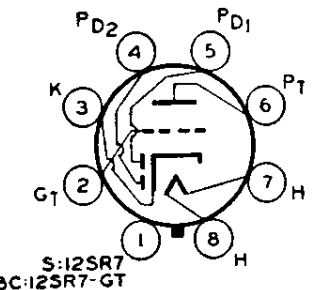

12Z3

HALF-WAVE VACUUM RECTIFIER

Glass type used in power supply of ac/dc receivers. Outline 25, OUTLINES SECTION. Tube requires four-contact socket and may be mounted in any position. It is especially important that this tube, like other power-handling tubes, should be adequately ventilated. Use of capacitor-input filter recommended in order to obtain as high a dc output voltage as possible.

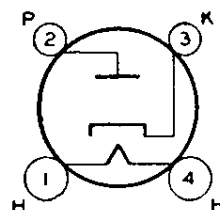

Heater volts (ac/dc), 12.6; amperes, 0.3. Maximum ratings as half-wave rectifier: peak inverse plate volts, 700 max; peak plate ma., 330 max; dc output ma., 55 max; peak heater-cathode volts, 350 max. With typical operating ac plate voltages of 117, 150, and 235 volts RMS, the minimum total effective plate-supply impedance required is 0, 30, and 75 ohms, respectively.

14A4

MEDIUM-MU TRIODE

Glass lock-in type used as detector, amplifier, or oscillator in ac/dc radio receivers. Outline 12, OUTLINES SECTION. Tube requires lock-in socket. Heater volts (ac/dc), 12.6; amperes, 0.15. Except for heater rating and capacitances, this type is electrically identical with lock-in type 7A4 and metal type 6J5. The application of this type is similar to that of glass-octal type 12J5-GT.

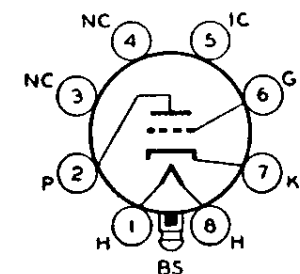

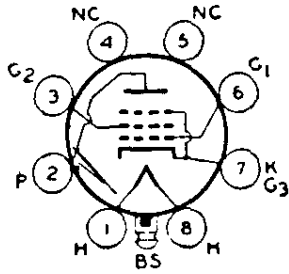

BEAM POWER AMPLIFIER

Glass lock-in type used as output amplifier in ac/dc radio receivers. Outline 12, OUTLINES SECTION. Tube requires lock-in socket. Heater volts (ac/dc), 12.6; amperes, 0.15. Typical operation and ratings as class A₁ amplifier: plate volts and grid-No.2 volts, 250 (300 max); plate dissipation, 7.5 watts; grid-No.2 dissipation, 1.5 watts; grid-No.1 volts, -12.5; plate ma., 32;

14A5

grid-No.2 ma., 5.5; plate resistance, 70000 ohms; transconductance, 3000 μmhos; load resistance, 7500 ohms; output watts, 2.8.

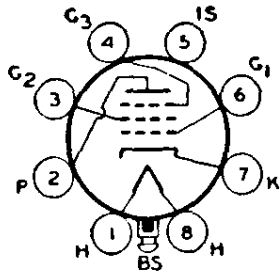

REMOTE-CUTOFF PENTODE

Glass lock-in type used as rf or if amplifier in ac/dc radio receivers. Outline 12, OUTLINES SECTION. Tube requires lock-in socket. Heater volts (ac/dc), 12.6; amperes, 0.15. Except for heater rating and capacitances, this type is electrically identical with metal type 6SK7 and lock-in type 7A7. The application of this type is similar to that of metal type 12SK7.

**14A7/
12B7**

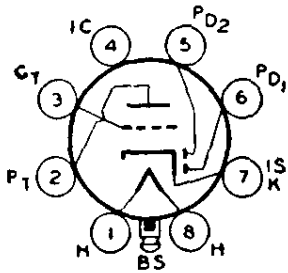

TWIN DIODE—HIGH-MU TRIODE

Glass lock-in type used as combined detector, amplifier, and avc tube in ac/dc radio receivers. Outline 12, OUTLINES SECTION. Tube requires lock-in socket. Heater volts (ac/dc), 12.6; amperes, 0.15. Except for heater rating and capacitances, this type is electrically identical with lock-in type 7B6 and metal type 6SQ7. The application of this type is similar to that of metal type 12SQ7.

14B6

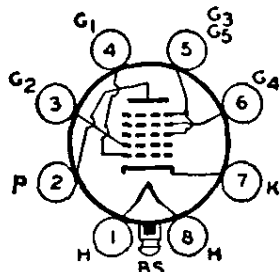

PENTAGRID CONVERTER

Glass lock-in type used as converter in ac/dc radio receivers. Outline 12, OUTLINES SECTION. Tube requires lock-in socket. Heater volts (ac/dc), 12.6; amperes, 0.15. Except for heater rating and capacitances, this type is electrically identical with lock-in type 7B8 and metal type 6A8. The application of this type is similar to that of glass-octal type 12A8-GT.

14B8

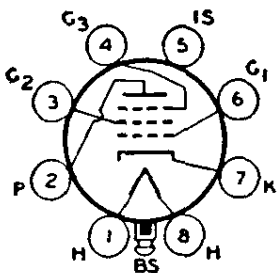

SHARP-CUTOFF PENTODE

Glass lock-in type used as rf amplifier and biased detector in ac/dc radio receivers. Outline 12, OUTLINES SECTION. Tube requires lock-in socket. Heater volts (ac/dc), 12.6; amperes, 0.15. Typical operation and maximum ratings as class A₁ amplifier: plate volts, 250 (300 max); grid-No.2 volts, 100 max; plate dissipation; 1 max watt; grid-No.2 dissipation, 0.1

14C7

max watt; grid No.1 volts, -3; grid No.3 connected to cathode at socket; plate resistance, greater than 1 megohm; transconductance, 1575 μmhos; plate ma., 2.2; grid-No.2 ma., 0.7. Within the limits of its maximum ratings, this type is similar in performance to metal types 6SJ7 and 12SJ7.

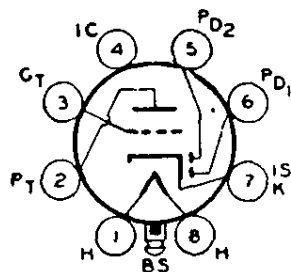

TWIN DIODE—MEDIUM-MU TRIODE

Glass lock-in type used as combined detector, amplifier, and avc tube in ac/dc radio receivers. Outline 12, OUTLINES SECTION. Tube requires lock-in socket. Heater volts (ac/dc), 12.6; amperes, 0.15. Except for heater rating, this type is electrically identical with lock-in type 7E6 and miniature type 6BF6. The application of this type is similar to that of metal type 12SR7.

14E6

HIGH-MU TWIN TRIODE

14F7

Glass lock-in type used as phase inverter or resistance-coupled amplifier in ac/dc radio receivers. Outline 12, OUTLINES SECTION. Tube requires lock-in socket. Heater volts (ac/dc), 12.6; amperes, 0.15. Except for heater rating, this type is electrically identical with lock-in type 7F7 and glass-octal type 6SL7-GT. The application of this type is similar to that of glass-octal type 12SL7-GT.

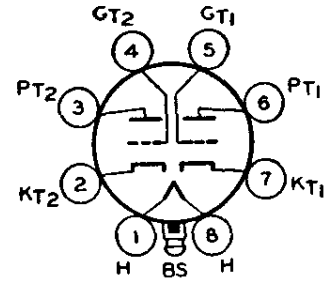

REMOTE-CUTOFF PENTODE

14H7

Glass lock-in type used as rf or if amplifier in ac/dc radio receivers. Outline 12, OUTLINES SECTION. Tube requires lock-in socket. Heater volts (ac/dc), 12.6; amperes, 0.15. Except for heater rating, this type is electrically identical with lock-in type 7H7. The application of this type is similar to that of miniature type 12BA6.

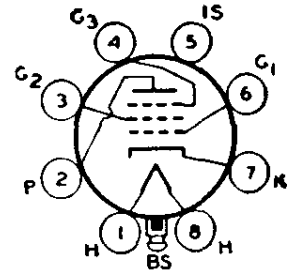

TRIODE—HEPTODE CONVERTER

14J7

Glass lock-in type used as combined triode oscillator and heptode mixer in ac/dc radio receivers. Outline 12, OUTLINES SECTION. Tube requires lock-in socket. Heater volts (ac/dc), 12.6; amperes, 0.15. Except for heater rating, this type is electrically identical with lock-in type 7J7.

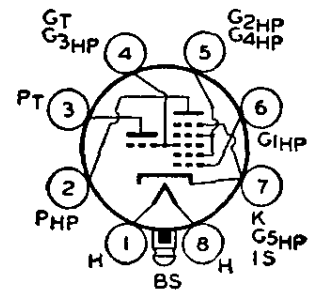

MEDIUM-MU TWIN TRIODE

14N7

Glass lock-in type used as voltage amplifier or phase inverter in ac/dc radio equipment. Outline 15, OUTLINES SECTION. Tube requires lock-in socket. Heater volts (ac/dc), 12.6; amperes, 0.3. Except for heater rating and capacitances, this type is electrically identical with lock-in type 7N7 and glass-octal type 6SN7-GT. The application of this type is similar to that of glass-octal type 12SN7-GT.

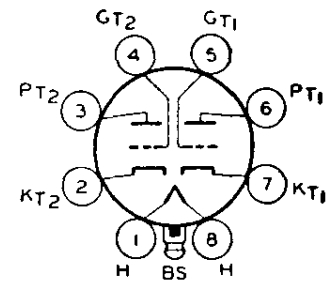

PENTAGRID CONVERTER

14Q7

Glass lock-in type used as converter in ac/dc radio receivers. Outline 12, OUTLINES SECTION. Tube requires lock-in socket. Heater volts (ac/dc), 12.6; amperes, 0.15. Except for heater ratings and capacitances, this type is electrically identical with metal type 6SA7 and lock-in type 7Q7. The application of this type is similar to that of metal type 12SA7.

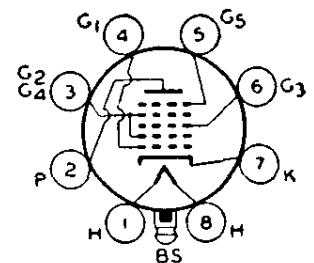

**TWIN DIODE—
REMOTE-CUTOFF PENTODE**

14R7

Glass lock-in type used as combined detector, amplifier, and avc tube in ac/dc radio receivers. Outline 12, OUTLINES SECTION. Tube requires lock-in socket. Heater volts (ac/dc), 12.6; amperes, 0.15. Except for heater rating, this type is electrically identical with lock-in type 7R7.

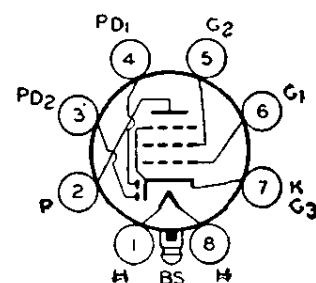

SHARP-CUTOFF PENTODE

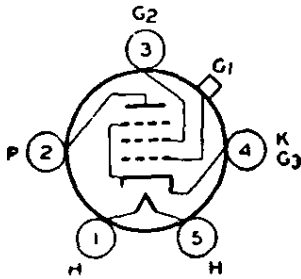

Glass type used as rf amplifier in battery-operated receivers. Outline 27, OUTLINES SECTION. Tube requires five-contact socket. Heater volts (dc), 2.0; amperes, 0.22. Typical operation as class A₁ amplifier: plate volts, 135 *max*; grid-No.2 (screen) volts, 67.5 *max*; grid-No.1 volts, -1.5; plate ma., 1.85; grid-No.2 ma., 0.3; plate resistance, 0.80 megohm; transconductance, 750 μ mhos. This type is used principally for renewal purposes.

15

HIGH-MU TWIN POWER TRIODE

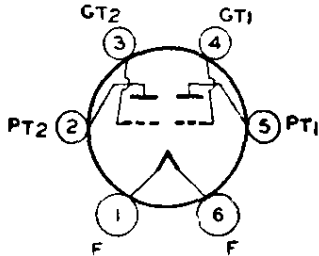

Glass type used in output stage of battery-operated receivers. Outline 25, OUTLINES SECTION. Tube requires six-contact socket. Filament volts (dc), 2.0; amperes, 0.26. Except for filament current, this type is electrically identical with type 1J6-G. Type 19 is used principally for renewal purposes.

19

POWER TRIODE

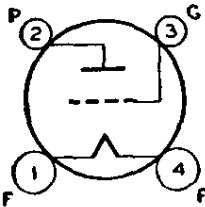

Glass type used as output amplifier in dry-battery-operated receivers. Filament volts (dc), 3.3; amperes, 0.132. Characteristics as class A₁ amplifier: plate volts, 135 *max*; grid volts, -22.5; plate ma., 6.5; plate resistance, 6300 ohms; amplification factor, 3.3; transconductance, 525 μ mhos; load resistance, 6500 ohms; output mw., 110. This is a DISCONTINUED type listed for reference only.

20

SHARP-CUTOFF TETRODE

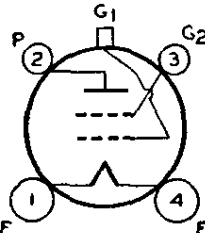

Glass type used as rf amplifier in dry-battery-operated receivers. Outline 32, OUTLINES SECTION. Filament volts (dc), 3.3; amperes, 0.132. Characteristics as class A₁ amplifier: plate volts, 135 *max*; grid-No.2 (screen) volts, 67.5 *max*; grid-No.1 volts, -1.5; plate ma., 3.7; grid-No.2 ma., 1.3; plate resistance, 325000 ohms; transconductance, 500 μ mhos. This is a DISCONTINUED type listed for reference only.

22

SHARP-CUTOFF TETRODE

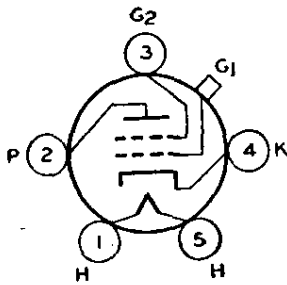

conductance, 1050 μ mhos; plate ma., 4; grid-No.2 ma., 1.7 *max*. This type is used principally for renewal purposes.

24-A

POWER PENTODE

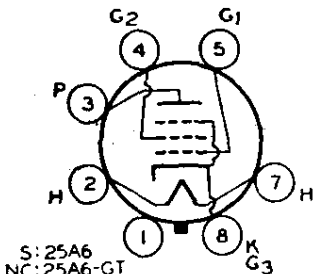

S: 25A6
NC: 25A6-GT

Metal type 25A6 and glass-octal type 25A6-GT are used in output stage of ac/dc receivers. Outlines 6 and 17, respectively, OUTLINES SECTION. Tubes require octal socket and may be mounted in any position. Heater

25A6
25A6-GT

volts (ac/dc), 25; amperes, 0.3. Maximum ratings as class A₁ amplifier: plate volts, 160; grid-No.2 volts, 135; plate dissipation, 5.3 watts; grid-No.2 dissipation, 1.9 watts. Type 25A6-GT is a DISCONTINUED type listed for reference only.

Typical Operation:

CLASS A₁ AMPLIFIER

Plate Voltage.....	95	135	160	volts
Grid-No.2 (Screen) Voltage.....	95	135	120	volts
Grid-No.1 (Control-Grid) Voltage.....	-15	-20	-18	volts
Zero-Signal Plate Current.....	20	37	33	ma
Zero-Signal Grid-No.2 Current.....	4	8	6.5	ma
Plate Resistance.....	45000	35000	42000	ohms
Transconductance.....	2000	2450	2375	μmhos
Load Resistance.....	4500	4000	5000	ohms
Maximum-Signal Power Output.....	0.9	2	2.2	watts

25A7-GT

RECTIFIER—POWER PENTODE

Glass octal type used as combined half-wave rectifier and power amplifier. Outline 17, OUTLINES SECTION. Heater volts (ac/dc), 25; amperes, 0.3. Typical operation of pentode unit as class A₁ amplifier: plate volts and grid-No.2 volts, 100 (117 max); grid-No.1 volts, -15; plate ma., 20.5; grid-No.2 ma., 4; plate resistance, 50000 ohms, transconductance, 1800

μmhos; load resistance, 4500 ohms; output watts, 0.77. Maximum ratings of rectifier unit: peak inverse plate volts, 350; peak plate ma., 450; dc output ma., 75; peak heater-cathode volts, 175. This is a DISCONTINUED type listed for reference only.

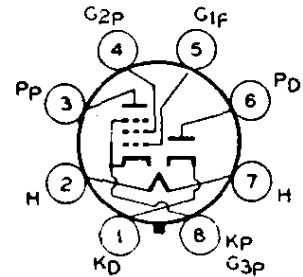

25AC5-GT

HIGH-MU POWER TRIODE

Glass octal type used in output stage of ac/dc receivers. Outline 17, OUTLINES SECTION. Heater volts (ac/dc), 25; amperes, 0.3. Maximum ratings: plate volts, 180 max; plate dissipation, 10 max watts. Type 25AC5-GT is used principally for renewal purposes.

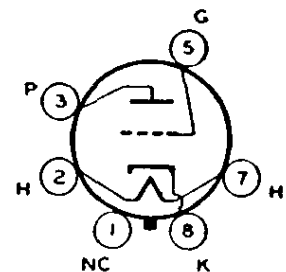

25B5

DIRECT-COUPLED POWER AMPLIFIER

Glass type used as class A₁ power amplifier. One triode, the driver, is directly connected within the tube to the second, or output, triode. Heater volts (ac/dc), 25; amperes, 0.3. Maximum ratings and characteristics are the same as for type 25N6-G. This is a DISCONTINUED type listed for reference only.

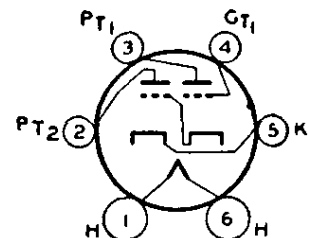

25B6-G

POWER PENTODE

Glass octal type used in output stage of ac/dc receivers. Outline 28, OUTLINES SECTION. Heater volts (ac/dc), 25; amperes, 0.3. Typical operation as class A₁ amplifier: plate volts, 200 max; grid-No.2 volts, 135 max; grid-No.1 volts, -23; plate ma., 62; grid-No.2 ma., 1.8; plate resistance, 18000 ohms; transconductance, 5000 μmhos; load resistance, 2500 ohms; output watts, 7.1. This is a DISCONTINUED type listed for reference only.

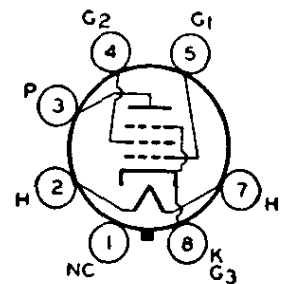

25B8-GT

TRIODE—PENTODE

Glass octal type used as amplifier. High-mu triode unit and remote-cutoff pentode unit are independent. Outline 17, OUTLINES SECTION. Heater volts (ac/dc), 25; amperes, 0.15. Typical operation of pentode unit as class A₁ amplifier: plate volts and grid-No.2 volts, 100; grid-No.1 volts, -3; plate ma., 7.6; grid-No.2 ma., 2; plate resistance, 185000 ohms; transcon-

ductance, 2000 μmhos, grid-No.1 volts for transconductance of 2 μmhos, -41. Triode unit: plate volts, 100; grid volts, -1; plate ma., 0.6; amplification factor, 112; plate resistance, 75000; transconductance, 1500 μmhos. This is a DISCONTINUED type listed for reference only.

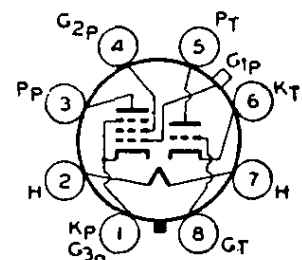

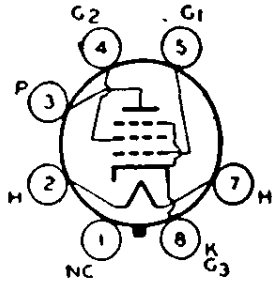

BEAM POWER AMPLIFIER

Glass octal type used as output amplifier Outline 28, OUTLINES SECTION. Heater volts (ac/dc), 25; amperes, 0.3. Refer to type 6Y6-G for typical operation as a class A₁ amplifier. This is a DISCONTINUED type listed for reference only.

25C6-G

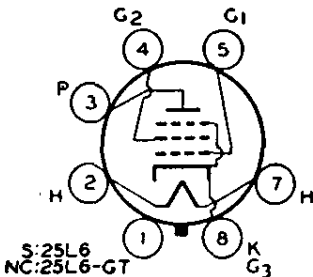

BEAM POWER AMPLIFIER

Metal type 25L6 and glass-octal type 25L6-GT are used in output stage of ac/dc receivers. Outlines 6 and 17, respectively, OUTLINES SECTION. These tubes require octal sockets and

**25L6
25L6-GT**

may be mounted in any position. Heater volts (ac/dc), 25; amperes, 0.3. For maximum ratings and typical operation, refer to type 50L6-GT. Refer to miniature type 50B5 for curves, installation, and application information, but take into consideration the differences in heater ratings.

**DIRECT-COUPLED TWIN
POWER AMPLIFIER**

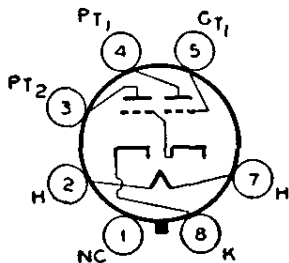

Glass octal type used as class A₁ power amplifier. One triode, the driver, is directly connected within the tube to the second, or output, triode. Heater volts (ac/dc), 25; amperes, 0.3. Characteristics as class A₁ amplifier—input triode: plate volts, 100 (180 max); grid volts, 0; peak af grid volts, 29.7; plate ma., 5.8. Output triode: plate volts, 180 max; plate ma., 46; load resistance, 4000 ohms; output watts, 3.8. This is a DISCONTINUED type listed for reference only.

25N6-G

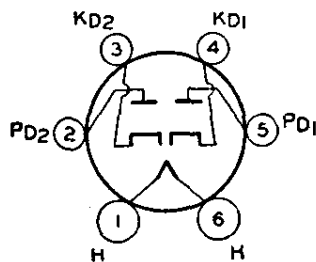

VACUUM RECTIFIER-DOUBLER

Glass type used as half-wave rectifier or voltage doubler in ac/dc receivers. Outline 25, OUTLINES SECTION. Heater volts (ac/dc), 25; amperes, 0.3. Maximum ratings: peak inverse plate volts, 700; peak plate ma. per plate, 450; peak heater-cathode volts, 350; dc output ma. per plate, 75. This is a DISCONTINUED type listed for reference only.

25Y5

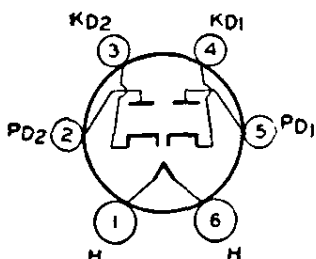

VACUUM RECTIFIER-DOUBLER

Glass type used as half-wave rectifier or voltage doubler in ac/dc receivers. For voltage-doubler considerations, refer to ELECTRON TUBE APPLICATIONS SECTION. Outline

25Z5

25, OUTLINES SECTION. Tube requires six-contact socket and may be mounted in any position. Heater volts (ac/dc), 25; amperes, 0.3. This type is electrically identical with metal type 25Z6.

25Z6 25Z6-GT

VACUUM RECTIFIER-DOUBLER

Metal type 25Z6 and glass-octal type 25Z6-GT used as half-wave rectifiers or voltage-doublers in ac/dc receivers. These types are used particularly in "transformerless" receivers of either the ac/dc type or the voltage-

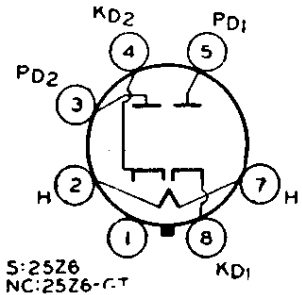

doubler type. Outlines 6 and 17, respectively, OUTLINES SECTION. Tubes require octal socket and may be mounted in any position.

HEATER VOLTAGE (AC/DC)	25	volts
HEATER CURRENT	0.3	ampere

Maximum Ratings:

HALF-WAVE RECTIFIER

PEAK INVERSE PLATE VOLTAGE	700 max	volts
PEAK PLATE CURRENT PER PLATE	450 max	ma
DC OUTPUT CURRENT PER PLATE	75 max	ma
PEAK HEATER-CATHODE VOLTAGE	350 max	volts

Typical Operation (Capacitor-Input Filter):^o

(Unless otherwise indicated, values are for both plates in parallel.)

AC Plate-Supply Voltage per Plate (RMS)	117	150	235	volts
Filter-Input Capacitor	16	16	16	μ f
Min. Total Effective Plate-Supply Impedance per Plate†	15	40	100	ohms
DC Output Current per Plate	75	75	75	ma
DC Output Voltage At Input to Filter (Approx.):				
At half-load current (75 ma.)	115	-	255	volts
At full-load current (150 ma.)	80	-	200	volts
Voltage Regulation (Approx.):				
Half-load to full-load current	35	-	55	volts

Maximum Ratings:

VOLTAGE DOUBLER

(Same as for Half-Wave Rectifier.)

Typical Operation:

	Half-Wave	Full-Wave	
AC Plate-Supply Voltage per Plate (RMS)	117	117	volts
Filter-Input Capacitor (Each)	16	16	μ f
Min. Total Effective Plate-Supply Impedance per Plate†	30	15	ohms
DC Output Current	75	75	ma*

^o In half-wave rectifier service, the two units may be used separately or in parallel.

† When a filter-input capacitor larger than 40 μ f is used, it may be necessary to use more plate-supply impedance than the minimum value shown to limit the peak plate current to the rated value.

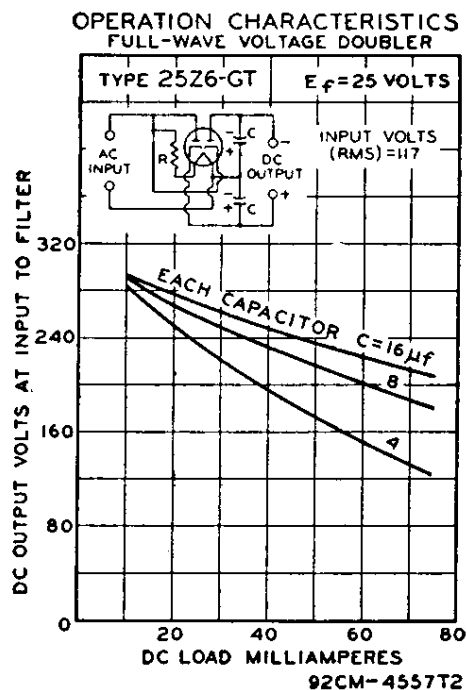
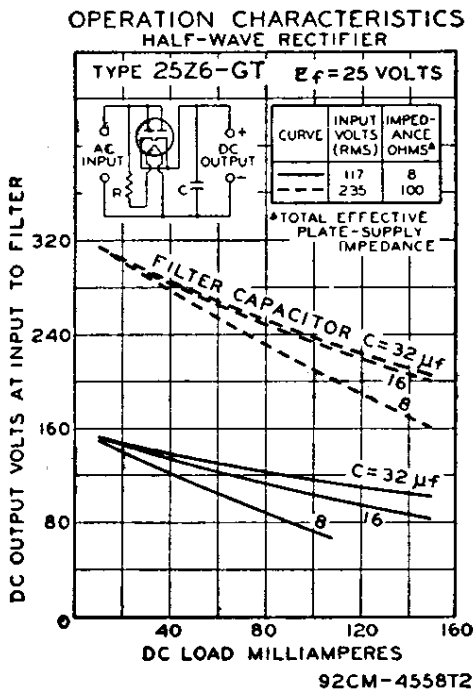

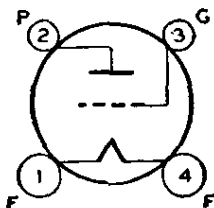

MEDIUM-MU TRIODE

Glass type used as rf voltage amplifier in ac-operated receivers. Outline 29, OUTLINES SECTION. Tube requires four-contact socket. Filament volts (ac/dc), 1.5; amperes, 1.05. This type is used principally for renewal purposes.

26

Characteristics:

CLASS A₁ AMPLIFIER

Plate Voltage (180 volts max).....	90	135	180	volts
Grid Voltage.....	-7	-10	-14.5	volts
Amplification Factor.....	8.3	8.3	8.3	
Plate Resistance.....	8900	7600	7300	ohms
Transconductance.....	935	1100	1150	μmhos
Plate Current.....	2.9	5.5	6.2	ma

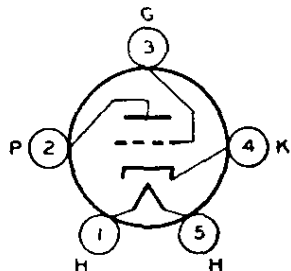

MEDIUM-MU TRIODE

Glass type used as voltage amplifier or detector in ac-operated receivers. Outline 25, OUTLINES SECTION. Tube requires five-contact socket. Heater volts (ac/dc), 2.5; amperes, 1.75. This type is used principally for renewal purposes.

27

Characteristics:

CLASS A₁ AMPLIFIER

Plate Voltage (275 volts max).....	90	135	180	250	volts
Grid Voltage.....	-6	-9	-13.5	-21	volts
Amplification Factor.....	9	9	9	9	
Plate Resistance.....	11000	9000	9000	9250	ohms
Transconductance.....	820	1000	1000	975	μmhos
Plate Current.....	2.7	4.5	5.0	5.2	ma

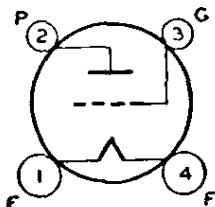

MEDIUM-MU TRIODE

Glass type used as voltage amplifier or detector in battery-operated receivers. Outline 25, OUTLINES SECTION, Tube requires four-contact socket. Filament volts (dc), 2.0; amperes, 0.06. Except for interelectrode capacitances, this type is electrically identical with glass-octal type 1H4-G. Type 30 is used principally for renewal purposes.

30

POWER TRIODE

Glass type used in output stage of battery-operated receivers. Outline 25, OUTLINES SECTION. Tube requires four-contact socket. Filament volts (dc), 2.0; amperes, 0.13. Typical operation as class A₁ amplifier: plate volts, 180 max; grid volts, -30; plate ma., 12.3; plate resistance, 3600 ohms; amplification factor, 3.8; transconductance, 1050 μmhos; load resistance, 5700 ohms; output watts, 0.375. This type is used principally for renewal purposes.

31

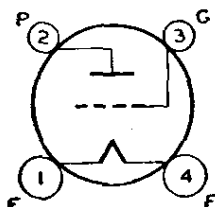

SHARP-CUTOFF TETRODE

Glass type used as rf amplifier or biased detector in battery-operated receivers. Outline 32, OUTLINES SECTION. Tube requires four-contact socket. Filament volts (dc), 2.0; amperes, 0.06. Typical operation as class A₁ amplifier: plate volts, 180 max; grid-No.2 ma., 0.4 max; plate resistance, greater than 1 megohm; plate ma., 1.7; transconductance, 650 μmhos. This type is used principally for renewal purposes.

32

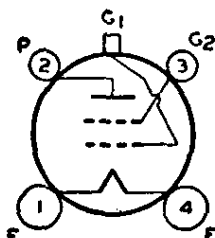

RECTIFIER—BEAM POWER AMPLIFIER

32L7-GT

Glass octal type used as combined half-wave rectifier and output amplifier in ac/dc receivers. Outline 17, OUTLINES SECTION. Tube requires octal socket. Heater volts (ac/dc), 32.5; amperes, 0.3. Maximum ratings for rectifier unit: ac plate volts (RMS), 125; dc output ma., 60. Typical operation of beam power unit as class A₁ amplifier: plate and grid-No.2 volts, 90; grid-No.1 volts, -7; plate ma., 27; grid-No.2 ma., 2; plate resistance, 17000 ohms; transconductance, 4800 μmhos; load resistance, 2600 ohms; maximum-signal output watts, 1.0. This type is used principally for renewal purposes.

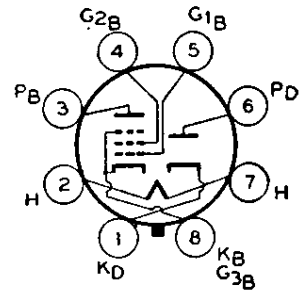

POWER PENTODE

33

Glass type used in output stage of battery-operated receivers. Outline 29, OUTLINES SECTION. Tube requires five-contact socket. Filament volts (dc), 2.0; amperes, 0.26. Typical operation as class A₁ amplifier: plate and grid-No.2 volts, 180 max; grid-No.1 volts, -18; plate ma., 22; grid-No.2 ma., 5; plate resistance, 55000 ohms; transconductance, 1750 μmhos; load resistance, 6000 ohms; output watts, 1.4. This type is used principally for renewal purposes.

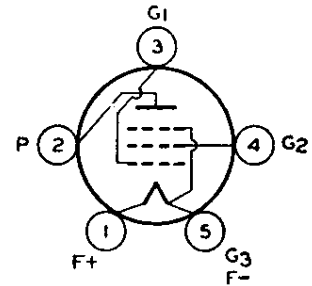

REMOTE-CUTOFF PENTODE

34

Glass type used as rf or if amplifier in battery-operated radio receivers, particularly those employing avc. Outline 32, OUTLINES SECTION. Tube requires four-contact socket. Filament volts (dc), 2.0; amperes, 0.06. Characteristics as class A₁ amplifier: plate volts, 180 max; grid-No.2 volts, 67.5 max; grid-No.1 volts, -3 min; plate ma., 2.8; grid-No.2 ma., 1.0; plate resistance, 1.0 megohm; transconductance, 620 μmhos; transconductance at grid-No.1 bias of -22.5 volts, 15 μmhos. This type is used principally for renewal purposes.

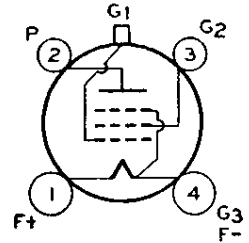

REMOTE-CUTOFF TETRODE

35

Glass type used as rf or if amplifier in ac receivers. Outline 32, OUTLINES SECTION. Tube requires five-contact socket. Heater volts (ac/dc), 2.5; amperes, 1.75. Characteristics as class A₁ amplifier: plate volts, 250 (275 max); grid-No.2 volts, 90 max; grid-No.1 volts, -3 min; plate ma., 6.5; grid-No.2 ma., 2.5; transconductance, 1050 μmhos; transconductance at grid-No.1 bias of -40 volts, 15 μmhos. This type is used principally for renewal purposes.

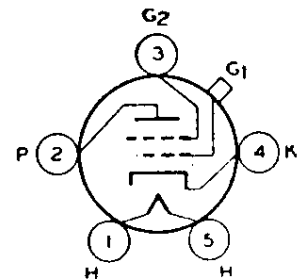

BEAM POWER AMPLIFIER

35A5

Glass lock-in type used in output stage of ac/dc receivers. Outline 15, OUTLINES SECTION. Tube requires lock-in socket. Heater volts (ac/dc), 35; amperes, 0.15. For ratings, and curves, refer to glass-octal type 35L6-GT.

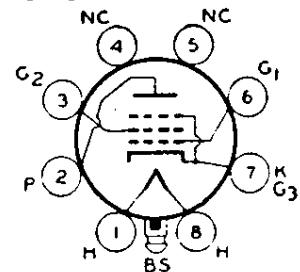

BEAM POWER AMPLIFIER

35B5

Miniature type used in output stage of compact, ac/dc radio receivers. Because of its high power sensitivity at plate and screen voltages available in ac/dc receivers, it is capable of providing a relatively high power output. Within its maximum ratings, type 35B5 is equivalent in performance to glass-octal type 35L6-GT.

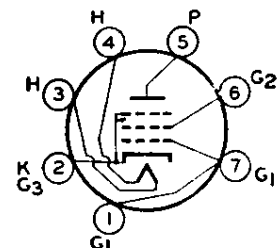

RCA RECEIVING TUBE MANUAL

HEATER VOLTS (AC/DC).....	35	volts
HEATER CURRENT.....	0.15	ampere
DIRECT INTERELECTRODE CAPACITANCES (Approx.):*		
Grid No.1 to Plate.....	0.4	$\mu\mu\text{f}$
Input.....	11	$\mu\mu\text{f}$
Output.....	6.5	$\mu\mu\text{f}$

* With no external shield.

Maximum Ratings:

CLASS A₁ AMPLIFIER

PLATE VOLTAGE.....	117 <i>max</i>	volts
GRID-NO.2 (SCREEN) VOLTAGE.....	117 <i>max</i>	volts
PLATE DISSIPATION.....	4.5 <i>max</i>	watts
GRID-NO.2 DISSIPATION.....	1.0 <i>max</i>	watt
PEAK HEATER-CATHODE VOLTAGE:		
Heater negative with respect to cathode.....	150 <i>max</i>	volts
Heater positive with respect to cathode.....	150 <i>max</i>	volts

Typical Operation:

Plate Voltage.....	110	volts
Grid-No.2 Voltage.....	110	volts
Grid-No.1 (Control-Grid) Voltage.....	-7.5	volts
Peak AF Grid-No.1 Voltage.....	7.5	volts
Zero-Signal Plate Current.....	40	ma
Maximum-Signal Plate Current.....	41	ma
Zero-Signal Grid-No.2 Current (Approx.).....	3	ma
Maximum-Signal Grid-No.2 Current (Approx.).....	7	ma
Transconductance.....	5800	μmhos
Load Resistance.....	2500	ohms
Total Harmonic Distortion.....	10	per cent
Maximum-Signal Power Output.....	1.5	watts

INSTALLATION AND APPLICATION

Type 35B5 requires miniature seven-contact socket and may be mounted in any position. Outline 13, OUTLINES SECTION.

The 35-volt heater is designed to operate under the normal conditions of line-voltage variation without materially affecting the performance or serviceability of the 35B5. For operation of the 35B5 in series with other types having 0.15-ampere rating, the current in the heater circuit should be adjusted to 0.15 ampere for the normal supply voltage.

In a series-heater circuit of the "dc power line" type employing several 0.15-ampere types and one or two 35B5's, the heater(s) of the 35B5('s) should be placed on the positive side of the line. Under these conditions, heater-cathode voltage of the 35B5 must not exceed the value given under maximum ratings. In a series-heater circuit of the "universal" type employing rectifier tube 35W4, one or two 35B5's and several 0.15-ampere types, it is recommended that the heater(s) of the 35B5('s), be placed in the circuit so that the higher values of heater-cathode bias will be impressed on the 35B5('s) rather than on the other 0.15-ampere types. This is accomplished by arranging the 35B5('s) on the side of the supply line which is connected to the cathode of the rectifier, i.e., the positive terminal of the rectified voltage supply. Between this side of the line and the 35B5('s), any necessary auxiliary resistance and the heater of the 35W4 are connected in series.

As a power amplifier (class A₁), the 35B5 is recommended for use either singly or in push-pull combination in the power-output stage of "ac/dc" receivers. The operating values shown under typical operation have been determined on the basis that grid current does not flow during any part of the input cycle. The type of input coupling used should not introduce too much resistance in the grid circuit. Transformer- or impedance-coupling devices are recommended.

When the tube is operated at maximum rated conditions, the grid circuit should have a dc resistance not higher than 0.1 megohm for fixed bias; for higher

values, cathode bias is required. With cathode bias, the grid circuit may have a dc resistance as high as, but not higher than, 0.5 megohm.

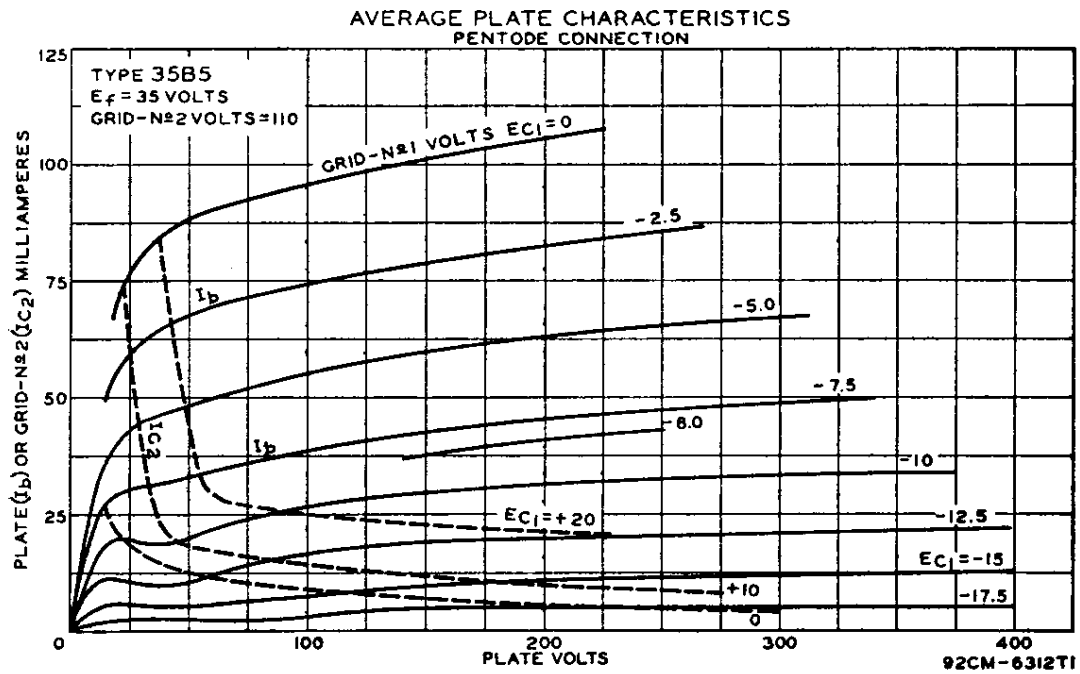

35L6-GT

BEAM POWER AMPLIFIER

Glass octal type used in output stage of ac/dc radio receivers. Outline 17, OUTLINES SECTION. Tube requires octal socket and may be mounted in any position. Refer to miniature type 35B5 for installation, application information, and curves.

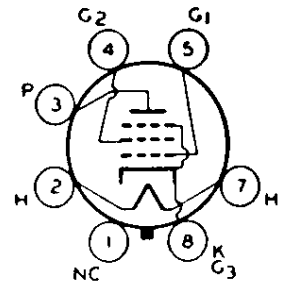

HEATER VOLTAGE (AC/DC)	35	volts
HEATER CURRENT	0.15	ampere
DIRECT INTERELECTRODE CAPACITANCES (Approx.):°		
Grid No.1 to Plate	0.8	μμf
Input	13	μμf
Output	9.5	μμf

° With no external shield.

Maximum Ratings:

CLASS A₁ AMPLIFIER

PLATE VOLTAGE	200 max	volts
GRID-NO.2 (SCREEN) VOLTAGE	117 max	volts
PLATE DISSIPATION	8.5 max	watts
GRID-NO.2 DISSIPATION	1.0 max	watt
PEAK HEATER-CATHODE VOLTAGE:		
Heater negative with respect to cathode	90 max	volts
Heater positive with respect to cathode	90 max	volts

Typical Operation:

Plate Voltage	110	200	volts
Grid-No.2 Voltage	110	110	volts
Grid-No.1 (Control-Grid) Voltage	-7.5	-8	volts
Peak AF Grid-No.1 Voltage	7.5	8	volts
Zero-Signal Plate Current	40	41	ma
Maximum-Signal Plate Current	41	44	ma
Zero-Signal Grid-No.2 Current (Approx.)	3	2	ma
Maximum-Signal Grid-No.2 Current (Approx.)	7	7	ma
Plate Resistance	14000	40000	ohms
Transconductance	5800	5900	μmhos
Load Resistance	2500	4500	ohms
Total Harmonic Distortion	10	10	per cent
Maximum-Signal Power Output	1.5	3.3	watts

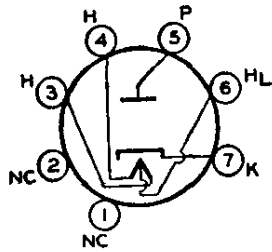

HALF-WAVE VACUUM RECTIFIER

Miniature type used in power supply of ac/dc receivers. Equivalent in performance to glass-octal type 35Z5-GT. The heater is provided with a tap for operation of a panel lamp.

35W4

HEATER VOLTAGE (AC/DC):	*	**	
ENTIRE HEATER (PINS 3 AND 4).....	35	32	volts
PANEL LAMP SECTION (PINS 4 AND 6).....	7.5	5.5	volts
HEATER CURRENT:			
BETWEEN PINS 3 AND 4.....	0.15	-	ampere
BETWEEN PINS 3 AND 6.....	-	0.15	ampere

* Without panel lamp. ** With No.40 or No.47 panel lamp.

Maximum Ratings:	HALF-WAVE RECTIFIER	
PEAK INVERSE PLATE VOLTAGE.....		330 <i>max</i> volts
PEAK PLATE CURRENT.....		600 <i>max</i> ma
DC OUTPUT CURRENT:		
With Panel Lamp and { No Shunting Resistor.....		60 <i>max</i> ma
{ Shunting Resistor.....		90 <i>max</i> ma
Without Panel Lamp.....		100 <i>max</i> ma
PANEL-LAMP-SECTION VOLTAGE (RMS):		
When Panel Lamp Fails.....		15 <i>max</i> volts
PEAK HEATER-CATHODE VOLTAGE:		
Heater negative with respect to cathode.....		330 <i>max</i> volts
Heater positive with respect to cathode.....		330 <i>max</i> volts

Typical Operation with Panel Lamp:†					
AC Plate-Supply Voltage (RMS).....	117	117	117	117	volts
Filter-Input Capacitor.....	40	40	40	40	μf
Minimum Total Effective Plate-Supply Impedance.....	15	15	15	15	ohms
Panel-Lamp Shunting Resistor.....	-	300	150	100	ohms
DC Output Current.....	60	70	80	90	ma

† No.40 or No.47 panel lamp used in circuit given below with capacitor-input filter.

Typical Operation without Panel Lamp:		
AC Plate-Supply Voltage (RMS).....	117	volts
Filter-Input Capacitor.....	40	μf
Minimum Total Effective Plate-Supply Impedance.....	15	ohms
DC Output Current.....	100	ma
DC Output Voltage at Input to Filter (Approx.):		
At half-load current (50 ma.).....	140	volts
At full-load current (100 ma.).....	120	volts
Voltage Regulation (Approx.):		
Half-load to full-load current.....	20	volts

INSTALLATION AND APPLICATION

Tube requires miniature seven-contact socket and may be mounted in any position. Outline 13, OUTLINES SECTION. For heater considerations, refer to miniature type 35B5.

With the panel lamp connected as shown in the diagram, the drop across R and all heaters (with panel lamp) should equal 117 volts at 0.15 ampere. The shunting resistor R_s is required when dc output current exceeds 60 milliamperes. For dc output of 70 milliamperes, an 800-ohm resistor (*max*) is required; for 80 milliamperes, 400 ohms (*max*); for 90 milliamperes, 250 ohms (*max*).

OPERATION CHARACTERISTICS HALF-WAVE RECTIFIER

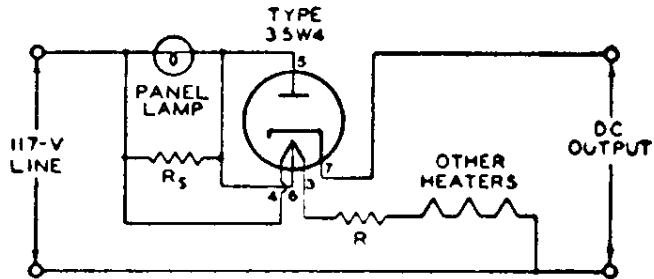
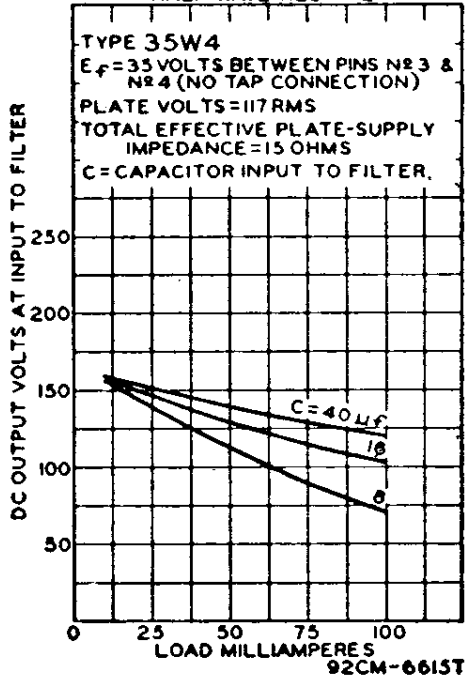

DROP ACROSS R AND ALL HEATERS (WITH PANEL LAMP) SHOULD EQUAL 117 VOLTS AT 0.15 AMPERE. R_s = SHUNTING RESISTOR REQUIRED WHEN DC OUTPUT CURRENT EXCEEDS 60 MILLIAMPERES

HALF-WAVE VACUUM RECTIFIER

35Y4

Glass lock-in type used in power supply of ac/dc receivers. The heater is provided with tap for the operation of a panel lamp. Outline 15, OUTLINES SECTION. Tube requires lock-in socket. Heater volts (ac/dc), 35; amperes, 0.15. For maximum ratings, refer to glass-octal type 35Z5-GT. For typical operation and curves, refer to miniature type 35W4.

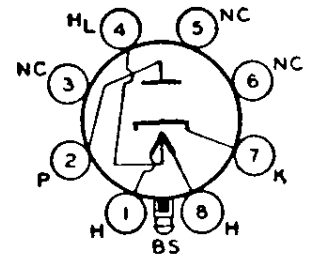

HALF-WAVE VACUUM RECTIFIER

35Z3

Glass lock-in type used in power supply of ac/dc receivers. Outline 15, OUTLINES SECTION. Tube requires lock-in socket. Heater volts (ac/dc), 35; amperes, 0.15. For maximum ratings and typical operation, refer to glass-octal type 35Z5-GT without panel lamp.

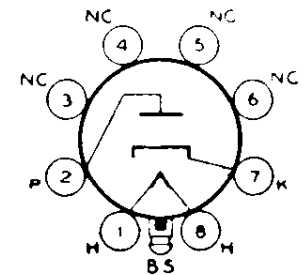

HALF-WAVE VACUUM RECTIFIER

35Z4-GT

Glass octal type used in power supply of ac/dc receivers. Outline 17, OUTLINES SECTION. Tube requires octal socket. Heater volts (ac/dc), 35; amperes, 0.15. For maximum ratings and typical operation, refer to glass-octal type 35Z5-GT without panel lamp.

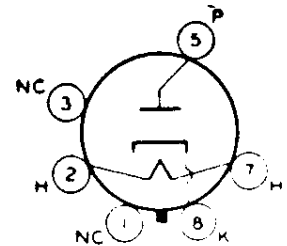

HALF-WAVE VACUUM RECTIFIER

35Z5-GT

Glass octal type used in power supply of ac/dc receivers. The heater is provided with a tap for operation of a panel lamp. Outline 17, OUTLINES SECTION. Tube requires

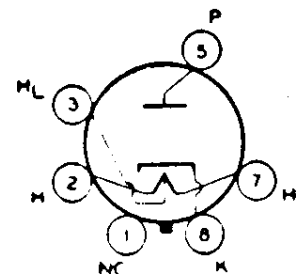

octal socket and may be mounted in any position. For installation and application considerations, refer to miniature type 35W4.

HEATER VOLTAGE (AC/DC):		*	**	
ENTIRE HEATER (PINS 2 AND 7).....	35	32		volts
PANEL LAMP SECTION (PINS 2 AND 3).....	7.5	5.5		volts
HEATER CURRENT:				
BETWEEN PINS 2 AND 7.....	0.15	-		ampere
BETWEEN PINS 3 AND 7.....	-	0.15		ampere
* Without panel lamp.		** With No.40 or No. 47 panel lamp.		

Maximum Ratings:

HALF-WAVE RECTIFIER

PEAK INVERSE PLATE VOLTAGE.....		700 <i>max</i>	volts
PEAK PLATE CURRENT.....		600 <i>max</i>	ma
DC OUTPUT CURRENT:			
With Panel Lamp and { No Shunting Resistor.....		60 <i>max</i>	ma
{ Shunting Resistor.....		90 <i>max</i>	ma
Without Panel Lamp.....		100 <i>max</i>	ma
PANEL-LAMP-SECTION VOLTAGE (RMS):			
When Panel Lamp Fails.....		15 <i>max</i>	volts
PEAK HEATER-CATHODE VOLTAGE:			
Heater negative with respect to cathode.....		330 <i>max</i>	volts
Heater positive with respect to cathode.....		330 <i>max</i>	volts

Typical Operation with Panel Lamp:†

AC Plate-Supply Voltage (RMS).....	117	117	117	117	235	volts
Filter-Input Capacitor.....	40	40	40	40	40	μf
Minimum Total Effective Plate-Supply Impedance.....	15	15	15	15	100	ohms
Panel-Lamp Shunting Resistor.....	-	300	150	100	-	ohms
DC Output Current.....	60	70	80	90	60	ma

† No.40 or No.47 panel lamp used in circuit with capacitor-input filter given under type 35W4.

Typical Operation without Panel Lamp:

AC Plate-Supply Voltage (RMS).....	117	235	volts
Filter-Input Capacitor.....	40	40	μf
Minimum Total Effective Plate-Supply Impedance.....	15	100	ohms
DC Output Current.....	100	100	ma
DC Output Voltage at Input to Filter (Approx.):			
At half-load current (50 ma.).....	140	280	volts
At full-load current (100 ma.).....	120	235	volts
Voltage Regulation (Approx.):			
Half-load to full-load current.....	20	45	volts

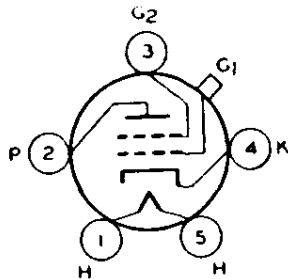

SHARP-CUTOFF TETRODE

Glass type used as rf or if amplifier or as biased or grid-resistor detector in radio receivers. Outline 27, OUTLINES SECTION. Tube requires five-contact socket. Heater volts (ac/dc), 6.3; amperes, 0.3. Characteristics as class A₁ amplifier: plate volts, 250 *max*; grid-No.2 volts, 90 *max*; grid-No.1 volts, -3; plate ma., 3.2; grid-No.2 ma., 1.7 *max*; plate resistance, 0.55 megohm; transconductance, 1080 μmhos. This type is used principally for renewal purposes.

36

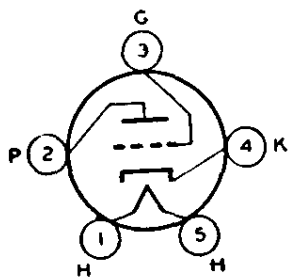

MEDIUM-MU TRIODE

Glass type used as voltage amplifier or detector in radio receivers. Outline 25, OUTLINES SECTION. Tube requires five-contact socket. Heater volts (ac/dc), 6.3; amperes, 0.3. Characteristics as class A₁ amplifier: plate volts, 250 *max*; grid volts, -18; plate ma., 7.5; plate resistance, 8400 ohms; amplification factor, 9.2; transconductance, 1100 μmhos. This type is used principally for renewal purposes.

37

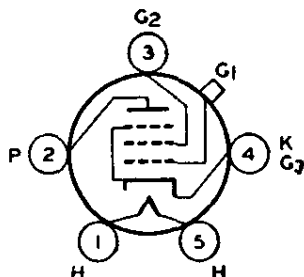

POWER PENTODE

Glass type used in output stage of radio receivers. Outline 27, OUTLINES SECTION. Tube requires five-contact socket. Heater volts (ac/dc), 6.3; amperes, 0.3. Characteristics as class A₁ amplifier: plate and grid-No.2 volts, 250 *max*; grid-No.1 volts, -25; plate ma., 22; grid-No.2 ma., 3.8; plate resistance, 0.1 megohm; transconductance, 1200 μmhos; load resistance, 10000 ohms; output watts, 2.5. This type is used principally for renewal purposes.

38

39/44

REMOTE-CUTOFF PENTODE

Glass type used as rf or if amplifier in radio receivers, particularly those employing avc. Outline 27, **OUTLINES SECTION**. Tube requires five-contact socket. Heater volts (ac/dc), 6.3; amperes, 0.3. Characteristics as class A₁ amplifier: plate volts, 250 *max*; grid-No.2 volts, 90 *max*; grid-No.1 volts, -3 *min*; plate ma., 5.8; grid-No.2 ma., 1.4; plate resistance, 1.0 megohm; transconductance, 1050 μ mhos; transconductance at grid-No.1 bias of -42.5 volts, 2 μ mhos. This type is used principally for renewal purposes.

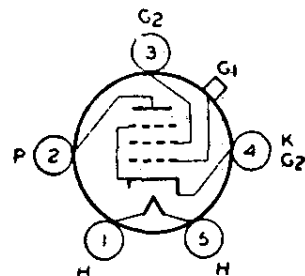

MEDIUM-MU TRIODE

40

Glass type used as resistance-coupled or impedance-coupled amplifier in battery-operated receivers. Outline 29, **OUTLINES SECTION**. Filament volts (dc), 5; amperes, 0.25. Characteristics as class A₁ amplifier: plate supply volts, 180; load resistance, 250000 ohms; grid volts, -3; plate ma., 0.2; plate resistance, 150000 ohms; amplification factor, 30; transconductance, 200 μ mhos. This is a **DISCONTINUED** type listed for reference only.

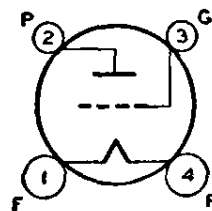

POWER PENTODE

41

Glass type used in output stage of radio receivers. Outline 25, **OUTLINES SECTION**. Tube requires six-contact socket. Heater volts (ac/dc), 6.3; amperes, 0.4. This type is electrically identical with type 6K6-GT.

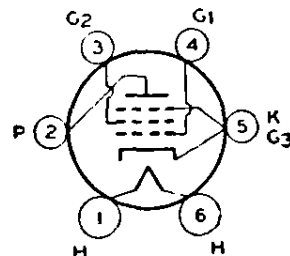

POWER PENTODE

42

Glass type used in audio output stage of avc receivers. Outline 29, **OUTLINES SECTION**. Tube requires six-contact socket. Heater volts (ac/dc), 6.3; amperes, 0.7. This type is electrically identical with type 6F6.

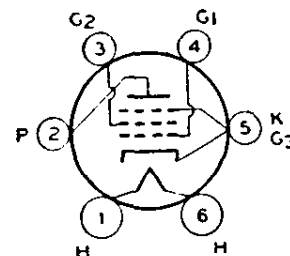

POWER PENTODE

43

Glass type used in audio output stage of ac/dc receivers. Outline 29, **OUTLINES SECTION**. Tube requires six-contact socket. Heater volts (ac/dc), 25; amperes, 0.3. This type is electrically identical with type 25A6.

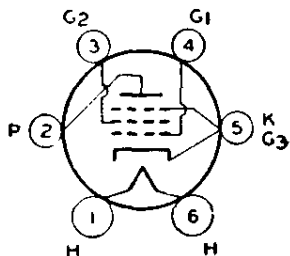

POWER TRIODE

45

Glass type used in output stage of radio receivers. Outline 29, **OUTLINES SECTION**. Tube requires four-contact socket and should be mounted in vertical position. Horizontal operation is permissible if pins 1 and 4 are in vertical plane.

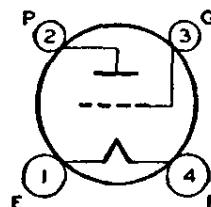

FILAMENT VOLTAGE (AC/DC)	2.5	volts
FILAMENT CURRENT	1.5	amperes

Typical Operation:

CLASS A₁ AMPLIFIER

Plate Voltage (275 volts max)	180	250	275	volts
Grid Voltage*	-31.5	-50	-56	volts
Cathode-Bias Resistor	1020	1470	1550	ohms
Plate Current	31	34	36	ma
Plate Resistance	1650	1610	1700	ohms
Amplification Factor	3.5	3.5	3.5	
Transconductance	2125	2175	2050	μmhos
Load Resistance	2700	3900	4600	ohms
Undistorted Power Output	0.825	1.6	2.0	watts

* Grid volts measured from mid-point of ac-operated filament. Cathode bias is advisable in all cases; required if grid-coupling resistor (max value of 1.0 megohm) is used.

PUSH-PULL CLASS AB₂ AMPLIFIER

Typical Operation (Values are for two tubes):

	<i>Fixed Bias</i>	<i>Cathode Bias</i>	
Plate Voltage (275 volts max)	275	275	volts
Grid Voltage	-68	-	volts
Cathode-Bias Resistor	-	775	ohms
Average Driving Power (Grid-to-grid)	656	460	mw
Zero-Signal Plate Current	28	36	ma
Maximum-Signal Plate Current	138	90	ma
Effective Load Resistance (Plate-to-plate)	3200	5060	ohms
Total Harmonic Distortion	5	5	per cent
Maximum-Signal Power Output	18	12	watts

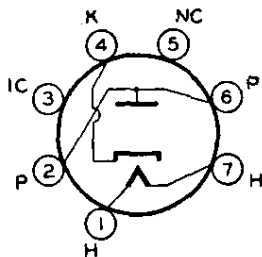

HALF-WAVE VACUUM RECTIFIER

Miniature type used in power supply of small, portable, ac/dc/battery receivers where small size and low heat dissipation are important. Outline 10, OUTLINES SECTION. Tube requires miniature seven-contact socket and may be mounted in any position.

45Z3

HEATER VOLTAGE (AC/DC)	45	volts
HEATER CURRENT	0.075	ampere

Maximum Ratings:

HALF-WAVE RECTIFIER

PEAK INVERSE PLATE VOLTAGE	350 max	volts
PEAK PLATE CURRENT	390 max	ma
DC OUTPUT CURRENT	65 max	ma
PEAK HEATER-CATHODE VOLTAGE:		
Heater negative with respect to cathode	175 max	volts
Heater positive with respect to cathode	175 max	volts

Typical Operation (With Capacitor-Input Filter):

AC Plate Voltage (RMS)	117	volts
Filter-Input Capacitor	16	μf
Minimum Total Effective Plate-Supply Impedance	15	ohms
DC Output Current	65	ma
DC Output Voltage at Input to Filter (Approx.):		
At half-load current (32.5 ma.)	132	volts
At full-load current (65 ma.)	112	volts
Voltage Regulation (Approx.):		
Half-load to full-load current	20	volts

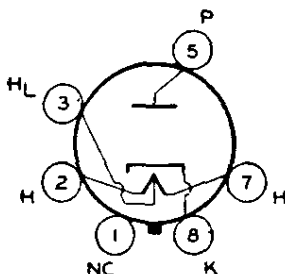

HALF-WAVE VACUUM RECTIFIER

Glass octal type used in power supply of ac/dc receivers. The heater is provided with a tap for operation of a panel lamp. Outline 17, OUTLINES SECTION. Tube requires octal socket. Except for difference in heater voltage, this type has the same ratings and typical operation values as glass-octal type 35Z5-GT.

45Z5-GT

HEATER VOLTAGE (AC/DC):		*	**	
ENTIRE HEATER (PINS 2 AND 7).....	45		42	volts
PANEL LAMP SECTIONS (PINS 2 AND 3).....	7.5		5.5	volts
HEATER CURRENT:				
BETWEEN PINS 2 AND 7.....	0.15		-	ampere
BETWEEN PINS 3 AND 7.....	-		0.15	ampere

* Without panel lamp. ** With No. 40 or No.47 panel lamp.

46

DUAL-GRID POWER AMPLIFIER

Glass type used as class A₁ or class B amplifier in radio equipment. Outline 34, OUTLINES SECTION. Tube requires five-contact socket. Filament volts (ac/dc), 2.5; amperes, 1.75. Typical operation as class A₁ amplifier (grid No.2 connected to plate at socket): plate volts, 250 *max*; grid volts, -33; plate ma., 22; plate resistance, 2380 ohms; am-

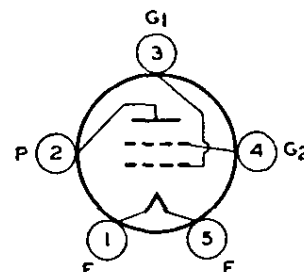

plification factor, 5.6; transconductance, 2350 μ mhos; load resistance for maximum undistorted power output, 6400 ohms; undistorted output watts, 1.25.

PUSH-PULL CLASS B AMPLIFIER

(Grids No.1 and No.2 connected together at socket)

Maximum Ratings:

PLATE VOLTAGE.....	400 <i>max</i>	volts
PEAK PLATE CURRENT.....	200 <i>max</i>	ma
AVERAGE PLATE DISSIPATION.....	10 <i>max</i>	watts

Typical Operation (Values are for two tubes):

Plate Voltage.....	300	400	volts
Grid Voltage.....	0	0	volts
Peak AF Grid-to-Grid Voltage.....	113	116	volts
Zero-Signal Plate Current.....	8	12	ma
Effective Load Resistance (Plate-to-plate).....	5200	5800	ohms
Maximum-Signal Power Output (Approx.).....	16†	20#	watts

† With average power input of 950 milliwatts applied between grids.

With average power input of 650 milliwatts applied between grids.

47

POWER PENTODE

Glass type used in audio output stage of radio receivers. Outline 34, OUTLINES SECTION. Tube requires five-contact socket and should be mounted in vertical position. Horizontal

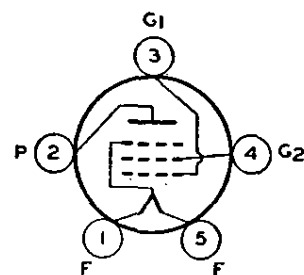

operation is permissible if pins 1 and 5 are in vertical plane. Filament volts (ac/dc), 2.5; amperes, 1.75.

Characteristics:

CLASS A₁ AMPLIFIER

Plate Voltage (250 volts <i>max</i>).....	250	volts
Grid-No.2 (Screen) Voltage (250 volts <i>max</i>).....	250	volts
Grid-No.1 Voltage (Control-Grid)†.....	-16.5	volts
Cathode-Bias Resistor.....	450	ohms
Plate Current.....	31	ma
Grid-No.2 Current.....	6	ma
Plate Resistance.....	60000	ohms
Transconductance.....	2500	μ mhos
Load Resistance.....	7000	ohms
Power Output.....	2.7	watts

† If filament is operated on dc, the grid bias should be -15.3 volts. The dc resistance in the grid circuit should not exceed 0.5 megohm with cathode bias, or 100000 ohms with fixed bias.

POWER TETRODE

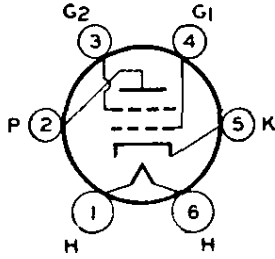

Glass type used in audio output stage of radio receivers designed to operate from dc power lines. Outline 34, OUTLINES SECTION Heater volts (dc), 30; amperes, 0.4. Typical operation as class A₁ amplifier: plate volts, 125 *max*; grid-No.2 volts, 100 *max*; grid-No.1 volts, -20; plate ma., 56; grid-No.2 ma., 9.5; transconductance, 3900 μ mhos; load resistance, 1500 ohms; output watts, 2.5. This is a DISCONTINUED type listed for reference only.

48

DUAL-GRID POWER AMPLIFIER

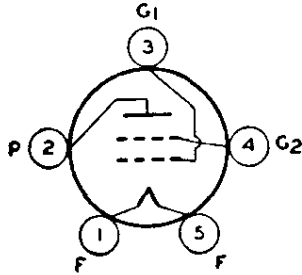

Glass type used in output stage of battery-operated receivers. Outline 29, OUTLINES SECTION. Tube requires five-contact socket. Filament volts (dc), 2.0; amperes, 0.12. Typical operation as class A₁ amplifier (grid No.2 connected to plate at socket): plate volts, 135 *max*; grid volts, -20; plate ma., 6; plate resistance, 4175 ohms; amplification factor, 4.7; transconductance, 1125 μ mhos; load resistance, 11000 ohms; output watts (approx.), 0.17. This type is used principally for renewal purposes.

49

PUSH-PULL CLASS B AMPLIFIER

(Grids No.1 and No.2 connected together at socket.)

Maximum Ratings:

PLATE VOLTAGE.....	180 <i>max</i>	volts
PEAK PLATE CURRENT.....	50 <i>max</i>	ma

Typical Operation (Values are for two tubes):

Plate Voltage.....	135	180	volts
Grid Voltage.....	0	0	volts
Zero-Signal Plate Current.....	2.6	4	ma
Effective Load Resistance (Plate-to-plate).....	8000	12000	ohms
Power Output (Approx.).....	2.3	3.5	watts

POWER TRIODE

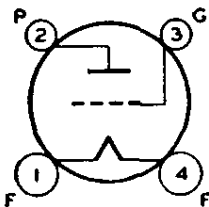

Glass type used in output stage of af amplifiers employing transformer input coupling. Outline 36, OUTLINES SECTION. Tube requires four-contact socket and should be mounted in vertical position with base down. Filament volts (ac/dc), 7.5; amperes, 1.25. Characteristics as class A₁ amplifier: plate volts, 450 *max*; grid volts, -84; cathode resistor, 1530 ohms; plate ma., 55; plate resistance, 1800 ohms; amplification factor, 3.8; transconductance, 2100 μ mhos;

50

load resistance, 4350 ohms; output watts, 4.6. Resistance in grid-coupling circuit should not exceed 10000 ohms. This type is used principally for renewal purposes.

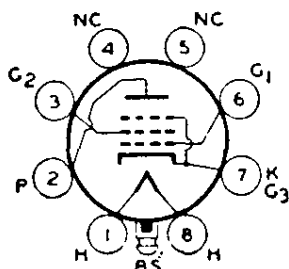

BEAM POWER AMPLIFIER

Glass lock-in type used in output stage of ac/dc receivers. Outline 15, OUTLINES SECTION. Tube requires lock-in socket. Heater volts (ac/dc), 50; amperes, 0.15. For ratings and data, refer to glass-octal type 50L6-GT.

50A5

BEAM POWER AMPLIFIER

50B5

Miniature type used in output stage of compact ac/dc receivers. Because of its high power sensitivity at plate and screen voltages available in ac/dc receivers, it is capable of providing a relatively high power output. Within its maximum ratings, type 50B5 is equivalent in performance to glass-octal type 50L6-GT.

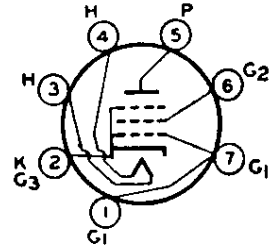

HEATER VOLTS (AC/DC)	50	volts
HEATER CURRENT	0.15	ampere
DIRECT INTERELECTRODE CAPACITANCES (Approx.):*		
Grid No.1 to Plate	0.5	$\mu\mu\text{f}$
Input	13	$\mu\mu\text{f}$
Output	6.5	$\mu\mu\text{f}$

* With no external shield.

Maximum Ratings:

CLASS A₁ AMPLIFIER

PLATE VOLTAGE	117 <i>max</i>	volts
GRID-NO.2 (SCREEN) VOLTAGE	117 <i>max</i>	volts
PLATE DISSIPATION	5.5 <i>max</i>	watts
GRID-NO.2 DISSIPATION	1.25 <i>max</i>	watts
PEAK HEATER-CATHODE VOLTAGE:		
Heater negative with respect to cathode	150 <i>max</i>	volts
Heater positive with respect to cathode	150 <i>max</i>	volts

Typical Operation:

Plate Voltage	110	volts
Grid-No.2 Voltage	110	volts
Grid-No.1 (Control-Grid) Voltage	-7.5	volts
Peak AF Grid-No.1 Voltage	7.5	volts
Zero-Signal Plate Current	49	ma
Maximum-Signal Plate Current	50	ma
Zero-Signal Grid-No.2 Current (Approx.)	4	ma
Maximum-Signal Grid-No.2 Current (Approx.)	8.5	ma
Plate Resistance (Approx.)	10000	ohms
Transconductance	7500	μmhos
Load Resistance	2500	ohms
Total Harmonic Distortion	9	per cent
Maximum-Signal Power Output	1.9	watts

INSTALLATION AND APPLICATION

Type 50B5 requires miniature seven-contact socket and may be mounted in any position. Outline 13, OUTLINES SECTION.

The 50-volt heater is designed to operate under the normal conditions of line-voltage variation without materially affecting the performance or serviceability of the 50B5. For operation of the 50B5 in series with other types having 0.15-ampere rating, the current in the heater circuit should be adjusted to 0.15 ampere for the normal supply voltage.

In a series-heater circuit of the "dc power line" type employing several 0.15-ampere types and one or two 50B5's, the heater(s) of the 50B5('s) should be placed on the positive side of the line. Under these conditions, heater-cathode voltage of the 50B5 must not exceed the value given under maximum ratings. In a series-heater circuit of the "universal" type employing rectifier tube 35W4, one or two 50B5's, and several 0.15-ampere types, it is recommended that the heater(s) of the 50B5's be placed in the circuit so that the higher values of heater-cathode bias will be impressed on the 50B5('s) rather than on the other 0.15-ampere types. This is accomplished by arranging the 50B5('s) on the side of the supply line which is connected to the cathode of the rectifier, i.e., the positive terminal of the rectified

voltage supply. Between this side of the line and the 50B5('s), any necessary auxiliary resistance and the heater of the 35W4 are connected in series.

As a power amplifier (class A₁), the 50B5 is recommended for use either singly or in push-pull combination in the power-output stage of "ac/dc" receivers. The operating values shown under typical operation have been determined on the basis that grid current does not flow during any part of the input cycle. The type of input coupling used should not introduce too much resistance in the grid circuit. Transformer- or impedance-coupling devices are recommended.

When the tube is operated at maximum rated conditions, the grid circuit should have a dc resistance not higher than 0.1 megohm for fixed bias; for higher values, cathode bias is required. With cathode bias, the grid circuit may have a dc resistance as high as, but not higher than, 0.5 megohm.

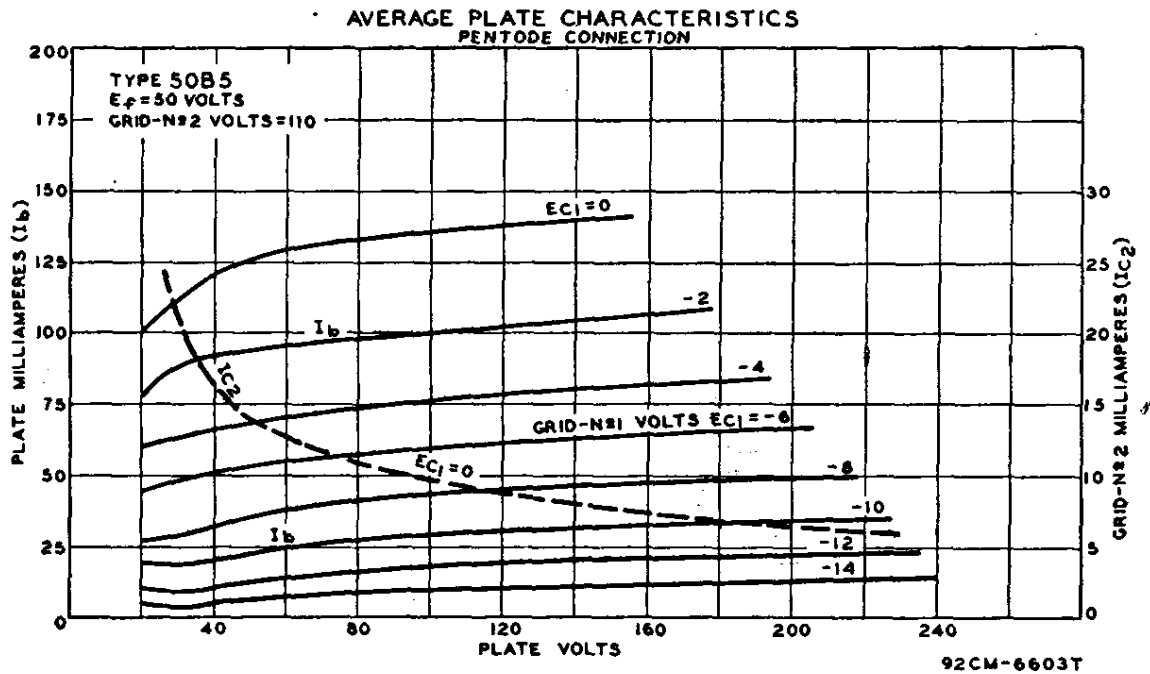

BEAM POWER AMPLIFIER

Glass octal type used in output stage of ac/dc radio receivers. Outline 17, OUTLINES SECTION. Tube requires octal socket and may be mounted in any position. Refer to miniature type 50B5 for curves and installation and application information.

50L6-GT

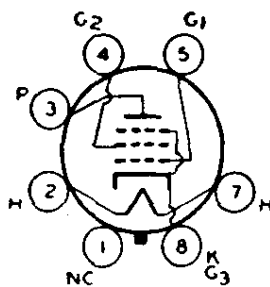

HEATER VOLTAGE (AC/DC).....	50	volts
HEATER CURRENT.....	0.15	ampere
DIRECT INTERELECTRODE CAPACITANCES (Approx.):†		
Grid No.1 to Plate.....	0.8	μf
Input.....	15	μf
Output.....	9.5	μf

† With no external shield.

Maximum Ratings:

CLASS A₁ AMPLIFIER

PLATE VOLTAGE.....	200 max	volts
GRID-NO.2 (SCREEN) VOLTAGE.....	117 max	volts
PLATE DISSIPATION.....	10 max	watts
GRID-NO.2 DISSIPATION.....	1.25 max	watts
PEAK HEATER-CATHODE VOLTAGE:		
Heater negative with respect to cathode.....	150 max	volts
Heater positive with respect to cathode.....	150 max	volts

Typical Operation:

Plate Voltage.....	110	200	volts
Grid-No.2 Voltage.....	110	110	volts
Grid-No.1 (Control-Grid) Voltage.....	-7.5	-8.0	volts
Peak AF Grid-No.1 Voltage.....	7.5	8.0	volts
Zero-Signal Plate Current.....	49	50	ma
Maximum-Signal Plate Current.....	50	55	ma
Zero-Signal Grid-No.2 Current (Approx.).....	4	2	ma
Maximum-Signal Grid-No.2 Current (Approx.).....	11	7	ma
Plate Resistance (Approx.).....	13000	30000	ohms
Transconductance.....	9000	9500	μmhos
Load Resistance.....	2000	3000	ohms
Total Harmonic Distortion.....	10	10	per cent
Maximum-Signal Power Output.....	2.1	4.3	watts

50Y6-GT

VACUUM RECTIFIER-DOUBLER

Glass octal type used as half-wave rectifier or voltage doubler in ac/dc receivers. This type is used particularly in "transformerless" receivers of either the ac/dc type or the voltage-doubler type. Outline 17, OUTLINES SECTION. Tube requires octal socket. Heater volts (ac/dc), 50; amperes, 0.15. Except for heater rating, this type is electrically identical with type 25Z6-GT.

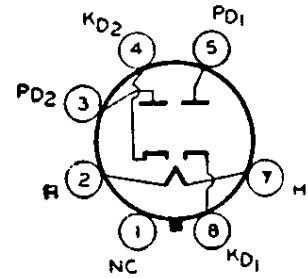

50Z7-G

VACUUM RECTIFIER-DOUBLER

Glass octal type used as half-wave rectifier or voltage doubler in ac/dc receivers. Outline 24, OUTLINES SECTION. The heater is provided with a tap for operation of a panel lamp. Without panel lamp, heater volts (ac/dc) of entire heater (pins 2 and 7), 50; amperes, 0.15. With panel lamp, heater volts (ac/dc) of panel-lamp section (pins 6 and 7 with 0.15 ampere

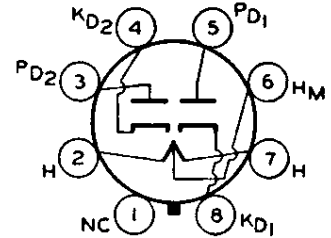

between pins 2 and 7), 2. Maximum ratings as rectifier or doubler: peak inverse plate volts, 700 *max*; peak plate ma. per plate, 400 *max*; dc output ma. per plate with panel lamp, 65 *max*; peak heater-cathode volts, 350 *max*; panel lamp section volts (pins 6 and 7), 2.5 *max*. This is a DISCONTINUED type listed for reference only.

53

HIGH-MU TWIN POWER TRIODE

Glass type used in output stage of ac-operated receivers as a class B power amplifier. Outline 29, OUTLINES SECTION. Tube requires medium seven-contact (0.855-inch pin-circle diameter) socket. Heater volts (ac/dc), 2.5; amperes, 2.0. Except for heater rating, this type is electrically identical with metal type 6N7. Type 53 is used principally for renewal purposes.

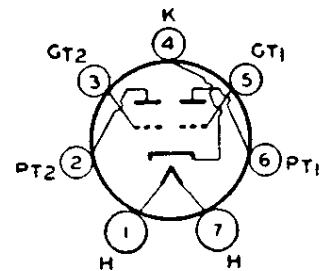

55

TWIN DIODE—MEDIUM-MU TRIODE

Glass type used as a combined detector, amplifier, and avc tube. Outline 27, OUTLINES SECTION. Tube requires six-contact socket. Heater volts (ac/dc), 2.5; amperes, 1.0. Except for heater rating, this type is electrically identical with glass type 85. Type 55 is used principally for renewal purposes.

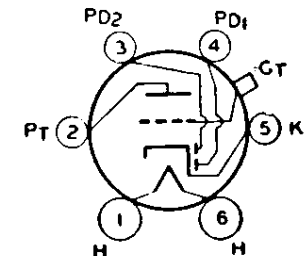

56

MEDIUM-MU TRIODE

Glass type used as detector, amplifier, or oscillator in ac-operated receivers. Outline 25, OUTLINES SECTION. Tube requires five-contact socket. Heater volts (ac/dc), 2.5; amperes, 1.0. Except for heater rating, this type is electrically identical with glass type 76. Type 56 is used principally for renewal purposes.

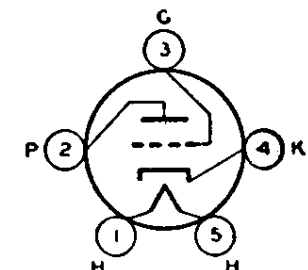

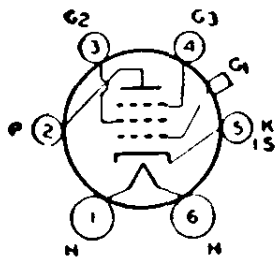

SHARP-CUTOFF PENTODE

Glass type used as biased detector in ac-operated receivers. Outline 31, OUTLINES SECTION. Tube requires six-contact socket. Heater volts (ac/dc), 2.5; amperes, 1.0. Except for heater rating and capacitances, this type is electrically identical with metal type 6J7. Type 57 is used principally for renewal purposes.

57

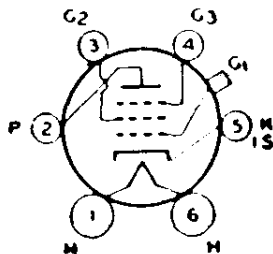

REMOTE-CUTOFF PENTODE

Glass type used in rf and if stages of radio receivers employing avc and as a mixer in super-heterodyne circuits. Outline 31, OUTLINES SECTION. Tube requires six-contact socket. Heater volts (ac/dc), 2.5; amperes, 1.0. Except for heater ratings, this type is electrically identical with glass-octal type 6U7-G. Type 58 is used principally for renewal purposes.

58

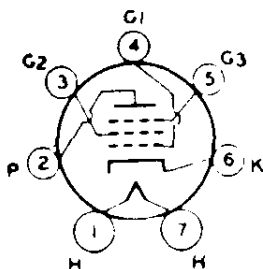

TRIPLE-GRID POWER AMPLIFIER

Glass type used in audio output stage of ac-operated receivers. Outline 34, OUTLINES SECTION. Tube requires medium seven-contact (0.855-inch, pin-circle diameter) socket. Heater volts (ac/dc), 2.5; amperes, 2.0. Typical operation as class A₁ amplifier (triode connection; grids No.2 and No.3 tied to plate): plate volts, 250 max; grid volts, -28; plate ma., 26;

59

plate resistance, 2300 ohms; amplification factor, 6; transconductance, 2600; load resistance for maximum undistorted power output, 5000 ohms; undistorted output watts, 1.25. For typical operation as class A₁ amplifier (pentode connection; grid No.3 tied to cathode at socket), refer to type 6F6 with plate voltage of 250 volts. This type is used principally for renewal purposes.

Maximum Ratings:

CLASS B AMPLIFIER—Triode Connection*

PLATE VOLTAGE	400 max	volts
PEAK PLATE CURRENT	200 max	ma
PLATE DISSIPATION	10 max	watts
GRID DISSIPATION (GRIDS NO.1 AND NO.2)	1.5 max	watts

Typical Operation (Values are for two tubes):

Plate Voltage	300	400	volts
Grid Voltage	0	0	volts
Zero-Signal Plate Current	20	26	ma
Effective Load Resistance (Plate-to-plate)	4600	6000	ohms
Power Output (Approx.)	15	20	watts

* Grid No.3 tied to plate; grids No.1 and No.2 tied together.

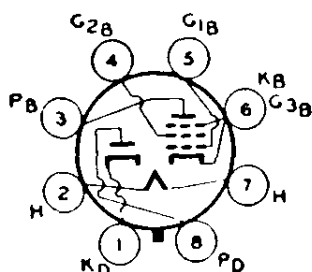

RECTIFIER—BEAM POWER AMPLIFIER

Glass octal type used as combined half-wave rectifier and output amplifier in ac/dc receivers. Outline 21, OUTLINES SECTION. Tube requires octal socket. Heater volts (ac/dc), 70; amperes, 0.15. Maximum ratings of rectifier unit: peak inverse plate volts, 350; peak plate ma., 420; dc output ma., 70; peak heater-cathode volts, 175; minimum total effective

70L7-GT

plate-supply impedance, 15 ohms. Typical operation and maximum ratings of beam power unit as class A₁ amplifier: plate and grid-No.2 volts, 110 (117 max); grid-No.1 volts, -7.5; plate ma., 40; grid-No.2 ma., 3; plate resistance, 15000 ohms; transconductance, 7500 μmhos; load resistance, 2000 ohms; output watts, 1.8; plate dissipation, 5 max watts; grid-No.2 dissipation, 1 max watt.

POWER TRIODE

71-A

Glass type used in output stage of audio-frequency amplifiers. Outline 29, OUTLINES SECTION. Tube requires four-contact socket. Filament volts (ac/dc), 5.0; amperes, 0.25. Characteristics as class A₁ amplifier: plate volts, 180 *max*; grid volts, -40.5; cathode resistor, 2150 ohms; plate ma., 20; plate resistance, 1750 ohms; amplification factor, 3; transconductance,

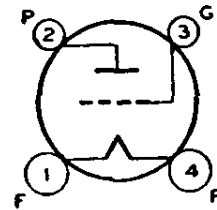

1700 μ mhos; load resistance, 4800 ohms; undistorted output watts, 0.79. This type is used principally for renewal purposes.

TWIN DIODE—HIGH-MU TRIODE

75

Glass type used as combined detector, amplifier, and avc tube in radio receivers. Outline 27, OUTLINES SECTION. Tube requires six-contact socket. Heater volts (ac/dc), 6.3; amperes, 0.3. Except for interelectrode capacitances and plate volts of 250 *max*, this type is identical electrically with metal type 6SQ7. Type 75 is used principally for renewal purposes.

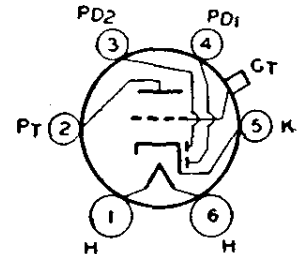

MEDIUM-MU TRIODE

76

Glass type used as voltage amplifier or detector in radio receivers. Outline 25, OUTLINES SECTION. Tube requires five-contact socket. Heater volts (ac/dc), 6.3; amperes, 0.3. Characteristics as class A₁ amplifier: plate volts, 250 *max*; grid volts, -13.5; plate ma., 5; plate resistance, 9500 ohms; transconductance, 1450 μ mhos. For typical operation as a resistance-

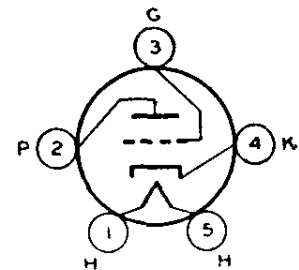

coupled amplifier, refer to Chart 23, RESISTANCE-COUPLED AMPLIFIER SECTION. This type is used principally for renewal purposes.

SHARP-CUTOFF PENTODE

77

Glass type used as biased detector or high-gain amplifier in radio receivers. Outline 27, OUTLINES SECTION. Tube requires six-contact socket. Heater volts (ac/dc), 6.3; amperes, 0.3. Except for capacitances and grid-No. 2 rating of 100 *max* volts, type 77 is electrically identical with metal type 6J7. This type is used principally for renewal purposes.

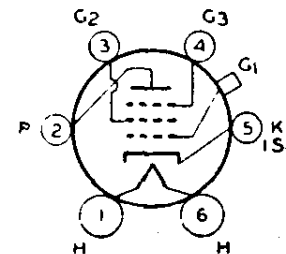

REMOTE-CUTOFF PENTODE

78

Glass type used in rf and if stages of radio receivers, particularly those employing avc. Outline 27, OUTLINES SECTION. Tube requires six-contact socket. Heater volts (ac/dc), 6.3; amperes, 0.3. Except for capacitances, this type is identical electrically with metal type 6K7. Type 78 is used principally for renewal purposes.

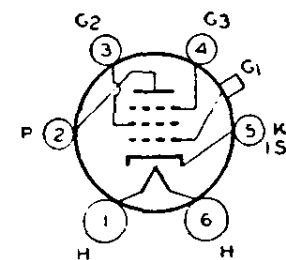

HIGH-MU TWIN POWER TRIODE

79

Glass type used in output stage of radio receivers as a class B power amplifier or a class A₁ driver. Outline 27, OUTLINES SECTION. Tube requires six-contact socket. Heater volts (ac/dc), 6.3; amperes, 0.6. Maximum ratings and typical operation as class B power amplifier: plate volts, 250 *max*; grid volts, 0; zero-signal plate ma., 10.5; effective load resistance

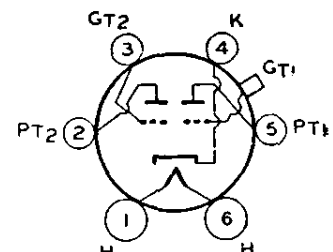

(plate-to-plate), 14000 ohms; output watts (approx.), 8; peak plate ma. per plate, 90 *max*; average plate dissipation, 11.5 watts *max*. For typical operation as a resistance-coupled amplifier, refer to Chart 24, RESISTANCE-COUPLED AMPLIFIER SECTION. This type is used principally for renewal purposes.

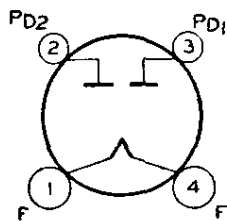

FULL-WAVE VACUUM RECTIFIER

80

Glass type used in power supply of radio equipment having moderate direct-current requirements. Outline 29, OUTLINES SECTION. Tube requires four-contact socket and should be mounted preferably in a vertical position. Horizontal mounting is permissible if pins 1 and 4 are in a horizontal plane. Filament volts (ac), 5.0; amperes, 2.0. For filament operation, refer to type 5U4-G. Type 80 is electrically identical with glass-octal type 5Y3-GT.

HALF-WAVE VACUUM RECTIFIER

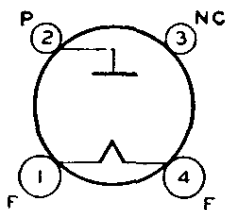

81

Glass type used in power supply of radio receivers. Outline 36, OUTLINES SECTION. Tube requires four-contact socket and should be mounted preferably in a vertical position. Horizontal mounting is permissible if pins 1 and 4 are in a vertical plane. Filament volts (ac), 7.5; amperes, 1.25. Ratings as half-wave rectifier: peak inverse plate volts, 2000 *max*; peak plate ma., 500 *max*; dc output ma., 85 *max*. This type is used principally for renewal purposes.

FULL-WAVE MERCURY-VAPOR RECTIFIER

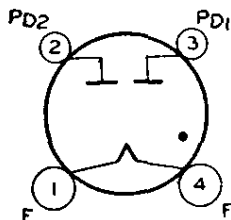

**82
83**

Glass types used to supply dc power of uniform voltage to receivers in which the rectified current requirements are subject to considerable variation. Outlines 29 and 34, respectively, OUTLINES SECTION. Tube requires four-contact socket and should be mounted in vertical position with base down.

	<i>Type 82</i>	<i>Type 83</i>	
FILAMENT VOLTAGE (AC).....	2.5	5	volts
FILAMENT CURRENT.....	3	3	amperes

Maximum Ratings:

FULL-WAVE RECTIFIER

PEAK INVERSE PLATE VOLTAGE.....	1550 <i>max</i>	1550 <i>max</i>	volts
PEAK PLATE CURRENT PER PLATE.....	0.6 <i>max</i>	1.0 <i>max</i>	ampere
DC OUTPUT CURRENT.....	115 <i>max</i>	225 <i>max</i>	ma
CONDENSED-MERCURY TEMPERATURE RANGE.....	24 to 60	20 to 60	°C

Typical Operation (With Capacitor-Input Filter):

AC Plate-to-Plate Supply Voltage (RMS).....	900	900	volts
Minimum Total Effective Plate-Supply Impedance per Plate†.....	50	50	ohms
DC Output Current.....	115	225	ma

Typical Operation (With Choke-Input Filter):

AC Plate-to-Plate Supply Voltage (RMS).....	1100	1100	volts
Minimum Filter-Input Choke.....	6	3	henries
DC Output Current.....	115	225	ma

† When a filter-input capacitor larger than 40 μ f is used, it may be necessary to use more plate-supply impedance than the minimum value shown to limit the peak plate current to the rated value.

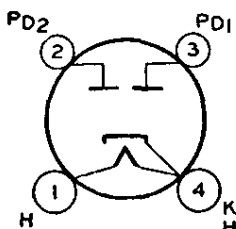

FULL-WAVE VACUUM RECTIFIER

83-v

Glass type used in power supply of radio equipment having high dc requirements. Outline 29, OUTLINES SECTION. Tube requires four-contact socket. Heater volts (ac), 5.0; amperes, 2. This type is identical electrically with glass-octal type 5V4-G.

84/6Z4

FULL-WAVE VACUUM RECTIFIER

Glass type used in power supply of automobile and ac-operated radio receivers. Outline 25, OUTLINES SECTION. Tube requires five-contact socket. Heater volts (ac/dc), 6.3; amperes, 0.5. Maximum ratings: peak inverse plate volts, 1250 *max*; peak plate ma., 180 *max*; dc output ma., 60 *max*; peak heater-cathode volts, 450 *max*. Typical operation with capacitor-

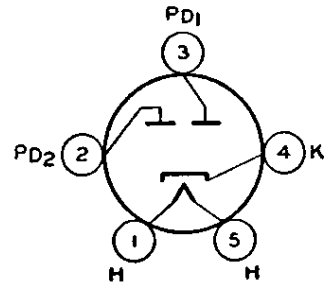

input filter: ac plate-to-plate supply volts (RMS), 650; minimum total effective plate supply impedance per plate, 150 ohms; dc output ma., 60. Typical operation with choke-input filter: ac plate-to-plate supply volts (RMS), 900; minimum filter-input choke, 10 henries; dc output ma., 60. This type is used principally for renewal purposes.

85

TWIN DIODE—MEDIUM-MU TRIODE

Glass type used as a combined detector, amplifier, and avc tube. Outline 27, OUTLINES SECTION. Tube requires six-contact socket. Heater volts (ac/dc), 6.3; amperes, 0.3. Characteristics of triode unit as class A₁ amplifier: plate volts, 250 *max*; grid volts, -20; amplification factor, 8.3; transconductance, 1100 μ mhos; plate ma., 8.0; plate resistance, 7500 ohms; load

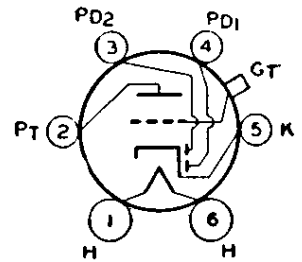

resistance, 20000 ohms; output watts, 0.35. For typical operation as a resistance-coupled amplifier, refer to Chart 22, RESISTANCE-COUPLED AMPLIFIER SECTION. This type is used principally for renewal purposes.

89

TRIPLE-GRID POWER AMPLIFIER

Glass type used in output stage of radio receivers. Outline 27, OUTLINES SECTION. Tube requires six-contact socket. Heater volts (ac/dc), 6.3; amperes, 0.4. Maximum rating: as class B amplifier (triode connection): plate volts, 250 *max*; peak plate ma. per tube, 90 *max*; average grid dissipation of grids No.1 and No.2 tied together, 0.35 *max* watt. This type is used principally for renewal purposes.

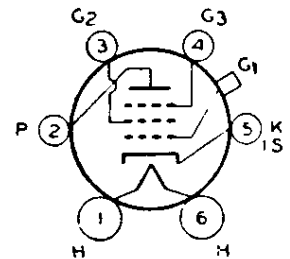

CLASS A₁ AMPLIFIER

Typical Operation:

	Triode Connection*	Pentode Connection**	
Plate Voltage (250 <i>max</i>)	180	180	volts
Grid-No.2 (Screen) Voltage (250 <i>max</i>)	-	180	volts
Grid-No.1 (Control-Grid) Voltage	-22.5	-18	volts
Cathode Resistor	1125	785	ohms
Plate Current	20	20	ma
Grid-No.2 Current	-	3	ma
Amplification Factor	4.7	-	
Plate Resistance	3000	8000	ohms
Transconductance	1550	1550	μ mhos
Load Resistance	6500†	8000	ohms
Power Output	0.4	1.5	watts

* Grids No.2 and No.3 tied to plate.

** Grid No.3 tied to cathode.

† Optimum for maximum undistorted power output of 0.4 watt.

CLASS B AMPLIFIER (Triode Connection)†

Typical Operation (Values are for two tubes):

Plate Voltage	180	volts
Grid Voltage	0	volts
Peak AF Grid-to-Grid Voltage	68	volts
Zero-Signal Plate Current	6	ma
Effective Load Resistance (Plate-to-plate)	9400	ohms
Total Harmonic Distortion	8	per cent
Power Output (Approx.)	3.5	watts

† Grids No.1 and No.2 tied together; grid No.3 tied to plate.

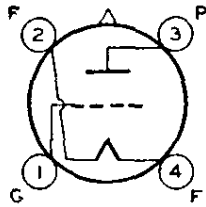

DETECTOR AMPLIFIER TRIODE

Glass types used as detector or amplifier in battery-operated receivers. Filament volts (dc), 3.0 to 3.3; amperes, 0.060 to 0.063. Characteristics as class A₁ amplifier: plate volts, 90 *max*; grid volts, -4.5; amplification factor, 6.6; transconductance, 425 μ mhos; plate ma., 2.5. Operation as grid-resistor detector: plate volts, 45; grid resistor, 0.25 to 5 megohms; grid capacitor, 250 μ mf; grid return to (+) filament. Operation as biased detector: plate volts, 90 *max*; grid volts (approx.), -10.5. These are DISCONTINUED types listed for reference only.

V99

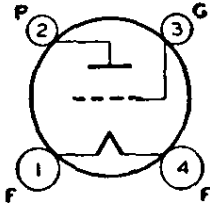

X99

DETECTOR AMPLIFIER TRIODE

Glass type used as detector or amplifier in battery-operated receivers. Outline 29, OUTLINES SECTION. Filament volts (dc), 5.0; amperes, 0.25. Operation as class A₁ amplifier: plate volts, 180 *max*; grid volts, -13.5; amplification factor, 8.5; transconductance, 1800 μ mhos; plate ma., 7.7; load resistance, 10650 ohms; output watts, 0.285. Operation as biased detector: plate volts, 180; grid volts, -21. This is a DISCONTINUED type listed for reference only.

112-A

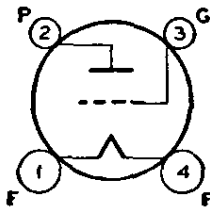

RECTIFIER—BEAM POWER AMPLIFIER

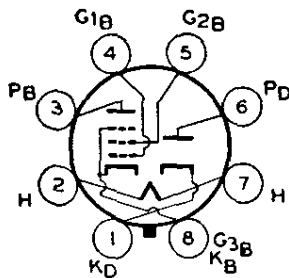

Glass octal type used as combined half-wave rectifier and output amplifier in ac/dc receivers. Outline 21, OUTLINESSECTION. Tuberequires octal socket. Heater volts (ac/dc), 117; amperes, 0.09. For ratings and operation of rectifier unit, refer to type 117N7-GT.

**117L7/
M7-GT**

Maximum Ratings:

AMPLIFIER UNIT AS CLASS A₁ AMPLIFIER

PLATE VOLTAGE.....	117 <i>max</i>	volts
GRID-NO.2 (SCREEN) VOLTAGE.....	117 <i>max</i>	volts
PLATE DISSIPATION.....	6.0 <i>max</i>	watts
GRID-NO.2 DISSIPATION.....	1.0 <i>max</i>	watt

Typical Operation:

PLATE VOLTAGE.....	105	volts
Grid-No.2 Voltage.....	105	volts
Grid-No.1 (Control-Grid) Voltage.....	-5.2	volts
Peak AF Grid-No.1 Voltage.....	5.2	volts
Zero-Signal Plate Current.....	43	ma
Maximum-Signal Plate Current.....	43	ma
Zero-Signal Grid-No.2 Current (Approx.).....	4	ma
Maximum-Signal Grid-No.2 Current (Approx.).....	5.5	ma
Plate Resistance (Approx.).....	17000	ohms
Transconductance.....	5300	μ mhos
Load Resistance.....	4000	ohms
Total Harmonic Distortion.....	5	per cent
Maximum-Signal Power Output.....	0.85	watt

**RECTIFIER—BEAM POWER
AMPLIFIER**

117N7-GT

Glass octal type used as combined half-wave rectifier and output amplifier in ac/dc receivers. Outline 21, OUTLINES SECTION. Tube requires octal socket and may be mounted in

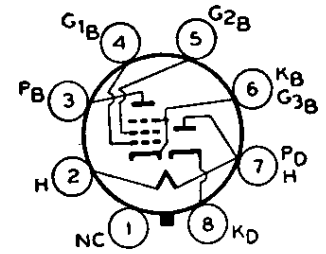

any position. Heater volts (ac/dc), 117; amperes, 0.09. When the amplifier unit is operated at maximum rated conditions, the grid circuit should have a dc resistance not higher than 0.25 megohm for fixed bias; for higher values, cathode bias is required. With cathode bias, the grid circuit may have a dc resistance as high as, but not higher than, 1.0 megohm.

RECTIFIER UNIT AS HALF-WAVE RECTIFIER

Maximum Ratings:

PEAK INVERSE PLATE VOLTAGE.....	350 max	volts
PEAK PLATE CURRENT.....	450 max	ma
DC OUTPUT CURRENT.....	75 max	ma
PEAK HEATER-CATHODE VOLTAGE:		
Heater negative with respect to cathode.....	175 max	volts

Typical Operation (Capacitor-Input Filter):

AC Plate-Supply Voltage (RMS).....	117	volts
Filter-Input Capacitor.....	40	μ f
Minimum Total Effective Plate-Supply Impedance†.....	15	ohms
DC Output Current.....	75	ma
DC Output Voltage at Input to Filter (Approx.).....	122	volts

† When a filter-input capacitor larger than 40 μ f is used, it may be necessary to use more plate-supply impedance than the minimum value shown to limit the peak plate current to the rated value.

AMPLIFIER UNIT AS CLASS A₁ AMPLIFIER

Maximum Ratings:

PLATE VOLTAGE.....	117 max	volts
GRID-NO.2 (SCREEN) VOLTAGE.....	117 max	volts
PLATE DISSIPATION.....	5.5 max	watts
GRID-NO.2 DISSIPATION.....	1.0 max	watt

Typical Operation:

Plate Voltage.....	100	volts
Grid-No.2 Voltage.....	100	volts
Grid-No.1 (Control-Grid) Voltage.....	-6	volts
Peak AF Grid-No.1 Voltage.....	6	volts
Zero-Signal Plate Current.....	51	ma
Zero-Signal Grid-No.2 Current.....	5	ma
Plate Resistance (Approx.).....	16000	ohms
Transconductance.....	7000	μ mhos
Load Resistance.....	3000	ohms
Total Harmonic Distortion.....	6	per cent
Maximum-Signal Power Output.....	1.2	watts

**RECTIFIER—BEAM POWER
AMPLIFIER**

117P7-GT

Glass octal type used as combined half-wave rectifier and output tube. Outline 21, OUTLINES SECTION. Tube requires octal socket. Heater volts (ac/dc), 117; amperes, 0.09. This tube is electrically identical with glass-octal type 117L7/M7-GT.

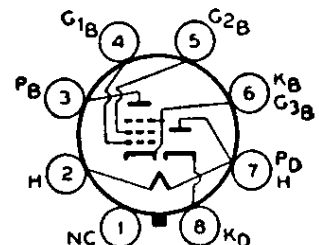

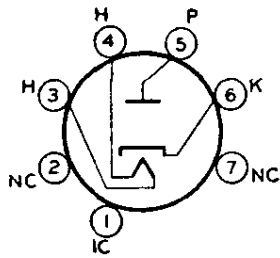

HALF-WAVE VACUUM RECTIFIER

Miniature type used in power supply of ac/dc/battery radio receivers. The heater is designed for operation directly across a 117-volt ac or dc supply line.

117Z3

HEATER VOLTAGE (AC/DC).....	117	volts
HEATER CURRENT.....	0.04	ampere

Maximum Ratings:

HALF-WAVE RECTIFIER

PEAK INVERSE PLATE VOLTAGE.....	330 max	volts
PEAK PLATE CURRENT.....	540 max	ma
DC OUTPUT CURRENT.....	90 max	ma
PEAK HEATER-CATHODE VOLTAGE:		
Heater negative with respect to cathode.....	330 max	volts
Heater positive with respect to cathode.....	165 max	volts

Typical Operation (Capacitor-Input to Filter):

AC Plate-Supply Voltage (RMS).....	117	volts
Filter-Input Capacitor.....	40	μ f
Minimum Total Effective Plate-Supply Impedance†.....	15	ohms
DC Output Current.....	90	ma
DC Output Voltage at Input to Filter (Approx):		
At half-load current (45 ma.).....	120	volts
At full-load current (90 ma.).....	100	volts
Voltage Regulation (Approx.):		
Half-load to full-load current.....	20	volts

† When a filter-input capacitor larger than 40 μ f is used, it may be necessary to use more plate-supply impedance than the minimum value shown to limit the peak plate current to the rated value.

INSTALLATION AND APPLICATION

Type 117Z3 requires miniature seven-contact socket and may be mounted in any position. Outline 13, OUTLINES SECTION. It is especially important that this tube, like other power-handling tubes, should be adequately ventilated.

Refer to the CIRCUITS SECTION for typical application of the 117Z3 as a half-wave rectifier in a portable 3-way superheterodyne receiver.

OPERATION CHARACTERISTICS

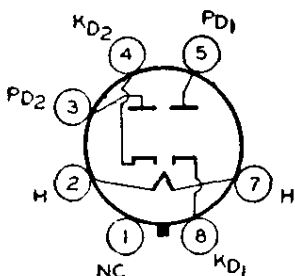
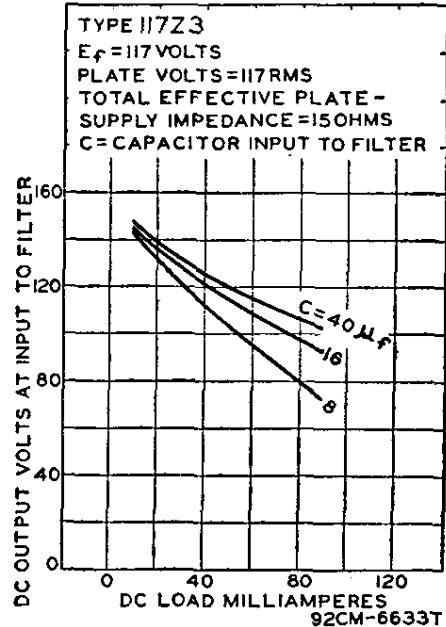

VACUUM RECTIFIER-DOUBLER

Glass octal type used as half-wave rectifier or voltage doubler in ac/dc receivers. Outline 17, OUTLINES SECTION. Tube requires octal socket and may be mounted in any position. Heater volts (ac/dc), 117; amperes, 0.075.

117Z6-GT

HALF-WAVE RECTIFIER

Maximum Ratings:

PEAK INVERSE PLATE VOLTAGE.....	700 <i>max</i>	volts
PEAK PLATE CURRENT PER PLATE.....	360 <i>max</i>	ma
DC OUTPUT CURRENT PER PLATE.....	60 <i>max</i>	ma
PEAK HEATER-CATHODE VOLTAGE.....	350 <i>max</i>	volts

Typical Operation (Capacitor-Input Filter):^o

AC Plate-Supply Voltage per Plate (RMS).....	117	150	235	volts
Filter-Input Capacitor.....	40	40	40	μ f
Minimum Total Effective Plate-Supply Impedance per Plate [†]	15	40	100	ohms
DC Output Current per Plate.....	60	60	60	ma

VOLTAGE DOUBLER

Maximum Ratings:

(Same as for Half-Wave Rectifier)

Typical Operation:

	<i>Half-Wave</i>	<i>Full-Wave</i>	
AC Plate-Supply Voltage per Plate (RMS).....	117	117	volts
Filter-Input Capacitor.....	40	40	μ f
Minimum Total Effective Plate-Supply Impedance per Plate [†] ..	30	15	ohms
DC Output Current.....	60	60	ma

^o In half-wave rectifier service, the two units may be used separately or in parallel.

[†] When a filter-input capacitor larger than 40 μ f is used, it may be necessary to use more plate-supply impedance than the minimum value shown to limit the peak plate current to the rated value.

POWER TRIODE

183/483

Glass type used in output stage of radio receivers. Outline 29, **OUTLINES SECTION**. Filament volts (ac/dc), 5.0; amperes, 1.25. Characteristics: plate volts, 250; grid volts, -60; plate ma., 30; amplification factor, 3; plate resistance, 1750 ohms; transconductance, 1700 μ mhos; load resistance, 5000 ohms; output watts, 1.8. This is a **DISCONTINUED** type listed for reference only.

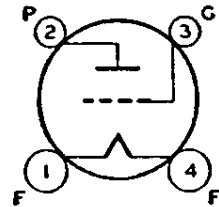

DETECTOR AMPLIFIER TRIODE

485

Glass type used as detector or class A₁ amplifier in radio receivers. Outline 25, **OUTLINES SECTION**. Heater volts (ac/dc), 3; amperes, 1.25. Characteristics: plate volts, 180; grid volts, -9; amplification factor, 12.5; plate resistance, 8900 ohms; transconductance, 1400 μ mhos; plate ma., 5.8. This is a **DISCONTINUED** type listed for reference only.

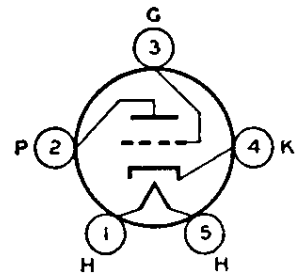

CURRENT REGULATORS

876

886

Constant-current regulating devices (ballast tubes) used in radio receivers. Bases fit the standard mogul screw socket and tubes may be mounted in any position. Tubes operate at high bulb temperature. They must be surrounded by a protective metal ventilating stack. Operating conditions: voltage range, 40 to 60 volts; ambient temperature, 150°F; operating current for the 876, 1.7 amperes; for the 886, 2.05 amperes. These are **DISCONTINUED** types listed for reference only.

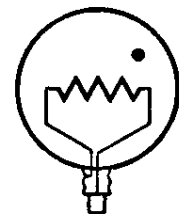

- 1 – Metal Envelope
- 2 – Spacer Shield
- 3 – Insulating Spacer
- 4 – Mount Support
- 5 – Control Grid
- 6 – Coated Cathode
- 7 – Screen
- 8 – Heater
- 9 – Suppressor
- 10 – Plate
- 11 – Batalum Getter
- 12 – Conical Stem Shield
- 13 – Header
- 14 – Glass Seal
- 15 – Header Insert
- 16 – Glass-Button Stem Seal
- 17 – Cylindrical Base Shield
- 18 – Header Skirt
- 19 – Lead Wire
- 20 – Crimped Lock
- 21 – Octal Base
- 22 – Exhaust Tube
- 23 – Base Pin

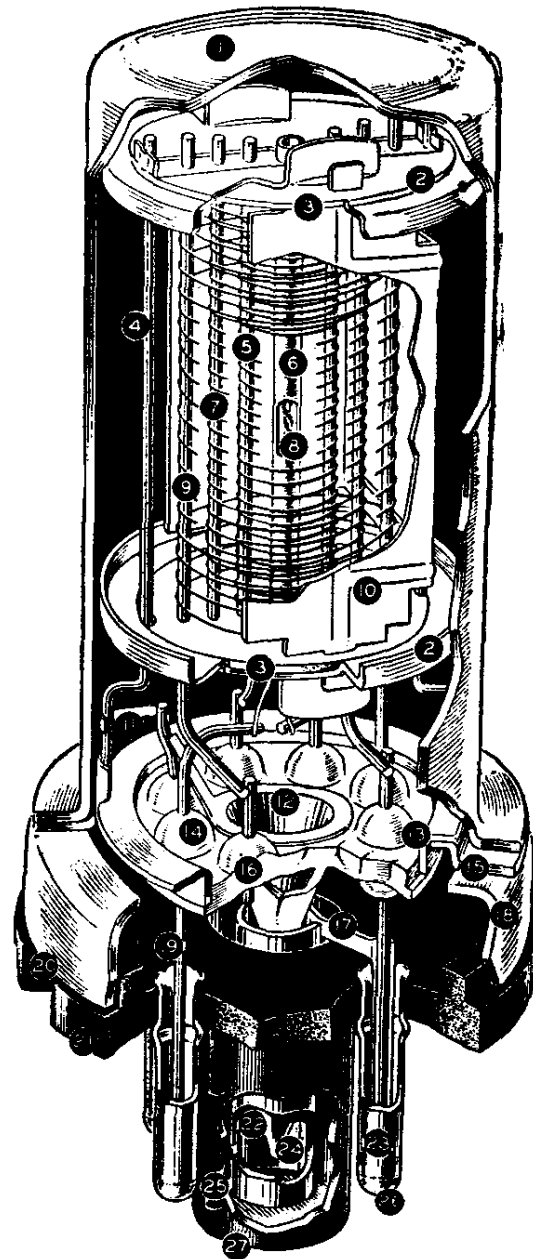

1 3/4 times actual size

- 24 – Exhaust Tip
- 25 – Aligning Key
- 26 – Solder
- 27 – Aligning Plug

Structure of a Metal Tube

Electron Tube Testing

The electron tube user—service man, experimenter, or non-technical radio listener—is interested in knowing the condition of his tubes, since they govern the performance of the device in which they are used. In order to determine the condition of a tube, some method of test is necessary. Because the operating capabilities and design features of a tube are indicated and described by its electrical characteristics, a tube is tested by measuring its characteristics and comparing them with values established as standard for that type. Tubes which read abnormally high with respect to the standard for the type are subject to criticism just the same as tubes which are too low.

Certain practical limitations are placed on the accuracy with which a tube test can be correlated with actual tube performance. These limitations make it unnecessary for the service man and dealer to employ complex and costly testing equipment having laboratory accuracy. Because the accuracy of the tube-testing device need be no greater than the accuracy of the correlation between test results and receiver performance, and since certain fundamental characteristics are virtually fixed by the manufacturing technique of leading tube manufacturers, it is possible to employ a relatively simple test in order to determine the serviceability of a tube.

In view of these factors, dealers and service men will find it economically expedient to obtain adequate accuracy and simplicity of operation by employing a device which indicates the status of a single characteristic. Whether the tube is satisfactory or unsatisfactory is judged from the test result of this single characteristic. Consequently, it is very desirable that the characteristic selected for the test be one which is truly representative of the tube's overall condition.

The following information and circuits are given to describe and illustrate general theoretical and practical tube-tester considerations and not to provide information on the construction of a home-made tube tester. In addition to the problem of determining what tube characteristic is most representative of performance capabilities in all types of receivers, the designer of a home-made tester faces the difficult problem of determining satisfactory limits for his particular tester. The obtaining of information of this nature, if it is to be accurate and useful, is a tremendous job. It requires the testing of a large number of tubes of each type, the testing of many types, and the correlation of these readings with performance in many kinds of equipment.

SHORT CIRCUIT TEST

The fundamental circuit of a short-circuit tester is shown in Fig. 74. Although this circuit is suitable for tetrodes and types having less than four electrodes, tubes of more electrodes may be tested by adding more indicator lamps to the circuit. Voltages are applied between the various electrodes with lamps in series with the electrode leads. The value of the voltages applied will depend on the type of tube being tested. Any two shorted electrodes complete a circuit and light one or more lamps. Since two electrodes may be just touching to give a high-resistance short, it is desirable that the indicating lamps operate on very low current. It is also desirable to maintain the filament or heater of the

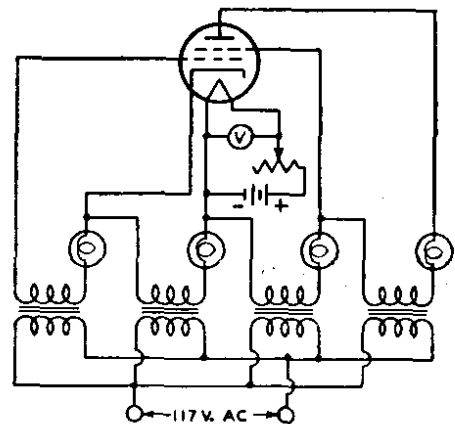

Fig. 74

tube at its operating temperature during the short-circuit test, because short-circuits in a tube may sometimes occur only when the electrodes are heated.

SELECTION OF A SUITABLE CHARACTERISTIC FOR TEST

Some characteristics of a tube are far more important in determining its operating worth than are others. The cost of building a device to measure any one of the more important characteristics may be considerably higher than that of a device which measures a less representative characteristic. Consequently, three methods of test will be discussed, ranging from relatively simple and inexpensive equipment to more elaborate, more accurate, and more costly devices.

An **emission test** is perhaps the simplest method of indicating a tube's condition. (Refer to **Diodes**, in **ELECTRONS, ELECTRODES, AND ELECTRON TUBES SECTION**, for a discussion of electron emission.) Since emission falls off as the tube wears out, low emission is indicative of the end of tube serviceability. However, the emission test is subject to limitations because it tests the tube under static conditions and does not take into account the actual operation of the tube. On the one hand, coated filaments, or cathodes, often develop active spots from which the emission is so great that the relatively small grid area adjacent to these spots cannot control the electron stream. Under these conditions, the total emission may indicate the tube to be normal although the tube is unsatisfactory. On the other hand, coated types of filaments are capable of such large emission that the tube will often operate satisfactorily after the emission has fallen far below the original value.

Fig. 75 shows the fundamental circuit diagram for an emission test. All of the electrodes of the tube, except the cathode, are connected to the plate. The filament, or heater, is operated at rated voltage; after the tube has reached constant temperature, a low positive voltage is applied to the plate and the electron emission is read on the meter. Readings which are well below the average for a particular tube type indicate that the total number of available electrons has been so reduced that the tube is no longer able to function properly.

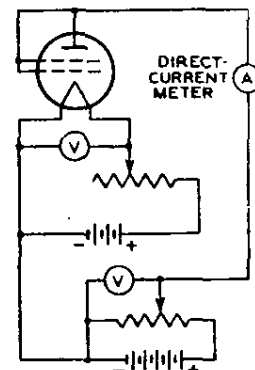

Fig. 75

A **transconductance test** takes into account a fundamental operating principle of the tube. (This will be seen from the definition of transconductance in the Section on **ELECTRON TUBE CHARACTERISTICS**.) It follows that transconductance tests when properly made, permit better correlation between test results and actual performance than does a straight emission test.

There are two forms of transconductance test which can be utilized in a tube tester. In the first form (illustrated by Fig. 76 giving a fundamental circuit with a tetrode under test), appropriate operating voltages are applied to the electrodes of the tube. A plate current depending upon the electrode voltages, will then be indicated by the meter. If the bias on the grid is then shifted by the application of a different grid voltage, a new plate-current reading is obtained. The difference between the two plate-current readings is indicative of the transconductance of the tube. This method of transconductance testing is commonly called the "grid-shift" method, and depends on readings under static conditions. The fact that this form of test is made under static conditions imposes limitations not encountered in the second form of test made under dynamic conditions.

The dynamic transconductance test illustrated in Fig. 77 gives a fundamental circuit with a tetrode under test. This method is superior to the static transconductance test in that ac voltage is applied to the grid. Thus, the tube is tested

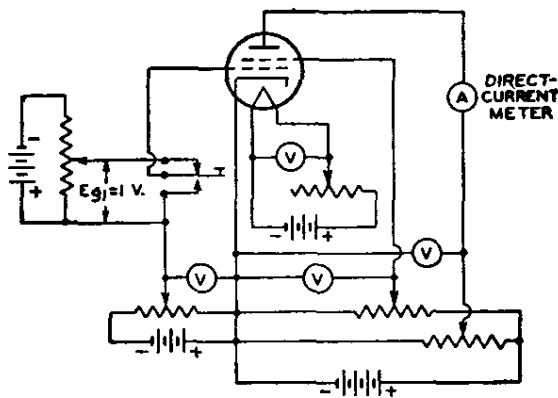

Fig. 76

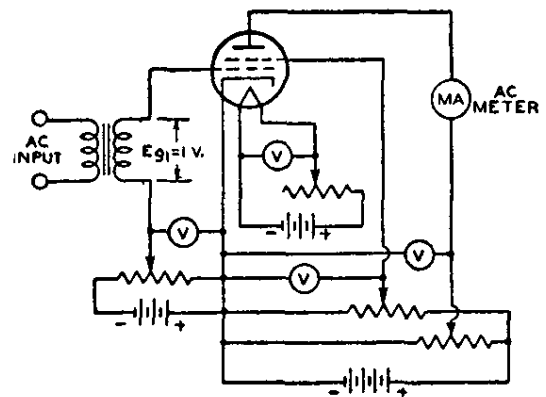

Fig. 77

under conditions which approximate actual operating conditions. The alternating component of the plate current is read by means of an ac ammeter of the dynamometer type. The transconductance of the tube is equal to the ac plate current divided by the input-signal voltage. If a one-volt RMS signal is applied to the grid, the plate-current-meter reading in milliamperes multiplied by one thousand is the value of transconductance in micromhos.

The **power-output test** probably gives the best correlation between test results and actual operating performance of a tube. In the case of voltage amplifiers, the power output is indicative of the amplification and output voltages obtainable from the tube. In the case of power-output tubes, the performance of the tube is closely checked. Consequently, although more complicated to set up, the power-output test will give closer correlation with actual performance than any other single test.

Fig. 78 shows the fundamental circuit of a power-output test for class A operation of tubes. The diagram illustrates the method for a pentode. The ac output voltage developed across the plate-load impedance (L) is indicated by the current meter. The current meter is isolated as far as the dc plate current is concerned by the capacitor (C). The power output can be calculated from the current reading and known load resistance. In this way, it is possible to determine the operating condition of the tube quite accurately.

Fig. 79 shows the fundamental circuit of a power-output test for class B operation of tubes. With ac voltage applied to the grid of the tube, the current in the plate circuit is read on a dc milliammeter. The power output of the tube is approximately equal to:

$$\text{Power output (watts)} = \frac{(\text{dc current in amperes})^2 \times \text{load resistance in ohms}}{0.405}$$

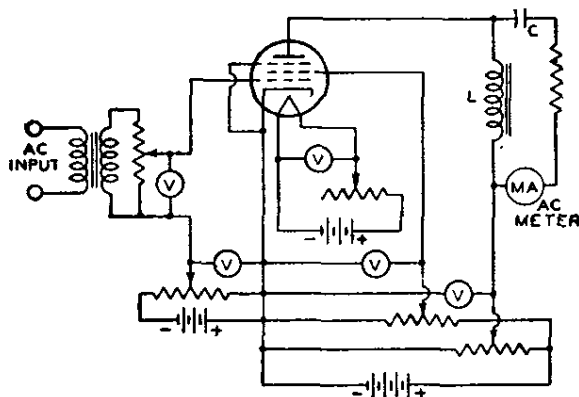

Fig. 78

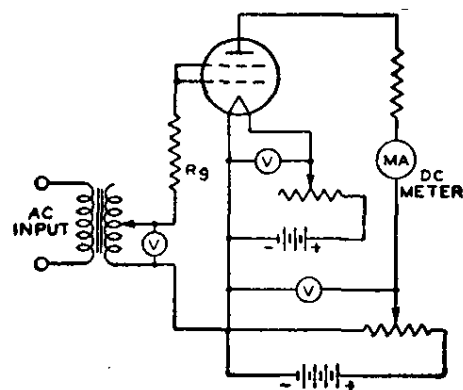

Fig. 79

ESSENTIAL TUBE-TESTER REQUIREMENTS

1. It is desirable that the tester provide for a short-circuit test to be made prior to measurement of the tube's characteristics.

2. It is important that some means of controlling the voltages applied to the electrodes of the tube be provided. If the tester is ac operated, a line-voltage control permits the supply of proper electrode voltages.

3. It is essential that the rated voltage applied to the filament or heater be maintained accurately.

4. It is suggested that the characteristics test follow one of the methods described. The method selected and the quality of the parts used in the test will depend upon the requirements of the user.

TUBE-TESTER LIMITATIONS

A tube-testing device can only indicate the difference between a given tube's characteristics and those which are standard for that particular type. Since the operating conditions imposed upon a tube of a given type may vary within wide limits, it is impossible for a tube-testing device to evaluate tubes in terms of performance capabilities for all applications. The tube tester, therefore, cannot be looked upon as a final authority in determining whether or not a tube is always satisfactory. Actual operating test in the equipment in which the tube is to be used will give the best possible indication of a tube's worth.

Resistance-Coupled Amplifiers

Type	Chart No.	Type	Chart No.
1L4	1	6SQ7(GT)	4
1S5	2	6SR7	9
1U4	3	6ST7	9
1U5	2	6SZ7	7
2A6	4	6T7-G	7
2B7	5	6W7-G	} T 11 } P 14
6A6	6		
6AQ6	7	6Z7-G	21
6AT6	7	12AT6	7
6AU6	8	12AU6	8
6B6-G	4	12AU7	10
6B7	5	12AX7	25
6B8(G)	5	12C8	5
6BF6	9	12F5-GT	18
6C4	10	12J5-GT	13
6C5(GT)	11	12J7-GT	} T 11 } P 14
6C6	11		
6C6	14	12Q7-GT	7
6C8-G	12	12SC7	17
6F5(GT)	18	12SF5	18
6F8-G	13	12SF7	19
6J5(GT)	13	12SH7	8
6J7(G,GT)	} T 11 } P 14	12SJ7(GT)	20
		12SL7-GT	7
6L5-G	15	12SN7-GT	13
6N7(GT)	6	12SQ7(GT)	4
6Q7(G,GT)	7	12SR7	9
6R7(GT)	9	53	6
6S7(G)	16	55	22
6SC7	17	56	23
6SF5(GT)	18	57	} T 11 } P 14
6SF7	19		
6SH7	8	75	4
6SJ7(GT)	20	76	23
6SL7-GT	7	79	24
6SN7-GT	13	85	22

T= Triode Connection
P= Pentode Connection

KEY TO CHARTS

Resistance-coupled, audio-frequency voltage amplifiers utilize simple components and are capable of providing essentially uniform amplification over a relatively wide frequency range.

Suitable Tubes

In this section, data are given for some 80 types of tubes suitable for use in resistance-coupled circuits. These types include low- and high-mu triodes, twin triodes, triode-connected pentodes, and pentodes. The accompanying key to tube types will assist in locating the appropriate data chart.

Circuit Advantages

For most of the types shown, the data pertain to operation with cathode bias; for all of the pentodes, the data pertain to operation with series screen resistor. The use of a cathode-bias resistor where feasible and a series screen resistor where applicable offer several advantages over fixed-voltage operation.

The advantages are: (1) effects of possible tube differences are minimized; (2) operation over a wide range of plate-supply voltages without appreciable change in gain is feasible; (3) the low frequency at which the amplifier cuts off is easily changed; and (4) tendency toward motorboating is minimized.

Number of Stages

These advantages can be enhanced by the addition of suitable decoupling filters in the plate supply of each stage of a multi-stage amplifier. With proper filters, three or more amplifier stages can be operated from a single power-supply unit of conventional design without encountering any difficulties due to coupling through the power unit. When decoupling filters are not used, not more than two stages should be operated from a single power-supply unit.

SYMBOLS USED IN RESISTANCE-COUPLED AMPLIFIER CHARTS

- | | |
|---|--|
| <p>C = Blocking Capacitor (μf).</p> <p>C_k = Cathode Bypass Capacitor (μf).</p> <p>C_{g2} = Screen Bypass Capacitor (μf).</p> <p>E_{bb} = Plate-Supply Voltage (volts).
Voltage at plate equals plate-supply voltage minus drop in R_p and R_k. See Note 1 below.</p> <p>R_k = Cathode Resistor (ohms).</p> <p>R_{g2} = Screen Resistor (megohms).</p> <p>R_g = Grid Resistor (megohms) for following stage.</p> <p>R_p = Plate Resistor (megohms).</p> | <p>V.G. = Voltage Gain. At 5 volts (RMS) output unless otherwise specified.</p> <p>E_o = Peak Output Voltage (volts).
This voltage is obtained across R_g (for following stage) at any frequency within the flat region of the output vs frequency curve, and is for the condition where the signal level is adequate to swing the grid of the resistance-coupled amplifier tube to the point where its grid starts to draw current.</p> |
|---|--|

Note 1: For other supply voltages differing by as much as 50 per cent from those listed, the values of resistors, capacitors, and voltage gain are approximately correct. The value of voltage output, however, for any of these other supply voltages, equals the listed voltage output multiplied by the new plate-supply voltage divided by the plate-supply voltage corresponding to the listed voltage output.

GENERAL CIRCUIT CONSIDERATIONS

In the discussions which follow, the frequency (f_2) is that value at which the high-frequency response begins to fall off. The frequency (f_1) is that value at which the low-frequency response drops below a satisfactory value, as discussed below. Decoupling filters are not necessary for two stages or less. A variation of 10 per cent in values of resistors and capacitors has only slight effect on performance. One-half-watt resistors are usually suitable for R_{g2}, R_g, R_p, and R_k resistors. Capacitors C and C_{g2} should have a working voltage equal to or greater than E_{bb}. Capacitor C_k may have a low working voltage in the order of 10 to 25 volts. Peak Input Voltage is equal to the Peak Output Voltage divided by the Voltage Gain.

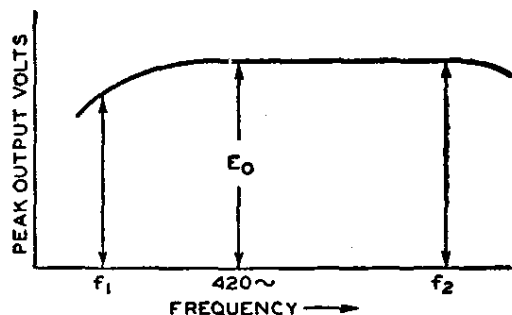

Triode (Heater-Cathode Type) Amplifier

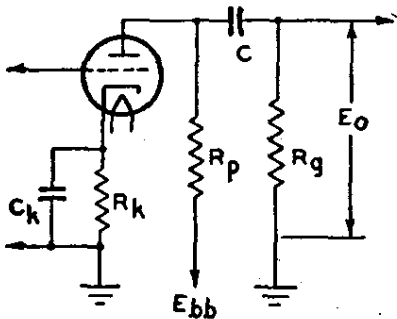

Diagram No. 1

Capacitors C and C_k have been chosen to give an output voltage equal to 0.8 E_o for a frequency (f_1) of 100 cycles. For any other value of f_1 , multiply values of C and C_k by 100/ f_1 . In the case of capacitor C_k, the values shown in the charts are for an amplifier with dc heater excitation; when ac is used, depending on the character of the associated circuit, the gain, and the value of f_1 , it may be necessary to increase the value of C_k to minimize hum disturbances. It may be desirable to operate the heater at a positive voltage of from 15 to 40 volts with respect to the cathode. The voltage output at f_1 of "n" like stages equals (0.8)ⁿE_o where

E_o is the peak output voltage of final stage. For an amplifier of typical construction, the value of f_2 is well above the audio-frequency range for any value of R_p.

Pentode (Filament-Type) Amplifier

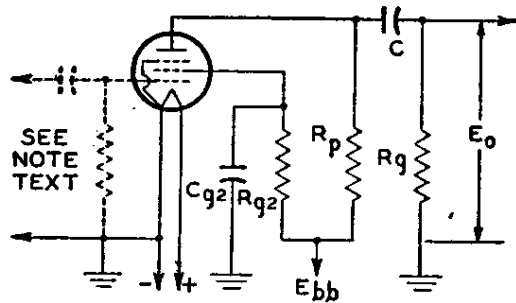

Diagram No. 2

should be such that their product lies between 0.02 and 0.1. Values commonly used are 0.005 μ f and 10 megohms.

Capacitors C and C_{g2} have been chosen to give an output voltage equal to 0.8 E_o for a frequency (f_1) of 100 cycles. For any other value of f_1 , multiply values of C and C_{g2} by $100/f_1$. The voltage output at f_1 for "n" like stages equals $(0.8)^n E_o$ where E_o is peak output voltage of final stage. For an amplifier of typical construction, and for R_p values of 0.1, 0.25, and 0.5 megohm, approximate values of f_2 are 20000, 10000, and 5000 cps, respectively. Note: The values of input-coupling capacitor in microfarads and of grid resistor in megohms

Pentode (Heater-Cathode Type) Amplifier

Capacitors C, C_k , and C_{g2} have been chosen to give an output voltage equal to 0.7 E_o for a frequency (f_1) of 100 cycles. For any other value of f_1 , multiply values of C, C_k , and C_{g2} by $100/f_1$. In the case of capacitor C_k , the values shown in the charts are for an amplifier with dc heater excitation; when ac is used, depending on the character of the associated circuits, the voltage gain, and the value of f_1 , it may be necessary to increase the value of C_k to minimize hum disturbances. It may be desirable to operate the heater at a positive voltage of from 15 to 40 volts with respect to the cathode. The voltage output at f_1 for "n" like stages equals $(0.7)^n E_o$ where E_o is peak output voltage of final stage. For an amplifier of typical construction, and for R_p values of 0.1, 0.25, and 0.5 megohm, approximate values of f_2 are 20000, 10000, and 5000 cps, respectively.

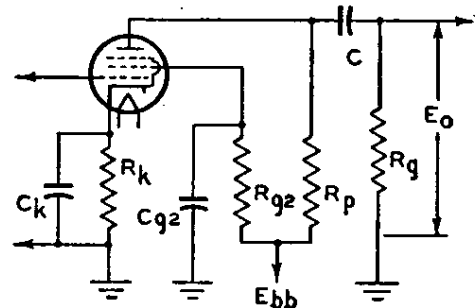

Diagram No. 3

For an amplifier of typical construction, and for R_p values of 0.1, 0.25, and 0.5 megohm, approximate values of f_2 are 20000, 10000, and 5000 cps, respectively.

Phase Inverters

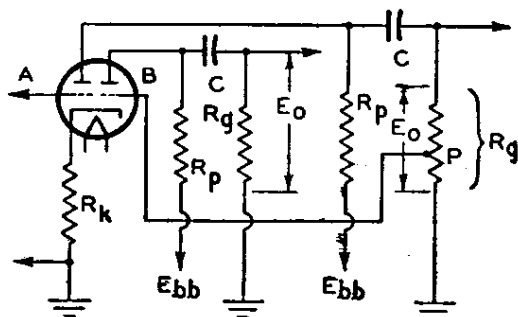

Diagram No. 4

values given in the charts. For example, if V.G. is 20 (from the charts), P is chosen so as to supply 1/20 of the voltage across R_g to the grid of unit B. For phase-inverter service, the cathode resistor may be left unbypassed unless a bypass capacitor is necessary to minimize hum; omission of the bypass capacitor assists in balancing the output stages. The value of R_k is specified on the basis that both units are operating simultaneously at the same values of plate load and plate voltage.

Information given for triode amplifiers, in general, applies to this case. Capacitors C have been chosen to give an output voltage equal to 0.9 E_o for a frequency (f_1) of 100 cycles. For any other value of f_1 , multiply values of C by $100/f_1$. The signal input is applied to grid of triode unit A. Grid of triode unit B obtains its signal from a tap (P) on the grid resistor (R_g) in the output circuit of unit A. The tap is chosen so as to make the voltage output of unit B equal to that of unit A. Its location is determined by the voltage gain

RCA RECEIVING TUBE MANUAL

(See page 195 for explanation of symbols)

Ebb	R _p	R _g	R _{g2}	R _k	C _{g2}	C _k	C	E _o	V.G.
45	0.22	0.22	0.24	—	0.071	—	0.011	12	16*
		0.47	0.32	—	0.06	—	0.006	14	23
		1.0	0.39	—	0.056	—	0.0035	18	30
	0.47	0.47	0.57	—	0.049	—	0.0052	14	22
		1.0	0.64	—	0.047	—	0.0035	17	30
		2.2	0.74	—	0.044	—	0.0018	19	33
	1.0	1.0	1.1	—	0.036	—	0.0028	14	28
		2.2	1.25	—	0.035	—	0.0018	16	32
		3.3	1.45	—	0.032	—	0.0015	18	38
90	0.22	0.22	0.4	—	0.089	—	0.011	26	28
		0.47	0.46	—	0.081	—	0.0055	36	36
		1.0	0.47	—	0.08	—	0.0035	42	41
	0.47	0.47	0.84	—	0.07	—	0.0055	30	34
		1.0	0.9	—	0.069	—	0.003	38	42
		2.2	1.0	—	0.062	—	0.0018	40	50
	1.0	1.0	2.0	—	0.045	—	0.0028	30	45
		2.2	2.1	—	0.045	—	0.0018	35	55
		3.3	2.2	—	0.044	—	0.0012	40	61
135	0.22	0.22	0.5	—	0.09	—	0.011	42	34
		0.47	0.63	—	0.074	—	0.0055	54	51
		1.0	0.67	—	0.072	—	0.0035	57	60
	0.47	0.47	1.1	—	0.071	—	0.005	47	49
		1.0	1.4	—	0.06	—	0.0028	54	68
		2.2	1.5	—	0.051	—	0.0018	60	87
	1.0	1.0	2.1	—	0.059	—	0.0025	45	53
		2.2	2.4	—	0.054	—	0.0018	57	88
		3.3	2.7	—	0.049	—	0.0012	61	91
45	0.22	0.22	0.26	—	0.042	—	0.013	14	17
		0.47	0.36	—	0.035	—	0.006	17	24
		1.0	0.4	—	0.034	—	0.004	18	28
	0.47	0.47	0.82	—	0.025	—	0.0055	14	25
		1.0	1.0	—	0.023	—	0.003	17	33
		2.2	1.1	—	0.022	—	0.002	18	38
	1.0	1.0	1.9	—	0.019	—	0.003	14	31
		2.2	2.0	—	0.019	—	0.002	17	38
		3.3	2.2	—	0.018	—	0.0015	18	43
90	0.22	0.22	0.5	—	0.05	—	0.011	31	25
		0.47	0.59	—	0.05	—	0.006	37	34
		1.0	0.67	—	0.042	—	0.003	40	41
	0.47	0.47	1.2	—	0.035	—	0.005	31	37
		1.0	1.4	—	0.034	—	0.003	36	47
		2.2	1.6	—	0.031	—	0.002	40	57
	1.0	1.0	2.5	—	0.026	—	0.003	31	45
		2.2	2.9	—	0.025	—	0.002	36	58
		3.3	3.1	—	0.024	—	0.0012	38	66
135	0.22	0.22	0.66	—	0.052	—	0.011	45	31
		0.47	0.71	—	0.051	—	0.006	56	41
		1.0	0.86	—	0.039	—	0.003	60	54
	0.47	0.47	1.45	—	0.042	—	0.005	46	44
		1.0	1.8	—	0.034	—	0.003	54	62
		2.2	1.9	—	0.033	—	0.002	60	71
	1.0	1.0	3.1	—	0.03	—	0.003	45	56
		2.2	3.7	—	0.029	—	0.0015	53	76
		3.3	4.3	—	0.026	—	0.0014	56	88

1

1L4

See Circuit
Diagram 2

2

1S5
1U5

See Circuit
Diagram 2

* At 4 volts (RMS) output.

RCA RECEIVING TUBE MANUAL

(See page 195 for explanation of symbols)

3

1U4

See Circuit Diagram 2

E _{bb}	R _p	R _g	R _{g2}	R _k	C _{g2}	C _k	C	E _o	V.G.
45	0.22	0.22	0.06	—	0.046	—	0.011	11	23
		0.47	0.07	—	0.045	—	0.006	15	33
		1.0	0.011	—	0.04	—	0.003	17	39
	0.47	0.47	0.34	—	0.025	—	0.005	13	34
		1.0	0.44	—	0.022	—	0.003	16	46
		2.2	0.5	—	0.022	—	0.002	18	55
	1.0	1.0	1.0	—	0.016	—	0.003	14	43
		2.2	1.0	—	0.016	—	0.002	17	51
		3.3	1.1	—	0.015	—	0.001	17	60
90	0.22	0.22	0.3	—	0.046	—	0.01	27	37
		0.47	0.36	—	0.04	—	0.006	36	54
		1.0	0.4	—	0.038	—	0.003	39	63
	0.47	0.47	0.9	—	0.027	—	0.0045	29	61
		1.0	1.0	—	0.023	—	0.003	35	82
		2.2	1.1	—	0.022	—	0.002	38	96
	1.0	1.0	1.9	—	0.02	—	0.0025	30	77
		2.2	2.0	—	0.02	—	0.002	35	98
		3.3	2.2	—	0.018	—	0.001	37	114
135	0.22	0.22	0.4	—	0.052	—	0.011	44	46
		0.47	0.49	—	0.037	—	0.005	55	71
		1.0	0.52	—	0.034	—	0.003	60	83
	0.47	0.47	1.1	—	0.029	—	0.0045	45	77
		1.0	1.3	—	0.023	—	0.003	53	106
		2.2	1.4	—	0.022	—	0.002	59	123
	1.0	1.0	2.3	—	0.021	—	0.0025	45	104
		2.2	2.5	—	0.019	—	0.0015	53	136
		3.3	2.9	—	0.016	—	0.001	56	163

4

2A6
6B6-G
6SQ7
6SQ7-GT
12SQ7
12SQ7-GT
75

See Circuit Diagram 1

90	0.1	0.1	—	6300	—	2.2	0.02	3	23 [◆]
		0.25	—	6600	—	1.7	0.01	5	29 [■]
		0.5	—	6700	—	1.7	0.006	6	31 [★]
	0.25	0.25	—	10000	—	1.24	0.01	5	34 [■]
		0.5	—	11000	—	1.07	0.006	7	40 [★]
		1.0	—	11500	—	0.9	0.003	10	40
	0.5	0.5	—	16200	—	0.75	0.005	7	39
		1.0	—	16600	—	0.7	0.003	10	44
		2.0	—	17400	—	0.65	0.0015	13	48
180	0.1	0.1	—	2600	—	3.3	0.025	16	29
		0.25	—	2900	—	2.9	0.015	22	36
		0.5	—	3000	—	2.7	0.007	23	37
	0.25	0.25	—	4300	—	2.1	0.015	21	43
		0.5	—	4800	—	1.8	0.007	28	50
		1.0	—	5300	—	1.5	0.004	33	53
	0.5	0.5	—	7000	—	1.3	0.007	25	52
		1.0	—	8000	—	1.1	0.004	33	57
		2.0	—	8800	—	0.9	0.002	38	58
300	0.1	0.1	—	1900	—	4.0	0.03	31	31
		0.25	—	2200	—	3.5	0.015	41	39
		0.5	—	2300	—	3.0	0.007	45	42
	0.25	0.25	—	3300	—	2.7	0.015	42	48
		0.5	—	3900	—	2.0	0.007	51	53
		1.0	—	4200	—	1.8	0.004	60	56
	0.5	0.5	—	5300	—	1.6	0.007	47	58
		1.0	—	6100	—	1.3	0.004	62	60
		2.0	—	7000	—	1.2	0.002	67	63

◆ At 2 volts (RMS) output. ■ At 3 volts (RMS) output. ★ At 4 volts (RMS) output

RCA RECEIVING TUBE MANUAL

(See page 195 for explanation of symbols)

E _{bb}	R _p	R _g	R _{g2}	R _k	C _{g2}	C _k	C	E _o	V.G.
90	0.1	0.1	0.37	2000	0.07	3.0	0.02	19	24
		0.25	0.5	2200	0.07	3.0	0.01	28	33
		0.5	0.6	2000	0.06	2.8	0.006	29	37
	0.25	0.25	1.18	3500	0.04	1.9	0.008	26	43
		0.5	1.1	3500	0.04	2.1	0.007	33	55
		1.0	1.35	3500	0.04	1.9	0.003	32	65
	0.5	0.5	2.6	5000	0.04	1.5	0.004	22	63
		1.0	2.8	6000	0.04	1.55	0.003	29	85
		2.0	2.9	6200	0.04	1.5	0.003	27	100
180	0.1	0.1	0.44	1000	0.08	4.4	0.02	30	30
		0.25	0.5	1200	0.08	4.4	0.015	52	41
		0.5	0.6	1200	0.07	4.0	0.008	53	46
	0.25	0.25	1.18	1900	0.05	2.7	0.01	39	55
		0.5	1.2	2100	0.06	3.2	0.007	55	69
		1.0	1.5	2200	0.05	3.0	0.003	53	83
	0.5	0.5	2.6	3300	0.04	2.1	0.005	47	81
		1.0	2.8	3500	0.04	2.0	0.003	55	115
		2.0	3.0	3500	0.04	2.2	0.002	53	116
300	0.1	0.1	0.5	950	0.09	4.6	0.025	60	36
		0.25	0.55	1100	0.09	5.0	0.015	89	47
		0.5	0.6	900	0.08	4.8	0.009	86	54
	0.25	0.25	1.2	1500	0.06	3.2	0.015	70	64
		0.5	1.2	1600	0.06	3.5	0.008	100	79
		1.0	1.5	1800	0.08	4.0	0.004	95	100
	0.5	0.5	2.7	2400	0.05	2.5	0.006	80	96
		1.0	2.9	2500	0.05	2.3	0.003	120	150
		2.0	3.4	2800	0.05	2.8	0.0025	90	145
90	0.1	0.1	-	1900*	-	-	0.025	13	16
		0.25	-	2250*	-	-	0.01	19	19
		0.5	-	2500*	-	-	0.006	20	20
	0.25	0.25	-	4050*	-	-	0.01	16	20
		0.5	-	4950*	-	-	0.006	20	22
		1.0	-	5400*	-	-	0.003	24	23
	0.5	0.5	-	7000*	-	-	0.006	18	22
		1.0	-	8500*	-	-	0.003	23	23
		2.0	-	9650*	-	-	0.0015	26	23
180	0.1	0.1	-	1300*	-	-	0.03	35	19
		0.25	-	1700*	-	-	0.015	46	21
		0.5	-	1950*	-	-	0.007	50	22
	0.25	0.25	-	2950*	-	-	0.015	40	23
		0.5	-	3800*	-	-	0.007	50	24
		1.0	-	4300*	-	-	0.0035	57	24
	0.5	0.5	-	5250*	-	-	0.007	44	24
		1.0	-	6600*	-	-	0.0035	54	25
		2.0	-	7650*	-	-	0.002	61	25
300	0.1	0.1	-	1150*	-	-	0.03	60	20
		0.25	-	1500*	-	-	0.015	83	22
		0.5	-	1750*	-	-	0.007	86	23
	0.25	0.25	-	2650*	-	-	0.015	75	23
		0.5	-	3400*	-	-	0.0055	87	24
		1.0	-	4000*	-	-	0.003	100	24
	0.5	0.5	-	4850*	-	-	0.0055	76	23
		1.0	-	6100*	-	-	0.003	94	24
		2.0	-	7150*	-	-	0.0015	104	24

5

2B7
6B7
6B8
6B8-G
12C8

See Circuit
Diagram 3

6

6A6 #
6N7 #
6N7-GT #
53 #

See Circuit
Diagram 4

The cathodes of the two units have a common terminal
*Values shown are for phase-inverter service.

RCA RECEIVING TUBE MANUAL

(See page 195 for explanation of symbols)

7

6AQ6
6AT6
6Q7
6Q7-G
6Q7-GT
6SL7-GT*
6SZ7
6T7-G
12AT6
12Q7-GT
12SL7-GT*

*(One Triode Unit # #)

See Circuit Diagram 1

E _{bb}	R _p	R _g	R _{g2}	R _k	C _{g2}	C _k	C	E _o	V.G.
90	0.1	0.1	-	4200	-	2.5	0.025	5.4	22 [●]
		0.22	-	4600	-	2.2	0.014	7.5	27 [●]
		0.47	-	4800	-	2.0	0.0065	9.1	30 [●]
	0.22	0.22	-	7000	-	1.5	0.013	7.3	30 [●]
		0.47	-	7800	-	1.3	0.007	10	34 [■]
		1.0	-	8100	-	1.1	0.0035	12	37 [★]
	0.47	0.47	-	12000	-	0.83	0.006	10	36 [■]
		1.0	-	14000	-	0.7	0.0035	14	39 [★]
		2.2	-	15000	-	0.6	0.002	16	41 [★]
180	0.1	0.1	-	1900	-	3.6	0.027	19	30 [★]
		0.22	-	2200	-	3.1	0.014	25	35
		0.47	-	2500	-	2.8	0.0065	32	37
	0.22	0.22	-	3400	-	2.2	0.014	24	38
		0.47	-	4100	-	1.7	0.0065	34	42
		1.0	-	4600	-	1.5	0.0035	38	44
	0.47	0.47	-	6600	-	1.1	0.0065	29	44
		1.0	-	8100	-	0.9	0.0035	38	46
		2.2	-	9100	-	0.8	0.002	43	47
300	0.1	0.1	-	1500	-	4.4	0.027	40	34
		0.22	-	1800	-	3.6	0.014	54	38
		0.47	-	2100	-	3.0	0.0065	63	41
	0.22	0.22	-	2600	-	2.5	0.013	51	42
		0.47	-	3200	-	1.9	0.0065	65	46
		1.0	-	3700	-	1.6	0.0035	77	48
	0.47	0.47	-	5200	-	1.2	0.006	61	48
		1.0	-	6300	-	1.0	0.0035	74	50
		2.2	-	7200	-	0.9	0.002	85	51

8

6AU6
6SH7
12AU6
12SH7

See Circuit Diagram 3

90	0.1	0.1	0.07	1800	0.11	9.0	0.021	25	52
		0.22	0.09	2100	0.1	8.2	0.012	32	72
		0.47	0.096	2100	0.1	8.0	0.0065	37	88
	0.22	0.22	0.25	3100	0.08	6.2	0.009	25	72
		0.47	0.26	3200	0.078	5.8	0.0055	32	99
		1.0	0.35	3700	0.085	5.1	0.003	34	125
	0.47	0.47	0.75	6300	0.042	3.4	0.0035	27	102
		1.0	0.75	6500	0.042	3.3	0.0027	32	126
		2.2	0.8	6700	0.04	3.2	0.0018	36	152
180	0.1	0.1	0.12	800	0.15	14.1	0.021	57	74
		0.22	0.15	900	0.126	14.0	0.012	82	116
		0.47	0.19	1000	0.1	12.5	0.006	81	141
	0.22	0.22	0.38	1500	0.09	9.6	0.009	59	130
		0.47	0.43	1700	0.08	8.7	0.005	67	171
		1.0	0.6	1900	0.066	8.1	0.003	71	200
	0.47	0.47	0.9	3100	0.06	5.7	0.0045	54	172
		1.0	1.0	3400	0.05	5.4	0.0028	65	232
		2.2	1.1	3600	0.04	3.6	0.0019	74	272
300	0.1	0.1	0.2	500	0.13	18.0	0.019	76	109
		0.22	0.24	600	0.11	16.4	0.011	103	145
		0.47	0.26	700	0.11	15.3	0.006	129	168
	0.22	0.22	0.42	1000	0.1	12.4	0.009	92	164
		0.47	0.5	1000	0.098	12.0	0.007	108	230
		1.0	0.55	1100	0.09	11.0	0.003	122	262
	0.47	0.47	1.0	1800	0.075	8.0	0.0045	94	248
		1.0	1.1	1900	0.065	7.6	0.0028	105	318
		2.2	1.2	2100	0.06	7.3	0.0018	122	371

● At 2 volts (RMS) output. ■ At 3 volts (RMS) output. ★ At 4 volts (RMS) output
 # # The cathodes of the two units have separate terminals.

RCA RECEIVING TUBE MANUAL

(See page 195 for explanation of symbols)

Ebb	R _p	R _g	R _{g2}	R _k	C _{g2}	C _k	C	E _o	V.G.
90	0.047	0.047	-	2200	-	2.5	0.063	14	9
		0.1	-	2800	-	2.0	0.033	18	10
		0.22	-	3200	-	1.7	0.015	20	10
	0.1	0.1	-	4100	-	1.4	0.032	13	10
		0.22	-	5400	-	1.0	0.013	20	11
		0.47	-	6400	-	0.9	0.007	24	11
	0.22	0.22	-	8500	-	0.67	0.015	18	11
		0.47	-	12000	-	0.5	0.0065	23	11
		1.0	-	14000	-	0.43	0.0035	27	11
180	0.047	0.047	-	2000	-	2.9	0.062	32	10
		0.1	-	2500	-	2.2	0.033	42	10
		0.22	-	3000	-	1.9	0.016	47	11
	0.1	0.1	-	3800	-	1.5	0.033	36	11
		0.22	-	5100	-	1.1	0.015	47	11
		0.47	-	6200	-	0.9	0.007	55	12
	0.22	0.22	-	8000	-	0.73	0.015	41	12
		0.47	-	11000	-	0.5	0.007	54	12
		1.0	-	13000	-	0.4	0.0035	69	12
300	0.047	0.047	-	1800	-	3.0	0.063	58	10
		0.1	-	2400	-	2.4	0.033	74	11
		0.22	-	2900	-	2.0	0.016	85	11
	0.1	0.1	-	3600	-	1.6	0.033	65	12
		0.22	-	5000	-	1.2	0.015	85	12
		0.47	-	6200	-	0.95	0.007	96	12
	0.22	0.22	-	7800	-	0.73	0.015	74	12
		0.47	-	11000	-	0.5	0.007	95	12
		1.0	-	13000	-	0.43	0.0035	106	12
90	0.047	0.047	-	1600	-	3.2	0.061	9	10 [■]
		0.1	-	1800	-	2.5	0.033	11	11 [★]
		0.22	-	2000	-	2.0	0.015	14	11
	0.1	0.1	-	3000	-	1.6	0.032	10	11 [★]
		0.22	-	3800	-	1.1	0.015	15	11
		0.47	-	4500	-	1.0	0.007	18	11
	0.22	0.22	-	6800	-	0.7	0.015	14	11
		0.47	-	9500	-	0.5	0.0065	20	11
		1.0	-	11500	-	0.43	0.0035	24	11
180	0.047	0.047	-	920	-	3.9	0.062	20	11
		0.1	-	1200	-	2.9	0.037	26	12
		0.22	-	1400	-	2.5	0.016	29	12
	0.1	0.1	-	2000	-	1.9	0.032	24	12
		0.22	-	2800	-	1.4	0.016	33	12
		0.47	-	3600	-	1.1	0.007	40	12
	0.22	0.22	-	5300	-	0.8	0.015	31	12
		0.47	-	8300	-	0.56	0.007	44	12
		1.0	-	10000	-	0.48	0.0035	54	12
300	0.047	0.047	-	870	-	4.1	0.065	38	12
		0.1	-	1200	-	3.0	0.034	52	12
		0.22	-	1500	-	2.4	0.016	68	12
	0.1	0.1	-	1900	-	1.9	0.032	44	12
		0.22	-	3000	-	1.3	0.016	68	12
		0.47	-	4000	-	1.1	0.007	80	12
	0.22	0.22	-	5300	-	0.9	0.015	57	12
		0.47	-	8800	-	0.52	0.007	82	12
		1.0	-	11000	-	0.46	0.0035	92	12

9

**6BF6
6R7
6R7-GT
6SR7
6ST7
12SR7**

See Circuit
Diagram 1

10

**6C4
12AU7^{*}**
(One Triode
Unit # #)

See Circuit
Diagram 1

■ At 3 volts (RMS) output. ★ At 4 volts (RMS) output.
The cathodes of the two units have separate terminals.

RCA RECEIVING TUBE MANUAL

(See page 195 for explanation of symbols)

11

6C5
6C5-GT
6C6*
6J7*
6J7-G*
6J7-GT*
6W7-G*
12J7-GT*
57*
 *As Triode

See Circuit Diagram 1

E _{bb}	R _p	R _g	R _{g2}	R _k	C _{g2}	C _k	C	E _o	V.G.
90	0.05	0.05	-	2800	-	2.0	0.05	14	9
		0.1	-	3400	-	1.62	0.025	17	9
		0.25	-	3800	-	1.3	0.01	20	10
	0.1	0.1	-	4800	-	1.12	0.025	16	10
		0.25	-	6400	-	0.84	0.01	22	11
		0.5	-	7500	-	0.66	0.005	23	12
0.25	0.25	-	11400	-	0.52	0.01	18	12	
	0.5	-	14500	-	0.4	0.006	23	12	
	1.0	-	17300	-	0.33	0.004	26	13	
180	0.05	0.05	-	2200	-	2.2	0.055	34	10
		0.1	-	2700	-	2.1	0.03	45	11
		0.25	-	3100	-	1.85	0.015	54	11
	0.1	0.1	-	3900	-	1.7	0.035	41	12
		0.25	-	5300	-	1.25	0.015	54	12
		0.5	-	6200	-	1.2	0.008	55	13
	0.25	0.25	-	9500	-	0.74	0.015	44	13
		0.5	-	12300	-	0.55	0.008	52	13
		1.0	-	14700	-	0.47	0.004	59	13
300	0.05	0.05	-	2100	-	3.16	0.075	57	11
		0.1	-	2600	-	2.3	0.04	70	11
		0.25	-	3100	-	2.2	0.015	83	12
	0.1	0.1	-	3800	-	1.7	0.035	65	12
		0.25	-	5300	-	1.3	0.015	84	13
		0.5	-	6000	-	1.17	0.008	88	13
	0.25	0.25	-	9600	-	0.9	0.015	73	13
		0.5	-	12300	-	0.59	0.008	85	14
		1.0	-	14000	-	0.37	0.003	97	14

12

6C8-G
 (One Triode Unit # #)

See Circuit Diagram 1

90	0.1	0.1	-	3040	-	2.34	0.028	13	18
		0.25	-	3700	-	1.48	0.0115	17	20
		0.5	-	4520	-	1.29	0.006	19	21
	0.25	0.25	-	6770	-	0.95	0.011	15	21
		0.5	-	7870	-	0.81	0.0065	19	23
		1.0	-	8830	-	0.69	0.0035	21	23
180	0.5	0.5	-	12400	-	0.51	0.006	16	22
		1.0	-	15000	-	0.43	0.0035	20	24
		2.0	-	16500	-	0.38	0.0015	25	24
	0.1	0.1	-	2420	-	2.34	0.028	30	20
		0.25	-	3080	-	1.84	0.012	40	22
		0.5	-	3560	-	1.6	0.0065	45	23
0.25	0.25	-	5170	-	1.25	0.012	35	24	
	0.5	-	6560	-	0.95	0.007	45	25	
	1.0	-	7550	-	0.85	0.0035	50	26	
300	0.5	0.5	-	9840	-	0.66	0.007	38	25
		1.0	-	12500	-	0.5	0.004	44	26
		2.0	-	15600	-	0.44	0.0015	51	26
	0.1	0.1	-	2120	-	3.93	0.037	55	22
		0.25	-	2840	-	2.01	0.013	73	23
		0.5	-	3250	-	1.79	0.007	80	25
0.25	0.25	-	4750	-	1.29	0.013	64	25	
	0.5	-	6100	-	0.96	0.0065	80	26	
	1.0	-	7100	-	0.77	0.004	90	27	
0.5	0.5	-	9000	-	0.67	0.007	67	27	
	1.0	-	11500	-	0.48	0.004	83	27	
	2.0	-	14500	-	0.37	0.002	96	28	

The cathodes of the two units have separate terminals.

RCA RECEIVING TUBE MANUAL

(See page 195 for explanation of symbols)

Ebb	R _p	R _g	R _{g2}	R _k	C _{g2}	C _k	C	E _o	V.G.
90	0.05	0.05	-	1650	-	2.80	0.06	11	11
		0.1	-	2070	-	2.66	0.029	14	12
		0.25	-	2380	-	1.95	0.012	17	13
	0.1	0.1	-	3470	-	1.85	0.035	12	13
		0.25	-	3940	-	1.29	0.012	17	13
		0.5	-	4420	-	1.0	0.007	19	13
	0.25	0.25	-	7860	-	0.73	0.0135	14	13
		0.5	-	9760	-	0.55	0.007	18	13
		1.0	-	10690	-	0.47	0.004	20	13
180	0.05	0.05	-	1190	-	3.27	0.06	24	13
		0.1	-	1490	-	2.86	0.032	30	13
		0.25	-	1740	-	2.06	0.0115	36	13
	0.1	0.1	-	2330	-	2.19	0.038	26	14
		0.25	-	2830	-	1.35	0.012	34	14
		0.5	-	3230	-	1.15	0.006	38	14
	0.25	0.25	-	5560	-	0.81	0.013	28	14
		0.5	-	7000	-	0.62	0.007	36	14
		1.0	-	8110	-	0.5	0.004	40	14
300	0.05	0.05	-	1020	-	3.56	0.06	41	13
		0.1	-	1270	-	2.96	0.034	51	14
		0.25	-	1500	-	2.15	0.012	60	14
	0.1	0.1	-	1900	-	2.31	0.035	43	14
		0.25	-	2440	-	1.42	0.0125	56	14
		0.5	-	2700	-	1.2	0.0065	64	14
	0.25	0.25	-	4590	-	0.87	0.013	46	14
		0.5	-	5770	-	0.64	0.0075	57	14
		1.0	-	6950	-	0.54	0.004	64	14

13

6F8-G*
6J5
6J5-GT
6SN7-GT*
12J5-GT
12SN7-GT*
 (One Triode Unit # #)

See Circuit Diagram 1

90	0.1	0.1	0.37	1200	0.05	5.2	0.02	17	41
		0.25	0.44	1100	0.05	5.3	0.01	22	55
		0.5	0.44	1300	0.05	4.8	0.006	33	66
	0.25	0.25	1.1	2400	0.03	3.7	0.008	23	70
		0.5	1.18	2600	0.03	3.2	0.005	32	85
		1.0	1.4	3600	0.025	2.5	0.003	33	92
	0.5	0.5	2.18	4700	0.02	2.3	0.005	28	93
		1.0	2.6	5500	0.05	2.0	0.0025	29	120
		2.0	2.7	5500	0.02	2.0	0.0015	27	140
180	0.1	0.1	0.44	1000	0.05	6.5	0.02	42	51
		0.25	0.5	750	0.05	6.7	0.01	52	69
		0.5	0.5	800	0.05	6.7	0.006	59	83
	0.25	0.25	1.1	1200	0.04	5.2	0.008	41	93
		0.5	1.18	1600	0.04	4.3	0.005	60	118
		1.0	1.4	2000	0.04	3.8	0.0035	60	140
	0.5	0.5	2.45	2600	0.03	3.2	0.005	45	135
		1.0	2.9	3100	0.025	2.5	0.0025	56	165
		2.0	2.7	3500	0.02	2.8	0.0015	60	165
300	0.1	0.1	0.44	500	0.07	8.5	0.02	55	61
		0.25	0.5	450	0.07	8.3	0.01	81	82
		0.5	0.53	600	0.06	8.0	0.006	96	94
	0.25	0.25	1.18	1100	0.04	5.5	0.008	81	104
		0.5	1.18	1200	0.04	5.4	0.005	104	140
		1.0	1.45	1300	0.05	5.8	0.005	110	185
	0.5	0.5	2.45	1700	0.04	4.2	0.005	75	161
		1.0	2.9	2200	0.04	4.1	0.003	97	200
		2.0	2.95	2300	0.04	4.0	0.0025	100	230

14

As Pentodes
6C6
6J7
6J7-G
6J7-GT
6W7-G
12J7-GT
57

See Circuit Diagram 3

The cathodes of the two units have separate terminals.

RCA RECEIVING TUBE MANUAL

(See page 195 for explanation of symbols)

15

6L5-G

See Circuit Diagram 1

E _{bb}	R _p	R _g	R _{g2}	R _k	C _{g2}	C _k	C	E _o	V.G.*
90	0.05	0.05	—	2120	—	2.3	0.05	14	9.3
		0.1	—	2500	—	1.86	0.03	18	10
		0.25	—	2900	—	1.65	0.014	21	11
	0.1	0.1	—	3510	—	1.36	0.03	16	11
		0.25	—	4620	—	1.08	0.015	22	12
		0.5	—	5200	—	1.0	0.0085	23	12
	0.25	0.25	—	8050	—	0.61	0.0125	18	12
		0.5	—	10300	—	0.49	0.0085	22	12
		1.0	—	12100	—	0.42	0.0055	24	12
180	0.05	0.05	—	1810	—	2.9	0.06	32	10
		0.1	—	2240	—	2.2	0.03	41	11
		0.25	—	2660	—	1.8	0.014	46	12
	0.1	0.1	—	3180	—	1.46	0.03	36	12
		0.25	—	4200	—	1.1	0.0145	46	12
		0.5	—	4790	—	1.0	0.009	50	12
	0.25	0.25	—	7100	—	0.7	0.014	38	12
		0.5	—	9290	—	0.54	0.009	46	12
		1.0	—	10950	—	0.46	0.0055	52	13
300	0.05	0.05	—	1740	—	2.91	0.06	56	11
		0.1	—	2160	—	2.18	0.032	68	12
		0.25	—	2600	—	1.82	0.015	79	12
	0.1	0.1	—	3070	—	1.64	0.032	60	12
		0.25	—	4140	—	1.1	0.014	79	13
		0.5	—	4700	—	0.81	0.0075	89	13
	0.25	0.25	—	6900	—	0.57	0.013	64	13
		0.5	—	9100	—	0.46	0.0075	80	13
		1.0	—	10750	—	0.4	0.005	88	13

16

**6S7
6S7-G**

See Circuit Diagram 3

90	0.1	0.1	0.59	870	0.065	5.1	0.018	16	33
		0.25	0.65	900	0.061	5.0	0.01	21	47
		0.5	0.7	910	0.057	4.58	0.007	23	54
	0.25	0.25	1.5	1440	0.044	3.38	0.007	14	56
		0.5	1.6	1520	0.044	3.23	0.0055	18	66
		1.0	1.7	1560	0.043	3.22	0.004	19	77
	0.5	0.5	3.2	2620	0.029	2.04	0.004	12	70
		1.0	3.5	2800	0.03	1.95	0.0026	15	84
		2.0	3.7	3000	0.031	1.92	0.0024	16	94
180	0.1	0.1	0.58	530	0.073	7.2	0.017	33	47
		0.25	0.68	540	0.07	6.9	0.01	43	66
		0.5	0.71	540	0.065	6.6	0.0063	48	75
	0.25	0.25	1.6	850	0.05	4.6	0.0071	33	79
		0.5	1.8	890	0.044	4.7	0.005	40	104
		1.0	1.9	950	0.046	4.4	0.0037	44	118
	0.5	0.5	3.3	1410	0.041	3.5	0.0041	30	109
		1.0	3.6	1520	0.037	3.0	0.003	38	134
		2.0	3.8	1600	0.031	2.9	0.0024	42	147
300	0.1	0.1	0.59	430	0.007	8.5	0.0167	57	57
		0.25	0.67	440	0.071	8.0	0.01	75	78
		0.5	0.71	440	0.071	8.0	0.0066	82	89
	0.25	0.25	1.7	620	0.058	6.0	0.0071	54	98
		0.5	1.95	650	0.057	5.8	0.005	66	122
		1.0	2.1	700	0.055	5.2	0.0036	76	136
	0.5	0.5	3.6	1000	0.04	4.1	0.0037	52	136
		1.0	3.9	1080	0.041	3.9	0.0029	66	162
		2.0	4.1	1120	0.043	3.8	0.0023	73	174

★ At 4 volts (RMS) output.

RCA RECEIVING TUBE MANUAL

(See page 195 for explanation of symbols)

E _{bb}	R _p	R _g	R _{g2}	R _k	C _{g2}	C _k	C	E _o	V.G.
90	0.1	0.1	-	1850*	-	-	0.028	4.1	13 [●]
		0.25	-	1960*	-	-	0.012	5.9	23 [■]
		0.5	-	2050*	-	-	0.0065	6.9	25 [★]
	0.25	0.25	-	3400*	-	-	0.011	6.2	26 [★]
		0.5	-	3750*	-	-	0.006	8.6	30
		1.0	-	3900*	-	-	0.003	10	33
	0.5	0.5	-	5500*	-	-	0.005	7.4	31
		1.0	-	6300*	-	-	0.003	10	33
		2.0	-	7450*	-	-	0.0015	12	36
180	0.1	0.1	-	960*	-	-	0.031	17	25
		0.25	-	1070*	-	-	0.012	24	29
		0.5	-	1220*	-	-	0.0065	27	33
	0.25	0.25	-	1850*	-	-	0.011	21	35
		0.5	-	2150*	-	-	0.006	28	39
		1.0	-	2400*	-	-	0.003	32	41
	0.5	0.5	-	3050*	-	-	0.006	24	40
		1.0	-	3420*	-	-	0.003	32	43
		2.0	-	3890*	-	-	0.002	36	45
300	0.1	0.1	-	750*	-	-	0.033	35	29
		0.25	-	930*	-	-	0.014	50	34
		0.25	-	1040*	-	-	0.007	54	36
	0.25	0.25	-	1400*	-	-	0.012	45	39
		0.5	-	1680*	-	-	0.006	55	42
		1.0	-	1840*	-	-	0.003	64	45
	0.5	0.5	-	2330*	-	-	0.006	50	45
		1.0	-	2980*	-	-	0.003	62	48
		2.0	-	3280*	-	-	0.002	72	49
90	0.1	0.1	-	4400	-	2.5	0.02	4	28 [●]
		0.25	-	4800	-	2.1	0.01	5	34 [■]
		0.5	-	5000	-	1.8	0.005	6	35 [★]
	0.25	0.25	-	8000	-	1.33	0.01	6	39 [■]
		0.5	-	8800	-	1.18	0.005	7	43 [★]
		1.0	-	9000	-	0.9	0.003	10	44
	0.5	0.5	-	12200	-	0.76	0.005	8	43
		1.0	-	13500	-	0.67	0.003	10	46
		2.0	-	14700	-	0.58	0.0015	12	48
180	0.1	0.1	-	1800	-	4.4	0.025	16	37
		0.25	-	2000	-	3.3	0.015	23	44
		0.5	-	2200	-	2.9	0.006	25	46
	0.25	0.25	-	3500	-	2.3	0.01	21	48
		0.5	-	4100	-	1.8	0.006	26	53
		1.0	-	4500	-	1.7	0.004	32	57
	0.5	0.5	-	6100	-	1.3	0.006	24	53
		1.0	-	6900	-	0.9	0.003	33	63
		2.0	-	7700	-	0.83	0.0015	37	66
300	0.1	0.1	-	1300	-	5.0	0.025	33	42
		0.25	-	1600	-	3.7	0.01	43	49
		0.5	-	1700	-	3.2	0.006	48	52
	0.25	0.25	-	2600	-	2.5	0.01	41	56
		0.5	-	3200	-	2.1	0.007	54	63
		1.0	-	3500	-	2.0	0.004	63	67
	0.5	0.5	-	4500	-	1.5	0.006	50	65
		1.0	-	5400	-	1.2	0.004	62	70
		2.0	-	6100	-	0.93	0.002	70	70

17

6SC7 #
12SC7 #

See Circuit
Diagram 4

18

6F5
6F5-GT
6SF5
6SF5-GT
12F5-GT
12SF5

See Circuit
Diagram 1

● At 2 volts (RMS) output. ■ At 3 volts (RMS) output. ★ At 4 volts (RMS) output.
The cathodes of the two units have a common terminal.
* Values are for phase-inverter service.

RCA RECEIVING TUBE MANUAL

(See page 195 for explanation of symbols)

19

**6SF7
12SF7**

See Circuit Diagram 3

E _{bb}	R _p	R _g	R _{g2}	R _k	C _{g2}	C _k	C	E _o	V.G.
90	0.1	0.1	0.26	1500	0.11	4.8	0.02	21	21
		0.22	0.3	1600	0.1	4.4	0.012	26	29
		0.47	0.35	1900	0.09	4.2	0.006	28	37
	0.22	0.22	0.64	2400	0.09	3.4	0.009	21	33
		0.47	0.7	2500	0.09	3.2	0.0055	26	40
		1.0	0.84	2600	0.084	3.0	0.0035	29	52
	0.47	0.47	1.5	4200	0.06	2.1	0.0045	21	50
		1.0	1.6	4400	0.06	1.9	0.003	26	59
		2.2	1.7	4800	0.058	1.6	0.002	29	64
180	0.1	0.1	0.33	1000	0.13	6.7	0.02	32	33
		0.22	0.5	1200	0.12	5.8	0.011	37	45
		0.47	0.6	1300	0.11	5.5	0.006	43	52
	0.22	0.22	0.76	1700	0.11	4.5	0.0095	37	47
		0.47	0.9	1700	0.1	4.5	0.0055	44	68
		1.0	1.0	1800	0.1	4.2	0.003	47	82
	0.47	0.47	1.8	3300	0.09	2.9	0.0045	38	70
		1.0	2.0	3800	0.08	2.4	0.003	50	85
		2.2	2.1	4000	0.07	2.3	0.002	57	98
300	0.1	0.1	0.32	750	0.19	8.0	0.021	62	39
		0.22	0.36	850	0.18	7.7	0.012	80	46
		0.47	0.37	900	0.18	7.7	0.006	93	57
	0.22	0.22	0.8	1150	0.13	6	0.01	63	62
		0.47	0.94	1300	0.12	5.7	0.0055	78	88
		1.0	0.98	1500	0.11	5.0	0.0035	99	97
	0.47	0.47	1.7	2300	0.1	3.5	0.0045	71	82
		1.0	1.9	2500	0.1	3.5	0.003	89	109
		2.2	2.0	2800	0.09	3.1	0.002	105	125

20

**6SJ7
6SJ7-GT
12SJ7
12SJ7-GT**

See Circuit Diagram 3

90	0.1	0.1	0.29	820	0.09	8.8	0.02	18	41
		0.25	0.29	880	0.085	7.4	0.016	23	68
		0.5	0.31	1000	0.075	6.6	0.007	28	70
	0.25	0.25	0.69	1680	0.06	5.0	0.012	16	75
		0.5	0.92	1700	0.045	4.5	0.005	18	93
		1.0	0.82	1800	0.04	4.0	0.003	22	104
	0.5	0.5	1.5	3600	0.045	2.4	0.003	18	91
		1.0	1.7	3800	0.03	2.4	0.002	22	119
		2.0	1.9	4050	0.028	2.35	0.0015	24	139
180	0.1	0.1	0.29	760	0.10	9.1	0.019	49	55
		0.25	0.31	800	0.09	8.0	0.015	60	82
		0.5	0.37	860	0.09	7.8	0.007	62	91
	0.25	0.25	0.83	1050	0.06	6.8	0.001	38	109
		0.5	0.94	1060	0.06	6.6	0.004	47	131
		1.0	0.94	1100	0.07	6.1	0.003	54	161
	0.5	0.5	1.85	2000	0.05	4.0	0.003	37	151
		1.0	2.2	2180	0.04	3.8	0.002	44	192
		2.0	2.4	2410	0.035	3.6	0.0015	54	208
300	0.1	0.1	0.35	500	0.10	11.6	0.019	72	67
		0.25	0.37	530	0.09	10.9	0.016	96	98
		0.5	0.47	590	0.09	9.9	0.007	101	104
	0.25	0.25	0.89	850	0.07	8.5	0.011	79	139
		0.5	1.10	860	0.06	7.4	0.004	88	167
		1.0	1.18	910	0.06	6.9	0.003	98	185
	0.5	0.5	2.0	1300	0.06	6.0	0.004	64	200
		1.0	2.2	1410	0.05	5.8	0.002	79	238
		2.0	2.5	1530	0.04	5.2	0.0015	89	263

RCA RECEIVING TUBE MANUAL

(See page 195 for explanation of symbols)

E _{bb}	R _p	R _g	R _{g2}	R _k	C _{g2}	C _k	C	E _o	V.G.
90	0.1	0.1	—	1480*	—	2.65	0.025	8	21*
		0.25	—	1760*	—	2.02	0.0115	11	25
		0.5	—	1930*	—	1.7	0.0065	14	26
	0.25	0.25	—	3000*	—	1.36	0.01	12	28
		0.5	—	3390*	—	1.1	0.006	15	30
		1.0	—	3670*	—	0.8	0.0035	18	33
	0.5	0.5	—	5300*	—	0.65	0.0055	14	31
		1.0	—	6050*	—	0.61	0.003	18	33
		2.0	—	6700*	—	0.45	0.0015	20	35
180	0.1	0.1	—	930*	—	3.4	0.028	18	26
		0.25	—	1100*	—	2.6	0.0115	28	31
		0.5	—	1210*	—	2.32	0.007	33	32
	0.25	0.25	—	1820*	—	1.71	0.012	28	35
		0.5	—	2110*	—	1.38	0.007	34	38
		1.0	—	2400*	—	1.1	0.0035	41	39
	0.5	0.5	—	3240*	—	0.9	0.006	32	39
		1.0	—	3890*	—	0.703	0.0035	38	40
		2.0	—	4360*	—	0.553	0.002	44	41
300	0.1	0.1	—	670*	—	3.81	0.028	38	31
		0.25	—	950*	—	2.63	0.012	52	34
		0.5	—	1050*	—	2.34	0.007	60	36
	0.25	0.25	—	1430*	—	1.87	0.012	50	38
		0.5	—	1680*	—	1.46	0.006	59	40
		1.0	—	1930*	—	1.19	0.0035	66	43
	0.5	0.5	—	2540*	—	0.97	0.006	55	42
		1.0	—	3110*	—	0.72	0.0035	70	44
		2.0	—	3560*	—	0.56	0.002	75	45
90	0.05	0.05	—	3800	—	1.4	0.06	16	4.5
		0.1	—	4600	—	1.1	0.03	19	4.9
		0.25	—	5400	—	0.86	0.015	23	5.1
	0.1	0.1	—	6620	—	0.7	0.04	17	5.1
		0.25	—	9000	—	0.55	0.015	22	5.4
		0.5	—	10300	—	0.5	0.007	25	5.5
	0.25	0.25	—	15100	—	0.31	0.015	18	5.3
		0.5	—	20500	—	0.25	0.007	23	5.5
		1.0	—	24400	—	0.2	0.004	26	5.6
180	0.05	0.05	—	3200	—	1.8	0.06	33	4.9
		0.1	—	4100	—	1.6	0.045	44	5.2
		0.25	—	5000	—	1.2	0.02	49	5.3
	0.1	0.1	—	6200	—	0.9	0.04	37	5.3
		0.25	—	8700	—	0.7	0.015	47	5.5
		0.5	—	10000	—	0.57	0.008	50	5.5
	0.25	0.25	—	14500	—	0.43	0.015	40	5.6
		0.5	—	20000	—	0.29	0.008	48	5.7
		1.0	—	24000	—	0.24	0.004	53	5.7
300	0.05	0.05	—	3200	—	1.9	0.08	50	5.2
		0.1	—	4100	—	1.5	0.045	74	5.5
		0.25	—	5100	—	1.2	0.015	85	5.6
	0.1	0.1	—	5900	—	0.8	0.03	64	5.5
		0.25	—	8300	—	0.54	0.015	82	5.7
		0.5	—	9600	—	0.43	0.006	88	5.8
	0.25	0.25	—	14300	—	0.3	0.01	71	5.7
		0.5	—	19400	—	0.22	0.006	84	5.7
		1.0	—	23600	—	0.2	0.003	94	5.8

21

6Z7-G#

See Circuit Diagram 4

22

**55
85**

See Circuit Diagram 1

★ At 4 volts (RMS) output. *Values are for phase-inverter service.
#The cathodes of the two units have a common terminal.

RCA RECEIVING TUBE MANUAL

(See page 195 for explanation of symbols)

23

56
76

See Circuit
Diagram 1

E _{bb}	R _p	R _g	R _{g2}	R _k	C _{g2}	C _k	C	E _o	V.G.
90	0.05	0.05	—	2500	—	2.0	0.06	16	7.0
		0.1	—	3200	—	1.6	0.03	21	7.7
		0.25	—	3800	—	1.25	0.015	23	8.1
	0.1	0.1	—	4500	—	1.05	0.03	19	8.1
		0.25	—	6500	—	0.82	0.015	23	8.9
		0.5	—	7500	—	0.68	0.007	25	9.3
	0.25	0.25	—	11100	—	0.48	0.015	21	9.4
		0.5	—	15100	—	0.36	0.007	24	9.7
		1.0	—	18300	—	0.32	0.0035	28	9.8
180	0.05	0.05	—	2400	—	2.5	0.06	36	7.7
		0.1	—	3000	—	1.9	0.035	48	8.2
		0.25	—	3700	—	1.65	0.015	55	9.0
	0.1	0.1	—	4500	—	1.45	0.035	45	9.3
		0.25	—	6500	—	0.97	0.015	55	9.5
		0.5	—	7600	—	0.8	0.008	57	9.8
	0.25	0.25	—	10700	—	0.6	0.015	49	9.7
		0.5	—	14700	—	0.45	0.007	59	10
		1.0	—	17700	—	0.4	0.0045	64	10
300	0.05	0.05	—	2400	—	2.8	0.08	65	8.3
		0.1	—	3100	—	2.2	0.045	80	8.9
		0.25	—	3800	—	1.8	0.02	95	9.4
	0.1	0.1	—	4500	—	1.6	0.04	74	9.5
		0.25	—	6400	—	1.2	0.02	95	10
		0.5	—	7500	—	0.98	0.009	104	10
	0.25	0.25	—	11100	—	0.69	0.02	82	10
		0.5	—	15200	—	0.5	0.009	96	10
		1.0	—	18300	—	0.4	0.005	108	10

24

79#

See Circuit
Diagram 4

90	0.1	0.1	—	2050*	—	—	0.04	5.8	23■
		0.25	—	2200*	—	—	0.015	8.4	29★
		0.5	—	2350*	—	—	0.009	9.5	29
	0.25	0.25	—	4000*	—	—	0.015	7.1	31★
		0.5	—	4250*	—	—	0.006	9.7	33
		1.0	—	4650*	—	—	0.004	12	35
	0.5	0.5	—	6150*	—	—	0.006	8.8	34
		1.0	—	6850*	—	—	0.004	12	38
		2.0	—	7500*	—	—	0.002	15	40
180	0.1	0.1	—	1050*	—	—	0.04	21	27
		0.25	—	1250*	—	—	0.02	27	31
		0.5	—	1350*	—	—	0.009	31	34
	0.25	0.25	—	2050*	—	—	0.02	26	37
		0.5	—	2450*	—	—	0.01	34	41
		1.0	—	2750*	—	—	0.005	40	42
	0.5	0.5	—	3450*	—	—	0.009	30	42
		1.0	—	4100*	—	—	0.0035	39	44
		2.0	—	4650*	—	—	0.002	44	45
300	0.1	0.1	—	800*	—	—	0.025	40	29
		0.25	—	1000*	—	—	0.01	57	34
		0.5	—	1100*	—	—	0.006	60	36
	0.25	0.25	—	1650*	—	—	0.01	56	39
		0.5	—	2050*	—	—	0.0055	66	42
		1.0	—	2350*	—	—	0.003	77	43
	0.5	0.5	—	2850*	—	—	0.0055	61	44
		1.0	—	3600*	—	—	0.003	75	46
		2.0	—	4450*	—	—	0.0015	82	46

■ At 3 volts (RMS) output. ★ At 4 volts (RMS) output.

*Values are for phase-inverter service.

The cathodes of the two units have a common terminal.

RCA RECEIVING TUBE MANUAL

(See page 195 for explanation of symbols)

E _{bb}	R _p	R _g	R _{g2}	R _k	C _{g2}	C _k	C	E _o	V.G.
90	0.1	0.1	-	4400	-	2.7	0.023	5	29☛
		0.22	-	4700	-	2.4	0.013	6	35☛
		0.47	-	4800	-	2.3	0.007	8	41☛
	0.22	0.22	-	7000	-	1.6	0.001	6	39☛
		0.47	-	7400	-	1.4	0.006	9	45■
		1.0	-	7600	-	1.3	0.003	11	48★
	0.47	0.47	-	12000	-	0.9	0.006	9	48■
		1.0	-	13000	-	0.8	0.003	11	52★
		2.2	-	14000	-	0.7	0.002	13	55★
180	0.1	0.1	-	1800	-	4.0	0.025	18	40
		0.22	-	2000	-	3.5	0.013	25	47
		0.47	-	2200	-	3.1	0.006	32	52
	0.22	0.22	-	3000	-	2.4	0.012	24	53
		0.47	-	3500	-	2.1	0.006	34	59
		1.0	-	3900	-	1.8	0.003	39	63
	0.47	0.47	-	5800	-	1.3	0.006	30	62
		1.0	-	6700	-	1.1	0.003	39	66
		2.2	-	7400	-	1.0	0.002	45	68
300	0.1	0.1	-	1300	-	4.6	0.027	43	45
		0.22	-	1500	-	4.0	0.013	57	52
		0.47	-	1700	-	3.6	0.006	66	57
	0.22	0.22	-	2200	-	3.0	0.013	54	59
		0.47	-	2800	-	2.3	0.006	69	65
		1.0	-	3100	-	2.1	0.003	79	68
	0.47	0.47	-	4300	-	1.6	0.006	62	69
		1.0	-	5200	-	1.3	0.003	77	73
		2.2	-	5900	-	1.1	0.002	92	75

25

12AX7
(One Triode
Unit # #)

See Circuit
Diagram 1

☛ At 2 volts (RMS) output. ■ At 3 volts (RMS) output. ★ At 4 volts (RMS) output
The cathodes of the two units have separate terminals.

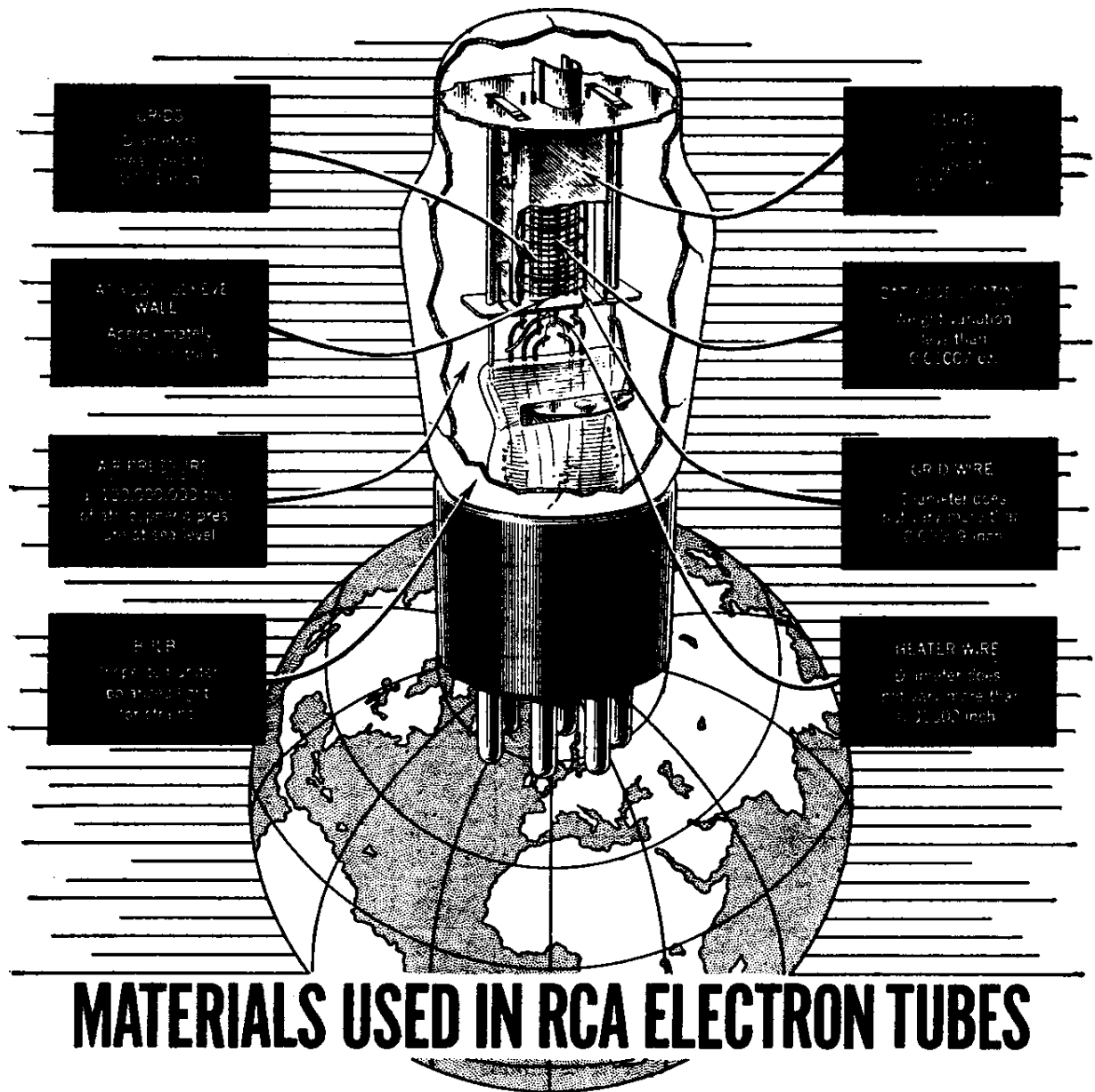

MATERIALS USED IN RCA ELECTRON TUBES

ACETIC ACID — ACETONE
 ALUMINUM — ALUMINUM NITRATE — AMMONIUM CHLORIDE — AMMONIUM HYDROXIDE
 AMYL ACETATE — ANTIMONY — ANTIMONY TRICHLORIDE — ARGON — BAKELITE — BARIUM
 BARIUM CARBONATE — BARIUM NITRATE — BARIUM STRONTIUM TITANATE — BARIUM SULPHATE — BENTONITE — BENZENE — BERYLLIUM — BERYLLIUM OXIDE — BISMUTH — BORIC ACID — BORON — BUTYL ACETATE — BUTYL ALCOHOL — BUTYL CARBITOL — BUTYL CARBITOL ACETATE — CADMIUM — CESIUM — CESIUM CHROMATE — CALCIUM — CALCIUM CARBONATE — CALCIUM NITRATE — CALCIUM OXIDE — CAMPHOR — CARBON — CARBON BLACK — CARBON DIOXIDE — CARBON TETRACHLORIDE — CASTOR OIL — CHLORINE CHROMIC ACID — CHROMIUM — CLAY — COBALT — COPPER — DIACETONE ALCOHOL DIATOL — DIETHYL OXALATE — DISTILLED WATER — ETHER — ETHYL ALCOHOL — FERRIC OXIDE — FERRO TITANIUM — GLASS — GLYCERINE — GOLD — GRAPHITE — HELIUM GAS HYDROCHLORIC ACID — HYDROFLUORIC ACID — HYDROGEN GAS — HYDROGEN PEROXIDE — ILLUMINATING GAS — IRIIDIUM — IRON — ISOLANTITE — ISOPROPANOL — LAVA LEAD — LEAD BORATE — LEAD OXIDE — MAGNESIA — MAGNESIUM — MAGNESIUM NITRATE MALACHITE GREEN — MANGANESE — MARBLE DUST — MERCURY — METHANOL — MICA MISCH METAL — MOLYBDENUM — MONEL — NATURAL GAS — NEON — NICKEL — NICKEL CHLORIDE — NICKEL OXIDE — NICKEL SULPHATE — NITRIC ACID — NITROCELLULOSE NITROGEN — OXALIC ACID — OXYGEN — PALLADIUM — PALMITIC ACID — PETROLEUM JELLY — PHOSPHORIC ACID — PHOSPHORUS — PLATINUM — POTASSIUM — POTASSIUM CARBONATE — POTASSIUM FELDSPAR — POTASSIUM NITRATE — PORCELAIN — RADIUM RARE EARTHS — RESIN (synthetic) — ROSIN — RUBIDIUM — RUBIDIUM DICHROMATE — SHEL-LAC — SILICA — SILICON — SILVER — SILVER OXIDE — SODIUM — SODIUM CARBONATE STANNIC OXIDE — STEEL — STRONTIUM — STRONTIUM CARBONATE — STRONTIUM NITRATE SULPHUR — SULPHURIC ACID — TALC — TANTALUM — THALLIUM — THORIUM — THORIUM NITRATE — TIN — TITANIUM — TITANIUM DIOXIDE — TRICHLORETHYLENE — TUNGSTEN WAX — WHEAT FLOUR — WOOD FIBER — XENON — ZINC — ZIRCONIUM HYDRIDE

Circuits

The circuit diagrams in this Manual have been conservatively designed to illustrate some of the more important applications of receiving tubes and are not necessarily representative of commercial practice.

The circuits for receivers and amplifiers are capable of good response, but the fidelity obtained depends as much on the quality of the components used as on the circuits themselves. The quality of loud-speakers, transformers, chokes, and input sources is especially important.

Electrical specifications have been given for the circuit components to assist those interested in home construction. Details for mechanical layout have been omitted because they vary widely with the requirements of the individual set builder and are dependent upon the size, shape, and quality of the commercial components selected. For the various *rf*, *if*, and oscillator coils, commercial units are recommended. These can be purchased through your local dealer by specifying the tuning range, size of tuning capacitors, intermediate frequency, type of converter tube, and type of oscillator coil. The voltage ratings of the capacitors specified in these circuits are the dc working voltages. The wattage ratings of the resistors specified assume provisions for adequate ventilation; for compact installations having poor ventilation, higher-wattage resistors may be required.

Information on the characteristics and the application features of each tube will be found in the **TUBE TYPES SECTION**. This information will prove of assistance in understanding and utilizing the circuits.

The following circuits will be found in the subsequent pages:

	<i>Circuit No.</i>
Portable Superheterodyne Receiver	15-1
Portable 3-Way Superheterodyne Receiver	15-2
AC-Operated Superheterodyne Receiver	15-3
AC/DC Superheterodyne Receiver	15-4
Automobile Receiver	15-5
Superregenerative Receiver	15-6
FM Tuner	15-7
AC-Operated Regenerative Short-Wave Receiver	15-8
Battery-Operated Short-Wave Receiver	15-9
High-Power Audio Amplifier	15-10
Class B Amplifier for Mobile Use	15-11
Class A ₁ Audio Amplifier	15-12
Two-Channel Audio Mixer	15-13
Non-Motorboating Resistance-Coupled Amplifier	15-14
Code Practice Oscillator	15-15
AF Voltage Amplifier with Signal Mixer, Master Mixer, and Compressor-Expander	15-16
Microphone and Phonograph Amplifier	15-17
Intercommunication Set	15-18
Electronic Volt-Ohm Meter	15-19

(15-1)

PORTABLE SUPERHETERODYNE RECEIVER

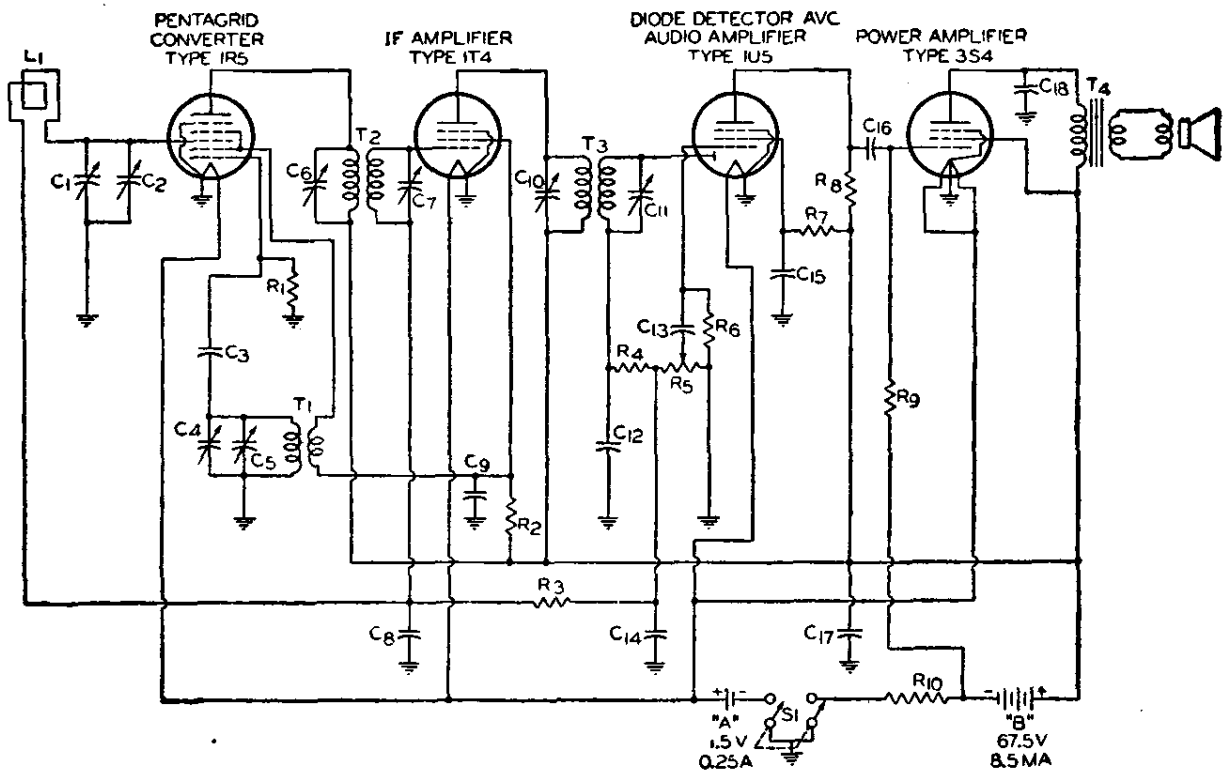

C₁ C₄ = Ganged tuning capacitors: C₁, 10-274 μ mf; C₄, 7.5-122.5 μ mf
 C₂ C₅ = Trimmer capacitors, 2-15 μ mf
 C₃ = 56 μ mf, ceramic
 C₆ C₇ C₁₀ C₁₁ = Trimmer capacitors
 C₈ = 0.05 μ f, tubular, 400 v.
 C₉ C₁₅ = 0.02 μ f, tubular, 100 v.
 C₁₂ = 82 μ mf, ceramic
 C₁₃ C₁₆ = 0.002 μ f, tubular, 150 v.
 C₁₄ = 33 μ mf, ceramic

C₁₇ = 10 μ f, electrolytic, 60 v.
 C₁₈ = 0.005 μ f, tubular, 600 v.
 L₁ = Loop antenna, 550-1600 kc
 R₁ = 0.1 megohm, 0.25 watt
 R₂ = 15000 ohms, 0.25 watt
 R₃ R₉ = 3.3 megohms, 0.25 watt
 R₄ = 68000 ohms, 0.25 watt
 R₅ = Volume control, potentiometer, 2 megohms
 R₆ = 10 megohms, 0.25 watt
 R₇ = 4.7 megohms, 0.25 watt
 R₈ = 1 megohm, 0.25 watt

R₁₀ = 820 ohms, 0.25 watt
 S₁ = Switch, double-pole, single-throw
 T₁ = Oscillator coil, tapped; for use with tuning capacitor of 7.5-122.5 μ mf, and 455 kc if transformer
 T₂ T₃ = Intermediate-frequency transformers, 455 kc
 T₄ = Output transformer for matching impedance of voice coil to 5000-ohm tube load

(15-2)

PORTABLE 3-WAY SUPERHETERODYNE RECEIVER

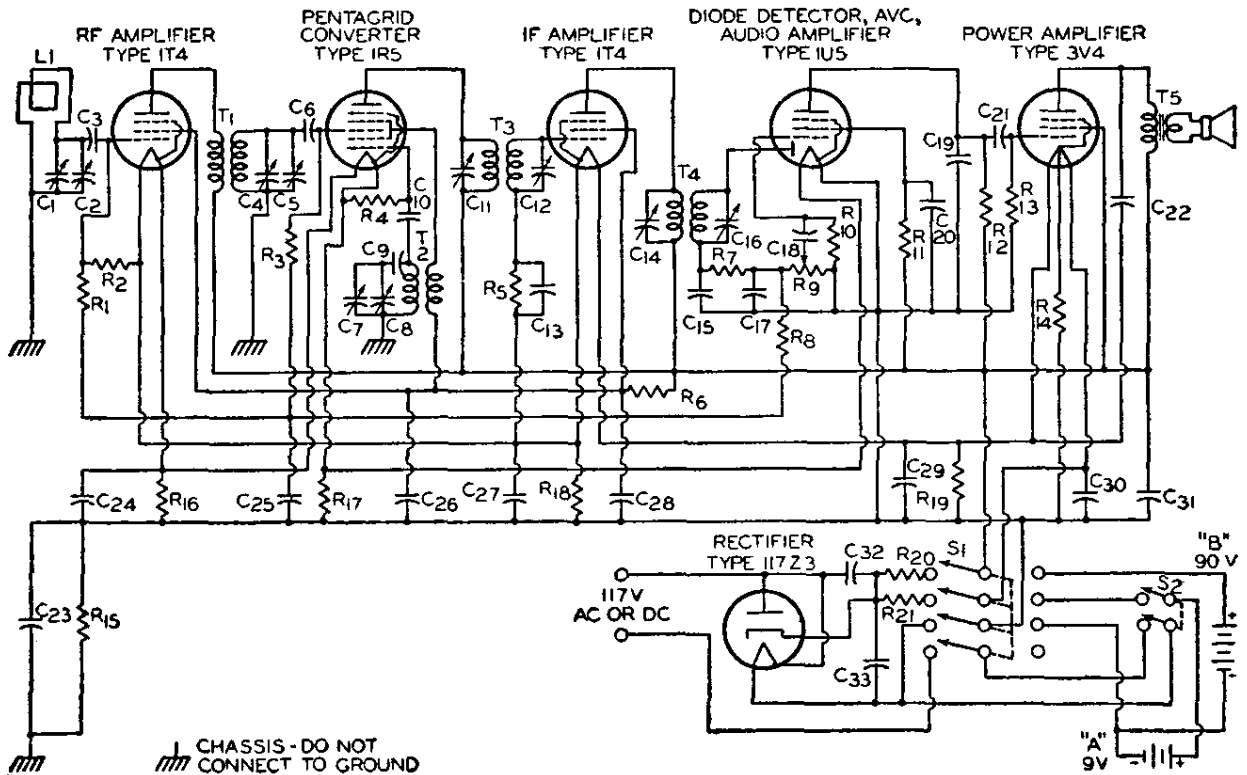

C₁ C₄ C₃ = Ganged tuning capacitors, 20-450 μf
 C₂ C₅ C₇ C₁₁ C₁₂ C₁₄ C₁₆ = Trimmer capacitors
 C₃ C₁₀ C₁₅ C₁₇ = 100 μf, ceramic
 C₅ = 82 μf, ceramic
 C₉ = 560 μf, ceramic
 C₁₃ = 0.01 μf, tubular, 400 v.
 C₁₈ C₂₁ = 0.002 μf, tubular, 400 v.
 C₁₉ = 270 μf, ceramic
 C₂₀ = 0.02 μf, tubular, 400 v.
 C₂₂ C₃₂ = 0.005 μf, tubular, 400 v.
 C₂₃ = 0.1 μf, 400 v.
 C₂₄ = 0.05 μf, 200 v.
 C₂₅ C₂₆ C₂₇ C₂₈ = 0.05 μf, 400 v.
 C₂₉ = 40 μf, 25 v.

C₃₀ = 160 μf, 25 v.
 C₃₁ C₃₃ = 20 μf, 150 v.
 L₁ = Loop antenna, 540-1600 kc
 R₁ R₂ R₁₁ = 4.7 megohms, 0.25 watt
 R₃ = 2.2 megohms, 0.25 watt
 R₄ = 0.10 megohm, 0.25 watt
 R₅ = 5.6 megohms, 0.25 watt
 R₆ = 0.027 megohm, 0.25 watt
 R₇ = 0.068 megohm, 0.25 watt
 R₈ = 3.3 megohms, 0.25 watt
 R₉ = Volume control, potentiometer, 1 megohm
 R₁₀ = 10 megohms, 0.25 watt
 R₁₂ = 0.220 megohm, 0.25 watt
 R₁₃ = 1 megohm, 0.25 watt
 R₁₄ R₁₅ = 1800 ohms, 0.25 watt
 R₁₅ = 0.220 megohm, 0.5 watt
 R₁₇ = 1000 ohms, 0.25 watt

R₁₈ = 2700 ohms, 0.25 watt
 R₁₉ = 1500 ohms, 0.25 watt
 R₂₀ = 1800 ohms, 10 watts
 R₂₁ = 2300 ohms, 10 watts
 S₁ = Switch, 4-pole double-throw
 S₂ = Switch, double-pole, single-throw
 T₁ = RF transformer, 540-1600 kc
 T₂ = Oscillator coil for use with a 560-μf padder, 20-450 μf tuning capacitor, and 455 kc if transformer
 T₃ T₄ = Intermediate-frequency transformers, 455 kc
 T₅ = Output transformer for matching impedance of voice coil to 10000-ohm tube load

(15-3)

AC-OPERATED SUPERHETERODYNE RECEIVER

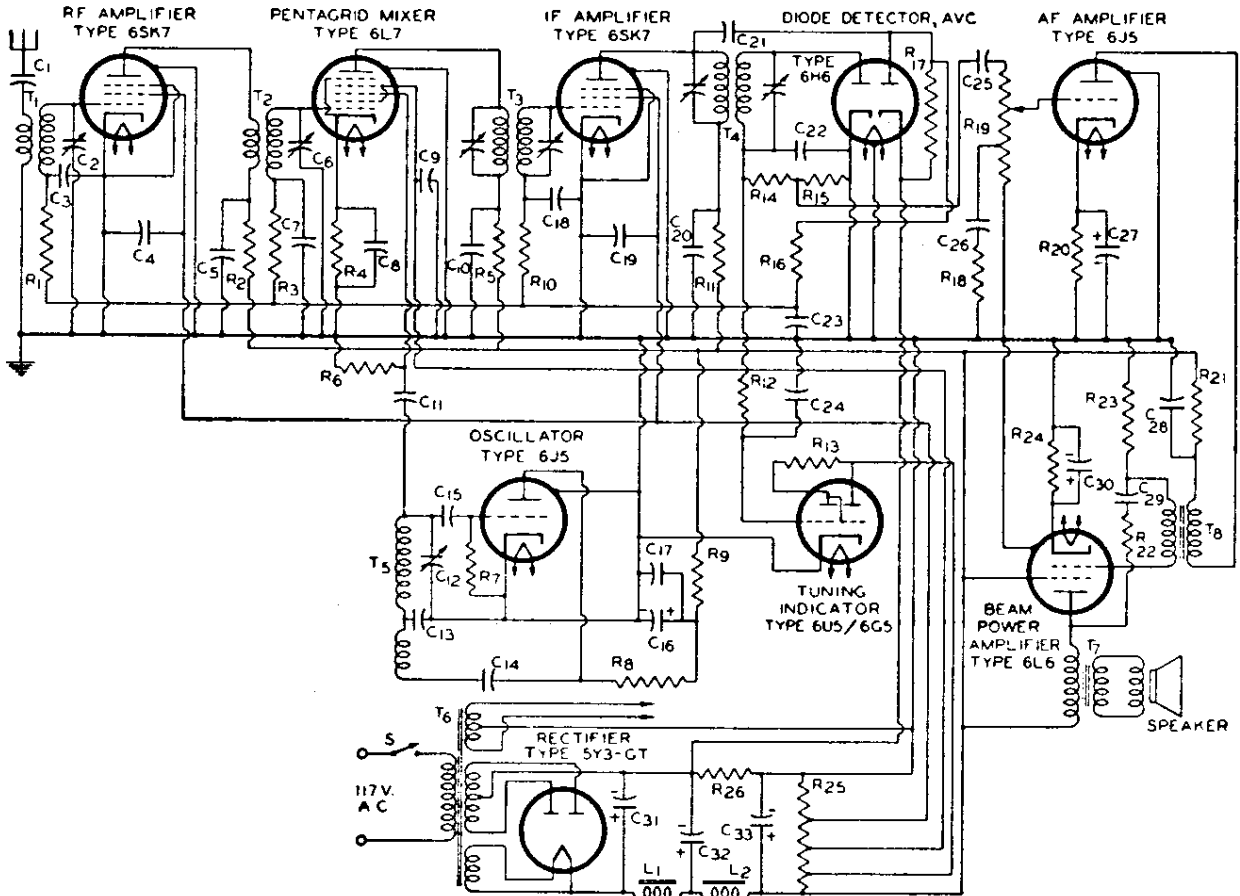

- C₁ = 50 to 200 μ f
- C₂ C₆ C₁₂ = Ganged tuning capacitors, 365 μ f
- C₃ C₇ C₁₈ C₂₃ C₂₄ C₂₅ = 0.05 μ f, paper
- C₄ C₉ C₁₉ = 0.25 μ f, paper
- C₅ C₈ C₁₀ C₁₇ C₂₀ = 0.1 μ f paper
- C₁₁ C₂₂ = 100 μ f
- C₁₃ = Oscillator padding capacitor—follow oscillator-coil manufacturer's recommendation
- C₁₄ C₂₆ = 0.01 μ f
- C₁₅ C₂₁ = 50 μ f
- C₁₆ C₂₁ C₂₂ C₂₃ = 8 μ f electrolytic, 500 v.
- C₂₇ = 10 μ f, electrolytic, 25 v.
- C₂₈ = 1 μ f, paper, 400 v.
- C₂₉ = 0.5 μ f, paper, 400 v.
- C₃₀ = 25 μ f, electrolytic, 25 v.

- L₁ = 20 henries, 100 ohms, 120 ma.
- L₂ = Speaker field, 500 ohms, 8 watts
- R₁ R₃ R₁₀ = 100000 ohms, 0.5 watt
- R₂ R₁₁ = 2000 ohms, 0.5 watt
- R₄ = 260 ohms, 0.5 watt
- R₅ = 3300 ohms, 0.5 watt
- R₆ R₇ R₁₄ = 50000 ohms, 0.5 watt
- R₈ R₉ = 20000 ohms, 0.5 watt
- R₁₂ = 2 megohms, 0.5 watt
- R₁₃ R₁₆ R₁₇ = 1 megohm, 0.5 watt
- R₁₅ = 200000 ohms, 0.5 watt
- R₁₈ = 27000 ohms, 0.5 watt
- R₁₉ = Volume control, potentiometer, 1 megohm with tap at 250000 ohms for tone compensation
- R₂₀ = 900 ohms, 0.5 watt

- R₂₁ = 2000 ohms, 0.5 watt
- R₂₂ = 90000 ohms, 0.5 watt
- R₂₃ = 10000 ohms, 0.5 watt
- R₂₄ = 170 ohms, 2 watts
- R₂₅ = 20000 ohms, 5 watts
- R₂₆ = 25 ohms, 0.5 watt
- T₁ T₂ = RF transformers, 540-1600 kc
- T₃ T₄ = Intermediate-frequency transformers, 455 kc
- T₅ = Oscillator coil for use with 365- μ f tuning capacitor, and 455 kc if transformer
- T₆ = Power transformer, 350-0-350 volts RMS, 120 ma. dc
- T₇ = Output transformer for matching impedance of voice coil to a 2500-ohm tube load
- T₈ = Interstage transformer for matching a 6J5 to a single 6L6 as class A₁ amplifier

(15-4)

AC/DC SUPERHETERODYNE RECEIVER

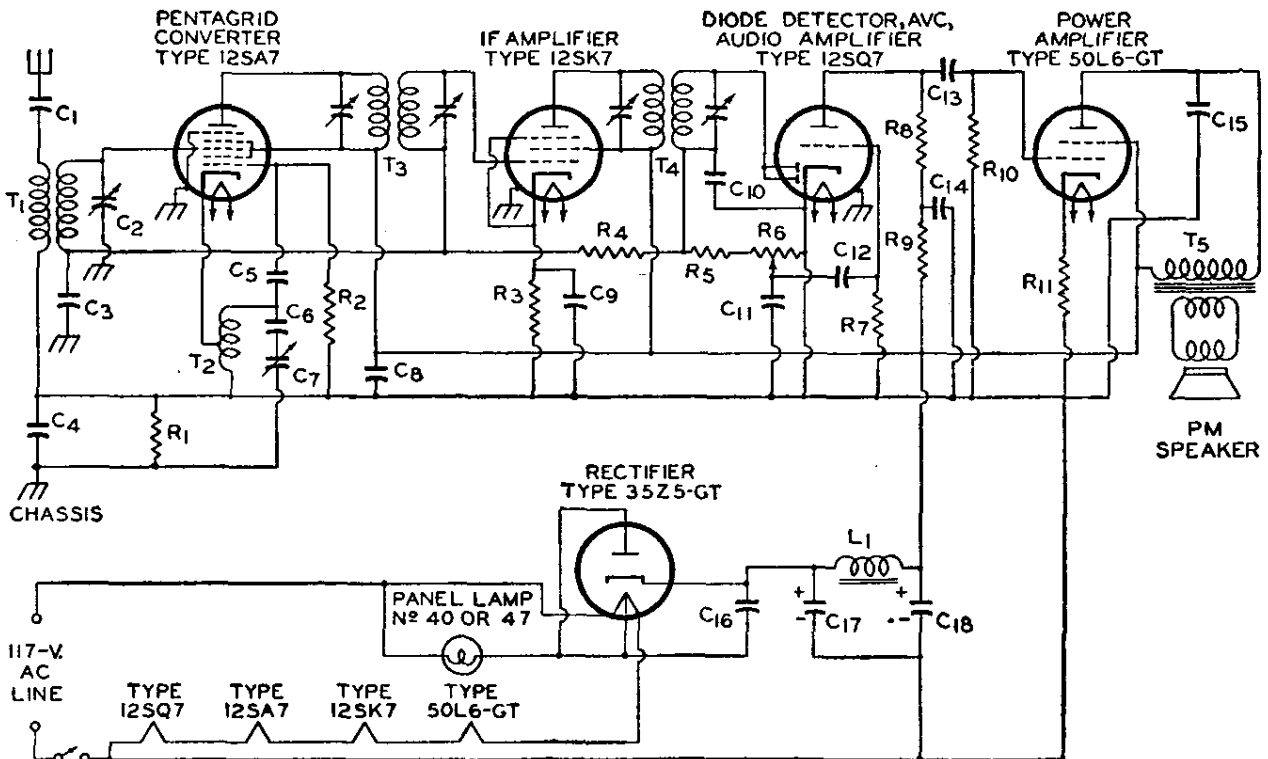

C₁ = 500 μ f
C₂ C₇ = Ganged tuning capacitors, 365 μ f
C₃ C₈ C₁₄ C₁₆ = 0.1 μ f, paper
C₄ = 0.25 μ f, paper
C₅ = 50 μ f
C₆ = Oscillator padding capacitor—follow oscillator-coil manufacturer's recommendation
C₉ = 0.05 μ f, paper
C₁₀ C₁₁ = 250 μ f
C₁₂ = 0.005 μ f

C₁₃ = 0.01 μ f, paper
C₁₅ = 0.025 μ f
C₁₇ C₁₈ = 40 μ f, electrolytic, 150 v.
L₁ = Filter choke, 200 ohms, inductance as large as practical
R₁ R₈ = 250000 ohms, 0.5 watt
R₂ = 20000 ohms, 0.5 watt
R₃ = 260 ohms, 0.5 watt
R₄ = 2 megohms, 0.5 watt
R₅ R₉ = 50000 ohms, 0.5 watt
R₆ = Volume control, potentiometer, 250000 ohms
R₇ = 10 megohms, 0.5 watt

R₁₀ = 0.5 megohm, 0.5 watt
R₁₁ = 150 ohms, 1 watt
T₁ = RF transformer, 540-1600 kc
T₂ = Oscillator coil, tapped, for use with 365- μ f tuning capacitor, and 455 kc if transformer
T₃ T₄ = Intermediate-frequency transformers, 455 kc
T₅ = Output transformer for matching impedance of voice coil to 2500-ohm tube load

(15-5)

AUTOMOBILE RECEIVER

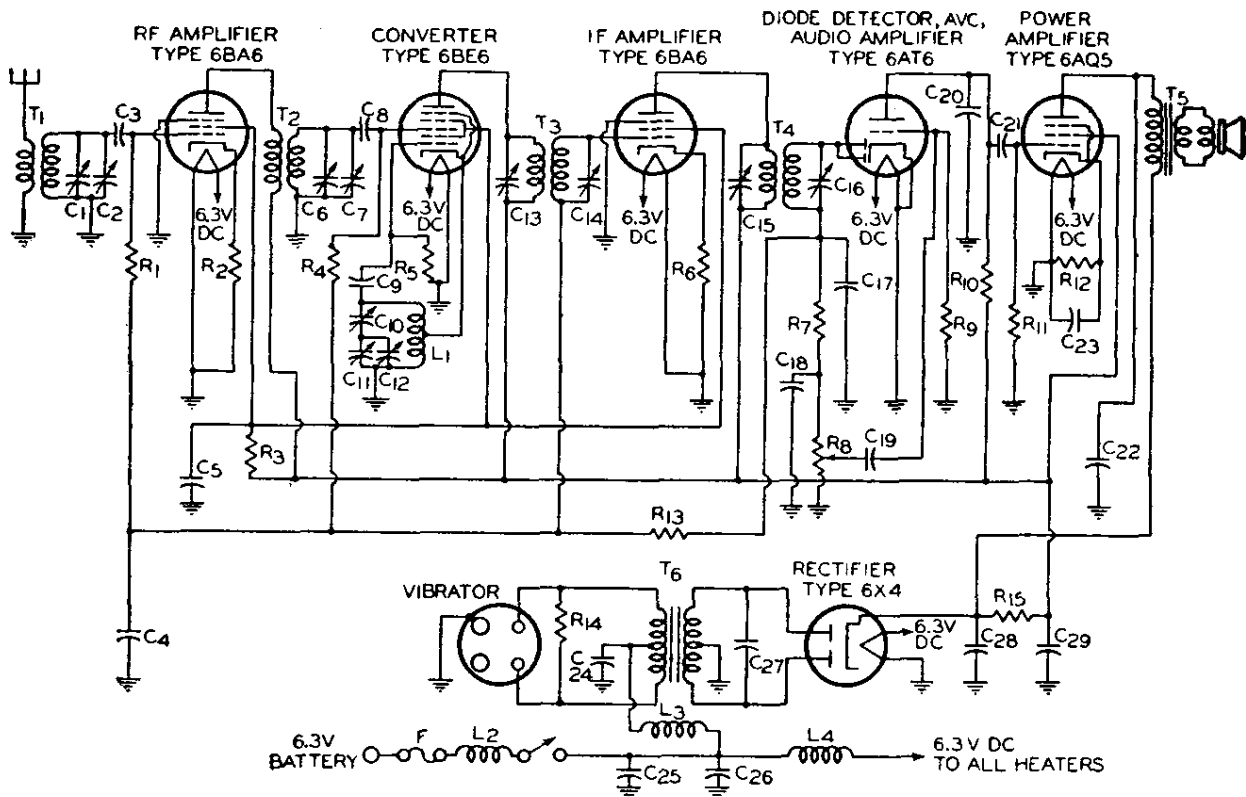

C₁ C₇ C₁₁ = Ganged tuning capacitors, 365 $\mu\mu\text{f}$
 C₂ C₆ C₁₂ = Trimmer capacitors, 4-30 $\mu\mu\text{f}$
 C₃ C₈ = 220 $\mu\mu\text{f}$, mica
 C₄ = 0.05 μf , paper, 50 v.
 C₅ = 0.05 μf , paper, 300 v.
 C₉ = 47 $\mu\mu\text{f}$, mica
 C₁₀ = Oscillator padding capacitor—follow oscillator-coil manufacturer's recommendation
 C₁₃ C₁₄ C₁₅ C₁₆ = Trimmer capacitors for if transformers
 C₁₇ C₁₈ = 100 $\mu\mu\text{f}$, mica
 C₁₉ = 0.01 μf , paper, 50 v.
 C₂₀ = 120 $\mu\mu\text{f}$, mica
 C₂₁ = 0.005 μf , paper, 300 v.
 C₂₂ = 0.005 μf , paper, 450 v.

C₂₃ = 20 μf , electrolytic, 25 v.
 C₂₄ C₂₆ = 0.5 μf , paper, 50 v.
 C₂₅ = 470 $\mu\mu\text{f}$, mica
 C₂₇ = 0.006 μf , paper, 1500 v.
 C₂₈ C₂₉ = 20 μf , electrolytic, 450 v.
 F = Fuse, 10 a.
 L₁ = Oscillator coil, tapped, for use with 365- $\mu\mu\text{f}$ tuning capacitor, and 455 kc if transformer
 L₂ L₃ L₄ = RF choke, 10 a.
 R₁ R₄ = 1 megohm, 0.5 watt
 R₂ = 150 ohms, 0.5 watt
 R₃ = 12000 ohms, 2 watts
 R₅ = 22000 ohms, 0.5 watt
 R₆ = 100 ohms, 0.5 watt
 R₇ = 47000 ohms, 0.5 watt
 R₈ = Volume control, potentiometer, 1 megohm

R₉ = 10 megohms, 0.5 watt
 R₁₀ = 0.27 megohm, 0.5 watt
 R₁₁ = 0.47 megohm, 0.5 watt
 R₁₂ = 390 ohms, 2 watts
 R₁₃ = 2.2 megohms, 0.5 watt
 R₁₄ = 220 ohms, 0.5 watt
 R₁₅ = 1500 ohms, 1 watt
 T₁ T₂ = RF transformers, 540-1600 kc
 T₃ T₄ = Intermediate-frequency transformers, 455 kc
 T₅ = Output transformer for matching impedance of voice coil to 5000-ohm tube load
 T₆ = Vibrator transformer, Stancor P-4062, or equivalent
 Vibrator = Mallory Type No. 859, or equivalent

(15-6)

SUPERREGENERATIVE RECEIVER

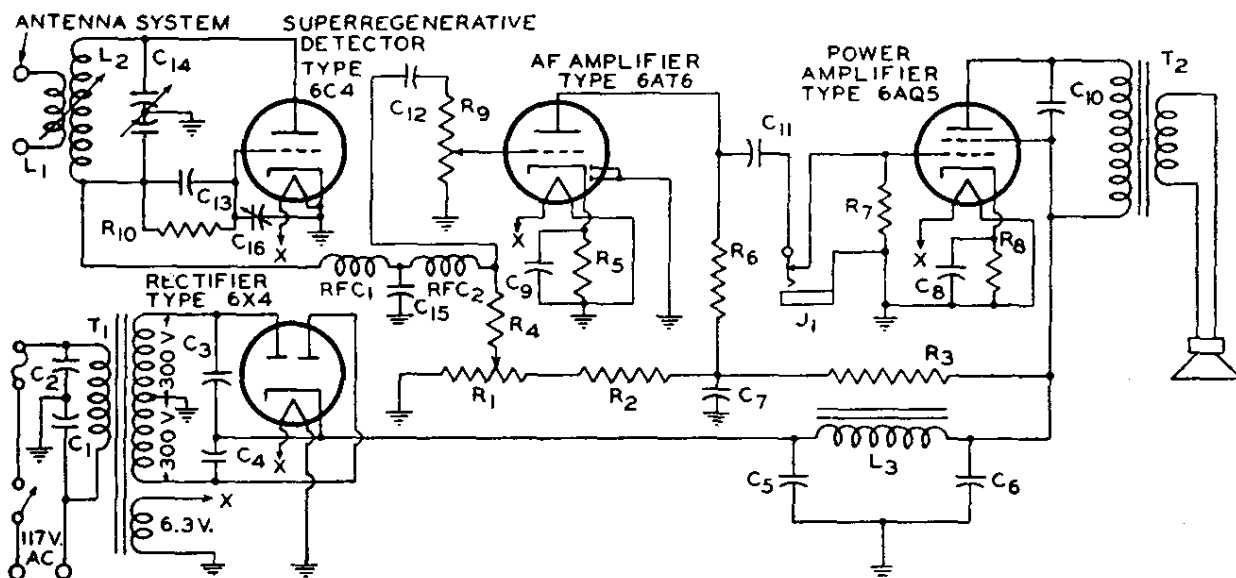

C₁ C₂ = 0.1 μ f, paper, 400 v.
 C₃ C₄ = 100 μ f, mica, 500 v.
 C₅ C₆ C₇ = 20 μ f, electrolytic, 450 v.
 C₈ = 25 μ f, electrolytic, 50 v.
 C₉ = 25 μ f, electrolytic, 25 v.
 C₁₀ = 0.002 μ f, paper, 600 v.
 C₁₁ = 0.01 μ f, paper, 400 v.
 C₁₂ = 0.005 μ f, paper, 400 v.
 C₁₃ = 50 μ f, mica, 300 v.
 C₁₄ = 10 μ f max. per section
 C₁₅ = 0.006 μ f, mica, 300 v.
 C₁₆ = 3-30 μ f, ceramic or mica
 J₁ = Jack for earphones

L₁ = Antenna pickup loop
 L₂ = 4 turns of No. 12 copper wire on a $\frac{1}{2}$ " I.D. form (144 Mc): adjust spacing to set band
 L₃ = Speaker field or filter choke, 12 henries, 70 ma.
 R₁ = Potentiometer, 47000 ohms, 1 watt, wire wound
 R₂ R₃ = 47000 ohms, 1 watt
 R₄ = 27000 ohms, 0.5 watt
 R₅ = 2700 ohms, 1 watt
 R₆ R₇ = 0.1 megohm, 0.5 watt

R₈ = 270 ohms, 1 watt
 R₉ = Volume control, potentiometer, 500000 ohms
 R₁₀ = 4.7 megohms, 0.5 watt
 RFC₁ = One-quarter wavelength of No. 23 Enam. close wound on a $\frac{1}{4}$ " form (144 Mc)
 RFC₂ = RF choke, 8 mh.
 T₁ = Power transformer, 300-0-300 volts RMS, 70 ma.
 T₂ = Output transformer for matching impedance of voice coil to 5000-ohm tube load

(15-7)

FM TUNER

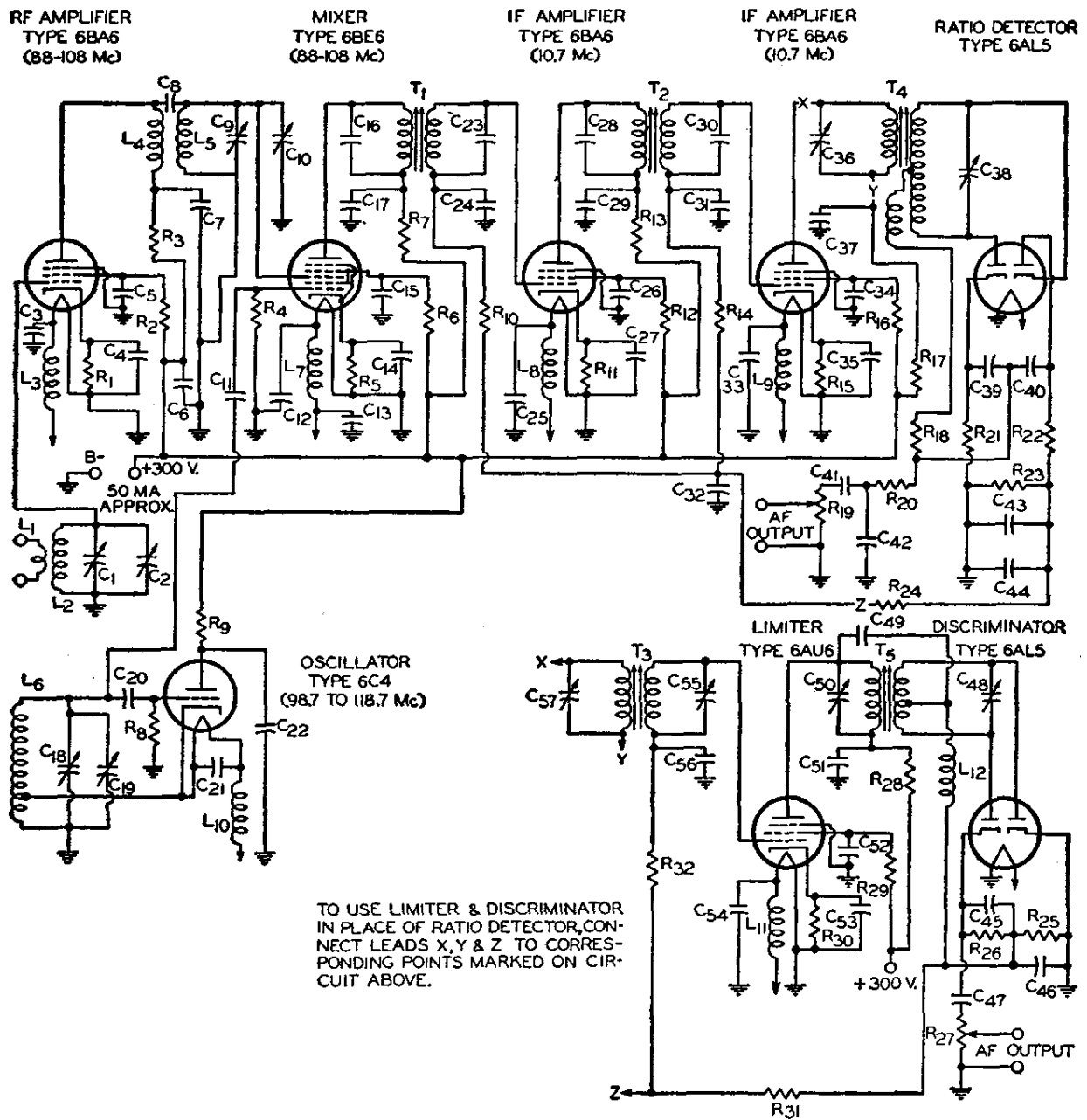

(15-7)

FM TUNER (Cont'd)

- | | | |
|--|--|--|
| <p>C₁ C₉ C₁₈ = Ganged tuning capacitors, 7.5 - 20 μmf
 C₂ C₁₀ C₁₉ = Trimmer capacitors, 1.5 - 5.0 μmf
 C₃ = 0.01 μf, mica, 200 v.
 C₄ C₁₄ C₂₄ C₂₇ C₃₁ C₃₅ C₃₃ C₅₅ = 1500 μmf, mica, 200 v.
 C₅ C₇ C₁₅ C₁₇ C₂₂ C₂₆ C₂₉ C₃₄ C₃₇ C₅₂ = 1500 μmf, mica, 400 v.
 C₆ = 0.1 μf, paper, 400 v.
 C₈ = 33 μmf, mica, 400 v.
 C₁₁ = 3 μmf, mica, 200 v.
 C₁₂ C₂₅ C₃₂ C₃₃ C₅₄ = 0.01 μf, paper, 200 v.
 C₁₃ = 0.01 μf, paper, 200 v.
 C₁₆ C₂₂ C₂₈ C₃₀ C₃₆ C₃₈ C₄₃ C₄₉ C₅₀ C₅₅ C₅₇ = Trimmer capacitors, 22-50 μmf, mica, usually part of if transformer
 C₂₀ = 33 μmf, mica, 200 v.
 C₂₁ = 100 μmf, mica, 200 v.
 C₃₉ C₄₀ = 330 μmf, mica, 200 v.
 C₄₁ = 0.05 μf, paper, 200 v.
 C₄₂ C₄₃ = 0.005 μf, paper, 200 v.</p> | <p>C₄₄ = 10 μf, electrolytic, 200 v.
 C₄₅ C₄₆ = 250 μmf, mica, 200 v.
 C₄₇ = 0.1 μf, mica, 200 v.
 C₅₁ = 500 μmf, mica, 400 v.
 L₁ = 1 turn of No.14 Enam. wound on a $\frac{3}{4}$" diam. coil form
 L₂ = 2.5 turns of No.14 Enam. spaced 1 wire diameter wound on same form as L₁ with the ground end of L₂ spaced $\frac{1}{4}$" from L₁
 L₃ L₄ L₇ L₈ L₉ L₁₀ L₁₁ = Choke, 1 μh (approx.), 25 turns of No.24 Enam. close-wound on resistor (47000 ohms, 0.5 watt), connected in parallel with resistor.
 L₅ = 2.5 turns of No.14 Enam. spaced 1 wire diameter, wound on $\frac{3}{4}$" form.
 L₆ = 2 turns of No.14 Enam. spaced 1 wire diameter, wound on $\frac{3}{4}$" form, tapped</p> | <p>at $\frac{1}{8}$ turn from ground end
 L₁₂ = Choke, 2.5 mh.
 R₁ R₅ = 50 ohms, 0.5 watt
 R₂ R₁₂ R₁₆ = 0.04 megohm, 0.5 watt
 R₃ R₇ R₁₃ R₁₇ = 500 ohms, 0.5 watt
 R₄ R₂₃ = 0.01 megohm, 0.5 watt
 R₆ = 0.03 megohm, 1 watt
 R₈ = 0.05 megohm, 0.5 watt
 R₉ = 0.005 megohm, 1 watt
 R₁₀ R₁₄ R₃₂ = 0.2 megohm, 0.5 watt
 R₁₁ R₁₅ R₃₀ = 68 ohms, 0.5 watt
 R₁₈ = 56 ohms, 0.5 watt
 R₁₉ R₂₇ = Volume controls, potentiometers, 1 megohm
 R₂₀ = 0.015 megohm, 0.5 watt
 R₂₁ = 820 ohms, 0.5 watt
 R₂₂ = 560 ohms, 0.5 watt
 R₂₄ R₃₁ = 2 megohms, 0.5 watt
 R₂₅ R₂₆ R₂₈ = 0.100 megohm 0.5 watt
 R₂₉ = 0.15 megohm, 1 watt</p> |
|--|--|--|

Fig. 15-7 illustrates the circuit for an FM tuner. The basic circuit has been arranged to show the use of a ratio detector, but the limiter/discriminator circuit shown in the lower right-hand corner of the diagram can be substituted as described above.

A word of caution is necessary in connection with this circuit. Because it works at very high frequencies and is required to handle a very wide bandwidth, its construction requires more than ordinary skill and equipment. Placement of component parts is quite critical in a receiver of this nature and requires careful experimentation. All rf leads to components including bypass capacitors must be kept short and must be properly dressed to minimize intercoupling and capacitance effects. The minimum equipment required for circuit alignment and oscillator tracking calls for a frequency-modulated signal generator and a high-impedance vacuum-tube voltmeter. Unless the builder has the necessary equipment and has had considerable experience with broad-band, high-frequency circuits, he should not undertake the construction of this circuit.

(15-8)

AC-OPERATED REGENERATIVE SHORT-WAVE RECEIVER

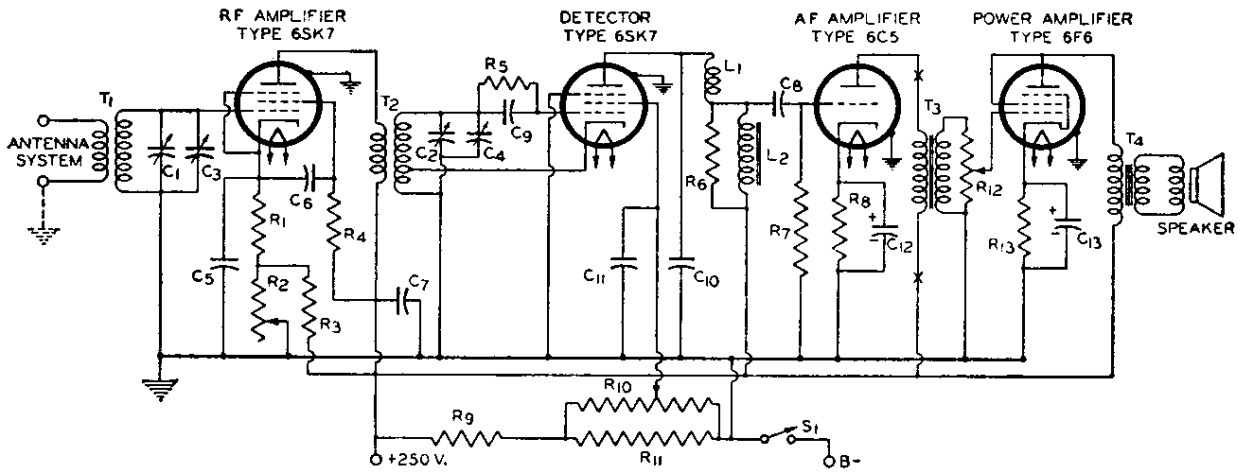

R₁₁ = 5000 OHMS, 1 WATT

- C₁ C₂ = 35 μf
- C₃ C₄ = Midget tuning capacitors, 140 μf
- C₅ C₆ C₇ = 0.05 μf
- C₈ = 0.01 μf, 400 v.
- C₉ C₁₀ = 0.00025 μf, mica
- C₁₁ = 1 μf, 200 v.
- C₁₂ = 8 μf, electrolytic, 25 v.
- C₁₃ = 16 μf, electrolytic, 25 v.
- L₁ = RF choke, 8 mh.
- L₂ = AF choke, 300-500 h.
- R₁ = 250 ohms, 0.5 watt
- R₂ = Potentiometer, 10000 ohms, wire wound
- R₃ = 100000 ohms, 1 watt
- R₄ = 60000 ohms, 1 watt

- R₅ = 2 to 5 megohms, 0.5 watt
- R₆ = 250000 ohms, 1 watt
- R₇ = 1 megohm, 0.5 watt
- R₈ = 1000 ohms, 1 watt
- R₉ = 15000 ohms, 5 watts
- R₁₀ = Regeneration control, potentiometer, 500000 ohms
- R₁₁ = 5000 ohms, 1 watt
- R₁₂ = Volume control, potentiometer, 500000 ohms
- R₁₃ = 670 ohms, 1 watt
- S₁ = Switch, single-pole, single-throw
- T₁ = RF coil of the 4-prong,

- plug-in type for use with a 140-μf tuning capacitor
- T₂ = Regenerative detector coil of the 5-prong, 2-winding, plug-in type with tapped grid winding for electron-coupled circuit
- T₃ = Interstage transformer for matching a 6C5 to a single 6F6 as a triode-connected class A₁ amplifier
- T₄ = Output transformer for matching impedance of voice coil to a 4000-ohm tube load
- X-X = Insert double-circuit 'phone jack here

(15-9)

BATTERY-OPERATED SHORT-WAVE RECEIVER 1.4-Volt Types

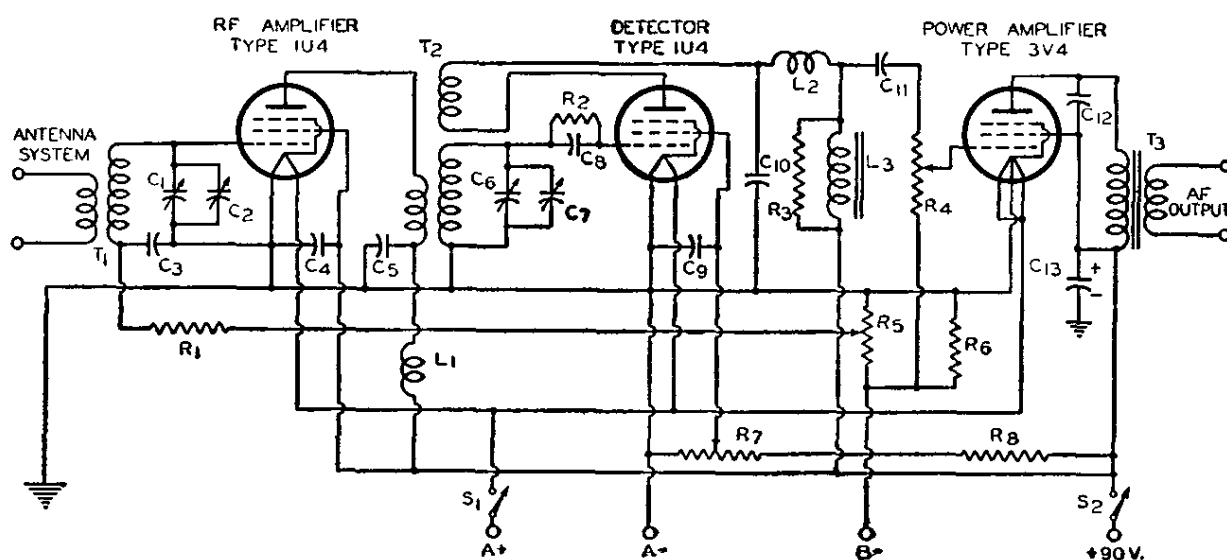

C₁ C₆ = Midget tuning capacitors, 140 μf
C₂ C₇ = 35 μf
C₃ C₄ C₅ C₁₁ = 0.05 μf
C₈ C₁₀ = 0.00025 μf
C₉ = 1 μf
C₁₂ = 0.002 μf
C₁₃ = 8 μf , electrolytic, 100 v.
L₁ L₂ = RF chokes, 8 mh.
L₃ = AF choke, 300-500 h.

R₁ = 100000 ohms, 0.5 watt
R₂ = 2 - 5 megohms, 0.5 watt
R₃ = 0.25 megohm, 0.5 watt
R₄ = Volume control, potentiometer, 0.5 megohm
R₅ R₇ = Potentiometers, 50000 ohms
R₆ = 470 ohms, 0.5 watt
R₈ = 30000 ohms, 0.5 watt
S₁ S₂ = Ganged switch, double-pole, single-throw

T₁ = RF coil of the 4-prong, 2-winding, plug-in type for use with 140- μf tuning capacitor
T₂ = Regenerative detector coil of the 6-prong, 3-winding, plug-in type for use with 140- μf tuning capacitor
T₃ = Output transformer for matching impedance of voice coil to 9000-ohm tube load

(15-10)

HIGH-POWER AUDIO-AMPLIFIER

Class AB₂ 6L6's, Output 45 Watts

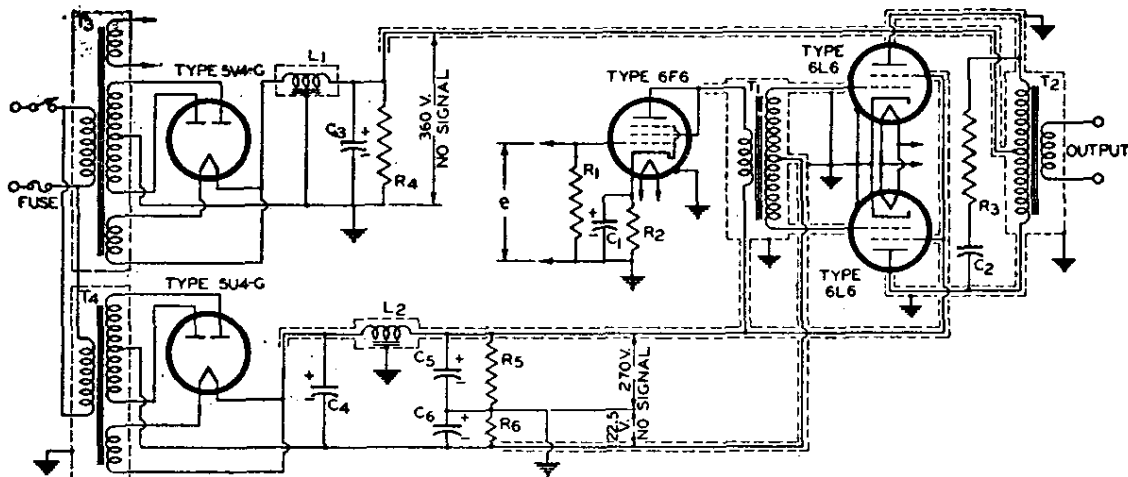

- C₁ C₆ = 25 μf, electrolytic, 25 v.
- C₂ = 0.035 μf, 1000 v.
- C₃ = 16 μf, electrolytic, 450 v.
- C₄ C₅ = 8 μf, electrolytic, 450 v.
- L₁ = Filter choke, 5 henries at 220 ma., 50 ohms or less
- L₂ = Filter choke, 20 henries at 150 ma., 100 ohms or less
- R₁ = 0.5 megohm, 0.5 watt

- R₂ = 650 ohms, 0.5 watt
- R₃ = 5000 ohms, 20 watts
- R₄ = 50000 ohms, 5 watts
- R₅ = 3500 ohms, 30 watts
- R₆ = 200 ohms, 5 watts
- T₁ = Interstage transformer for matching a single 6F6 to push-pull 6L6's as class AB₂ amplifiers

- T₂ = Output transformer for matching the impedance of voice coil to a 3800-ohm plate-to-plate tube load
- T₃ = Power transformer, 440-0-440 volts RMS, 175 ma. dc
- T₄ = Power transformer, 315-0-315 volts RMS, 150 ma. dc

(15-11)

CLASS B AMPLIFIER FOR MOBILE USE

Power Output 10 Watts*

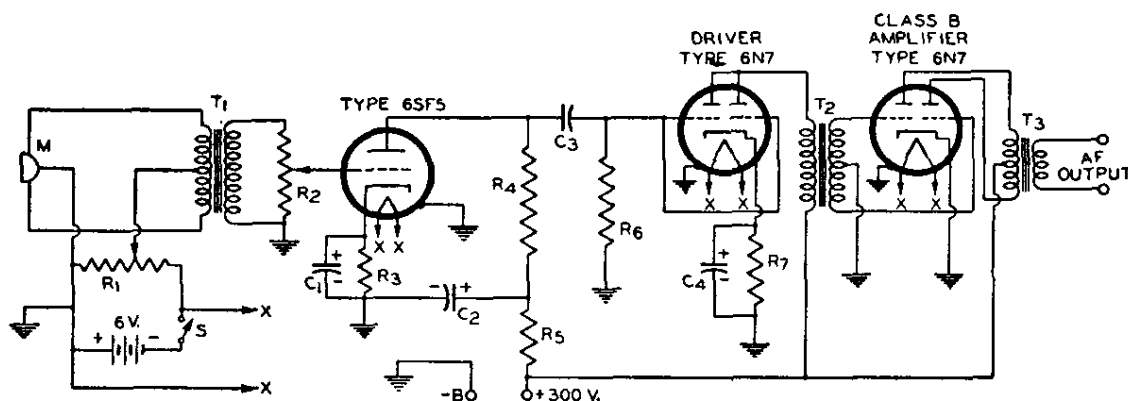

- C₁ = 5 μf, electrolytic, 25 v.
- C₂ = 4 μf, electrolytic, 250 v.
- C₃ = 0.025 μf
- C₄ = 25 μf, electrolytic, 25 v.
- M = Microphone, double-button
- R₁ = Potentiometer, 500 ohms, wire wound
- R₂ = Volume control, potentiometer, 500000 ohms

- R₃ = 1300 ohms, 0.5 watt
- R₄ = 100000 ohms, 0.5 watt
- R₅ = 50000 ohms, 0.5 watt
- R₆ = 100000 ohms, 0.5 watt
- R₇ = 900 ohms, 0.5 watt
- S = Microphone and heater switch
- T₁ = Transformer for matching a double-button microphone

- to a single grid
- T₂ = Input transformer for matching parallel-connected 6N7 to a 6N7 class B amplifier
- T₃ = Output transformer for matching impedance of voice coil to 8000-ohm plate-to-plate tube load

* Peak signal-input voltage to 6SF5 grid is 0.15 volt for full power output

(15-12)

CLASS A₁ AUDIO AMPLIFIER

For Use On DC Power Line—Power Output, 4 Watts*

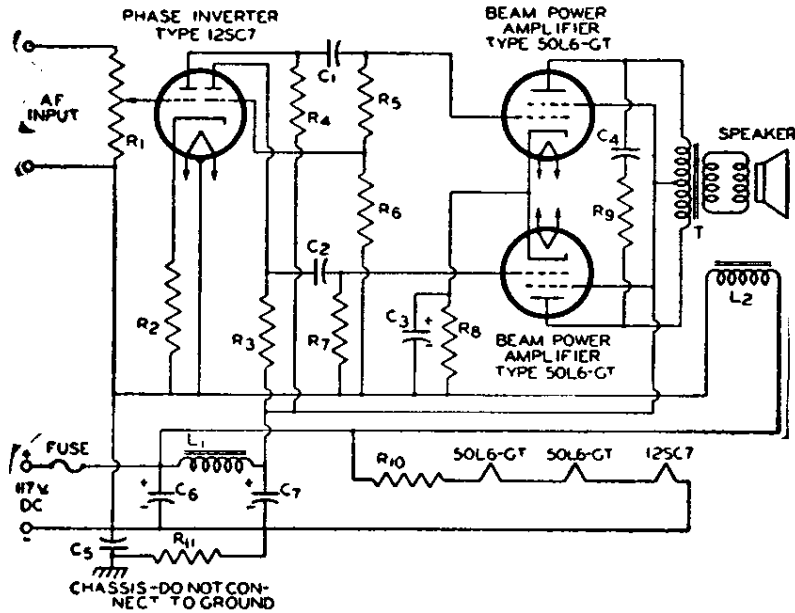

- C₁ C₂ = 0.006 μf
- C₃ = 25 μf, electrolytic, 25 v.
- C₄ = 0.035 μf
- C₅ = 0.1 μf, paper, 150 v.
- C₆ = 2 μf, electrolytic, 150 v.
- C₇ = 4 μf, electrolytic, 150 v.
- L₁ = Filter choke, 10 henries at 125 ma., 60 ohms

- L₂ = Speaker field, 115 volts dc
- R₁ = Volume control, potentiometer, 500000 ohms
- R₂ = 4000 ohms, 0.5 watt
- R₃ R₄ R₁₁ = 250000 ohms, 0.5 watt
- R₅ = 475000 ohms, 0.5 watt
- R₆ = 16000 ohms, 0.5 watt

- R₇ = 500000 ohms, 0.5 watt
- R₈ = 70 ohms, 1 watt
- R₉ = 4000 ohms, 2 watts
- R₁₀ = 33 ohms, 1.0 watt
- T = Output transformer for matching the impedance of voice coil to 3000-ohm plate-to-plate tube load

* Signal voltage input for full power output = 0.25 volt peak

(15-13)

TWO-CHANNEL AUDIO MIXER

Voltage Gain From Each Grid of 6SC7 to Output is Approximately 15

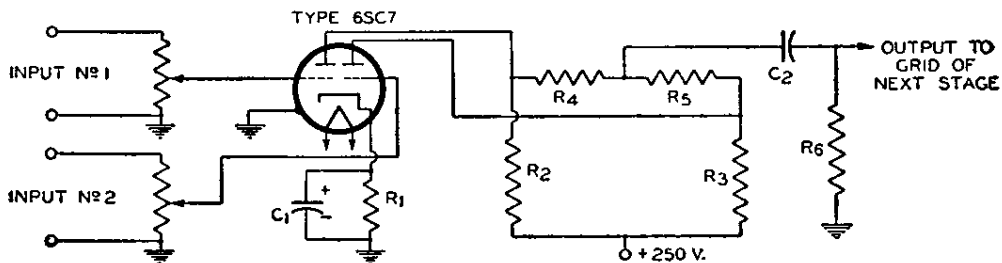

- C₁ = 8 μf, electrolytic, 25 v.
- C₂ = 0.005 μf, paper, 400 v.

- R₁ = 2000 ohms, 0.5 watt

- R₂ R₃ = 250000 ohms, 0.5 watt
- R₄ R₅ R₆ = 1 megohm, 0.5 watt

(15-14)

NON-MOTORBOATING RESISTANCE-COUPLED AMPLIFIER

Voltage Gain, 9000

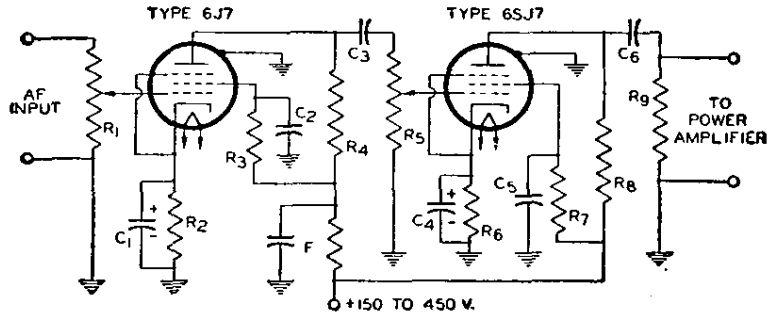

C₁ C₄ = 8 μ f, electrolytic, 25 v.
 C₂ C₅ = 0.06 μ f, voltage rating
 as high as voltage supply
 C₃ C₆ = 0.006 μ f, voltage rating
 as high as voltage supply

R₁ = Volume control, potentiometer
 R₂ R₆ = 600 ohms, 0.5 watt
 R₃ R₇ R₉ = 500000 ohms, 0.5 watt

R₄ R₈ = 100000 ohms, 0.5 watt
 R₅ = Volume control, potentiometer, 0.5 megohm, ganged with R₁
 F = Decoupling filter

NOTE: Values of resistance and capacitance shown in this circuit are taken from Charts 14 and 20 in the RESISTANCE-COUPLED AMPLIFIER SECTION. The values are chosen to give a sharp low-frequency cutoff and, thus, to minimize tendency of multiple stages to motorboat. Three or more stages, including power stage, operated from a common B-supply may require a decoupling filter in the plate-supply lead of one or more of the voltage amplifier stages. The constants of decoupling filters depend on the design requirements of the amplifier.

(15-15)

CODE PRACTICE OSCILLATOR

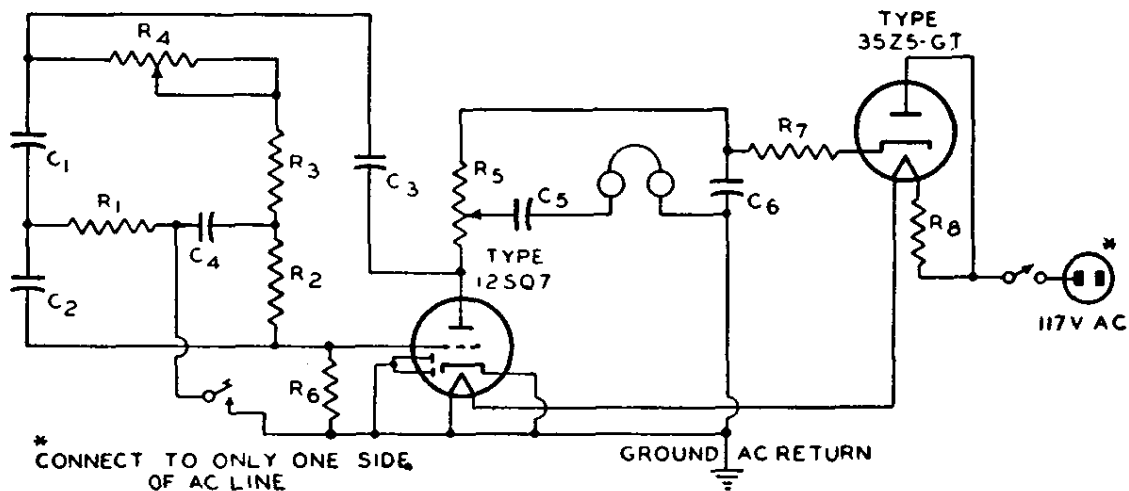

C₁ C₂ = 0.001 μ f, mica, 300 v.
 C₃ = 0.01 μ f, paper, 400 v.
 C₄ = 0.002 μ f, mica, 300 v.
 C₅ = 0.003 μ f, paper, 400 v.
 C₆ = 20 μ f, electrolytic, 250 v.

R₁ = 27000 ohms, 0.5 watt
 R₂ = 0.27 megohm, 0.5 watt
 R₃ = 0.22 megohm, 0.5 watt
 R₄ = Potentiometer, 1.0 megohm, carbon

R₅ = Volume control, potentiometer, 0.1 megohm
 R₆ = 2.2 megohms, 0.5 watt
 R₇ = 47000 ohms, 0.5 watt
 R₈ = 470 ohms, 25 watts

(15-16)

AF VOLTAGE AMPLIFIER WITH SIGNAL MIXER, MASTER MIXER AND COMPRESSOR-EXPANDER

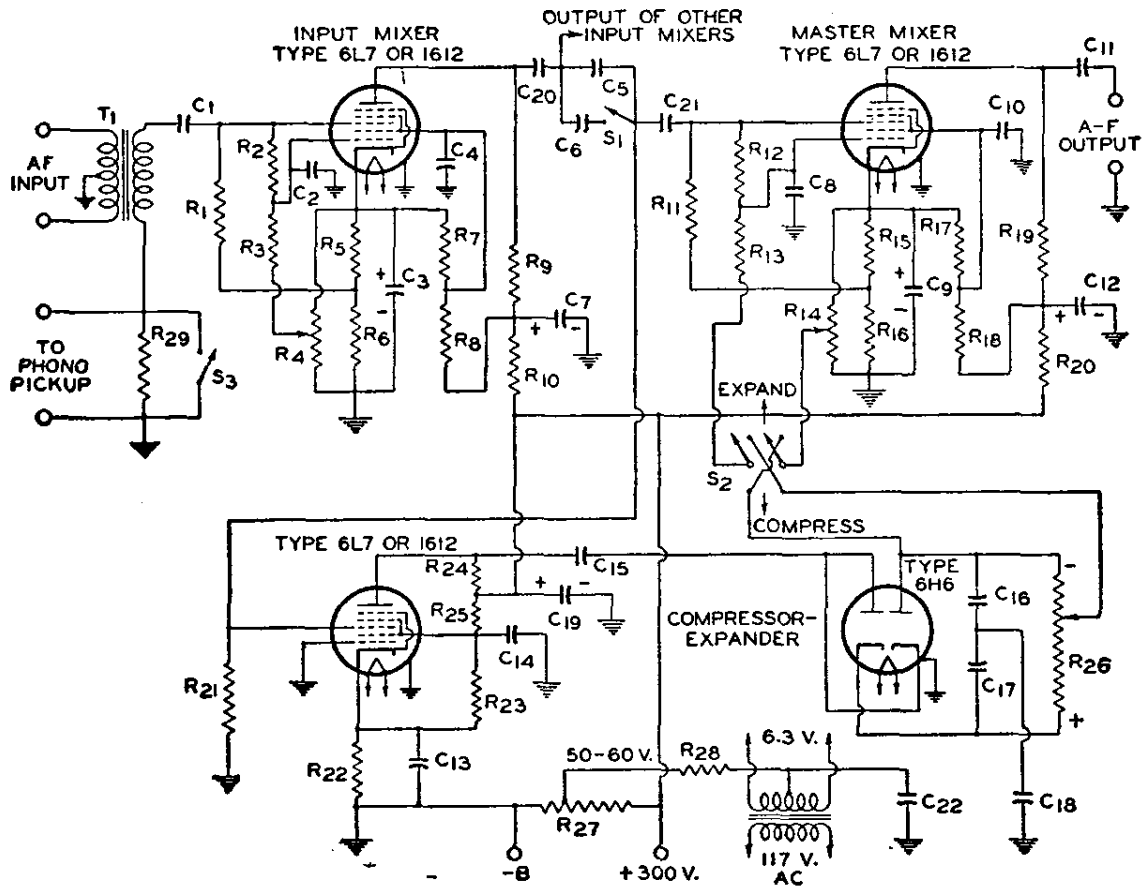

C₁ C₄ C₆ C₁₀ C₁₁ C₁₄ C₁₅ C₁₆ C₁₇
 C₁₈ C₂₀ C₂₁ = 0.05 μf
 C₂ C₈ = 0.25 μf
 C₃ C₇ C₉ C₁₂ = 8 μf
 C₅ = 0.0015 μf
 C₁₃ = 0.5 μf
 C₁₉ = 4 μf
 C₂₂ = 0.1 μf
 R₁ = 50000 ohms, 0.5 watt
 R₂ R₁₂ = 1.2 megohms, 0.5 watt
 R₃ R₁₃ = 820000 ohms, 0.5 watt
 R₄ R₁₄ = Potentiometers,
 250000 ohms

R₅ R₁₅ = 1000 ohms, 0.5 watt
 R₆ R₇ R₁₆ R₁₇ = 30000 ohms,
 0.5 watt
 R₈ R₁₈ = 150000 ohms, 1 watt
 R₉ R₁₉ R₂₄ = 300000 ohms, 0.5
 watt
 R₁₀ R₂₀ = 50000 ohms, 0.5 watt
 R₁₁ R₂₅ = 100000 ohms, 0.5
 watt
 R₂₁ = 150000 ohms, 0.5 watt
 R₂₂ = 500 ohms, 0.5 watt
 R₂₃ = 40000 ohms, 0.5 watt
 R₂₈ = Potentiometer, 1 megohm

R₂₇ = Bleeder resistor, tapped
 at 50 to 60 volts to provide
 heater-circuit bias
 R₂₈ = 100000 ohms, 0.5 watt
 R₂₉ = 5000 ohms, 0.5 watt
 S₁ = Switch, music-speech,
 single-pole, single-throw
 S₂ = Switch, expand-compress,
 double-pole, double-throw
 S₃ = Switch, phonograph; close
 when phonograph is not in
 use
 T₁ = Transformer, microphone
 input

NOTE 1: Potentiometer R₄ controls the bias on grid No.1 of the input mixer stage and thus controls the gain of this stage. When the contact is at the cathode end of R₄, gain is at maximum. Because the leads to R₄ do not carry af voltage, R₄ can be connected to the circuit through a long cable for remote control. Potentiometer R₁₄ controls the no-signal gain of the master mixer stage. When the circuit is to be used as a volume expander, the contact should be set at the ground end of R₁₄; when it is to be used as a compressor, the contact should be set at the cathode end of R₁₄. The degree of expansion or compression can be controlled by R₂₈. Maximum expansion or compression is obtained with the contact at the positive end. R₁₄ and R₂₈ can also be connected to the circuit through cables for remote control.

NOTE 2: Volume expander circuits are discussed on pages 27 and 28 of the ELECTRON TUBE APPLICATIONS SECTION.

(15-17)

MICROPHONE AND PHONOGRAPH AMPLIFIER
 With Phase Inverter and Vacuum-Tube Mixer*
 Power Output, 10 Watts

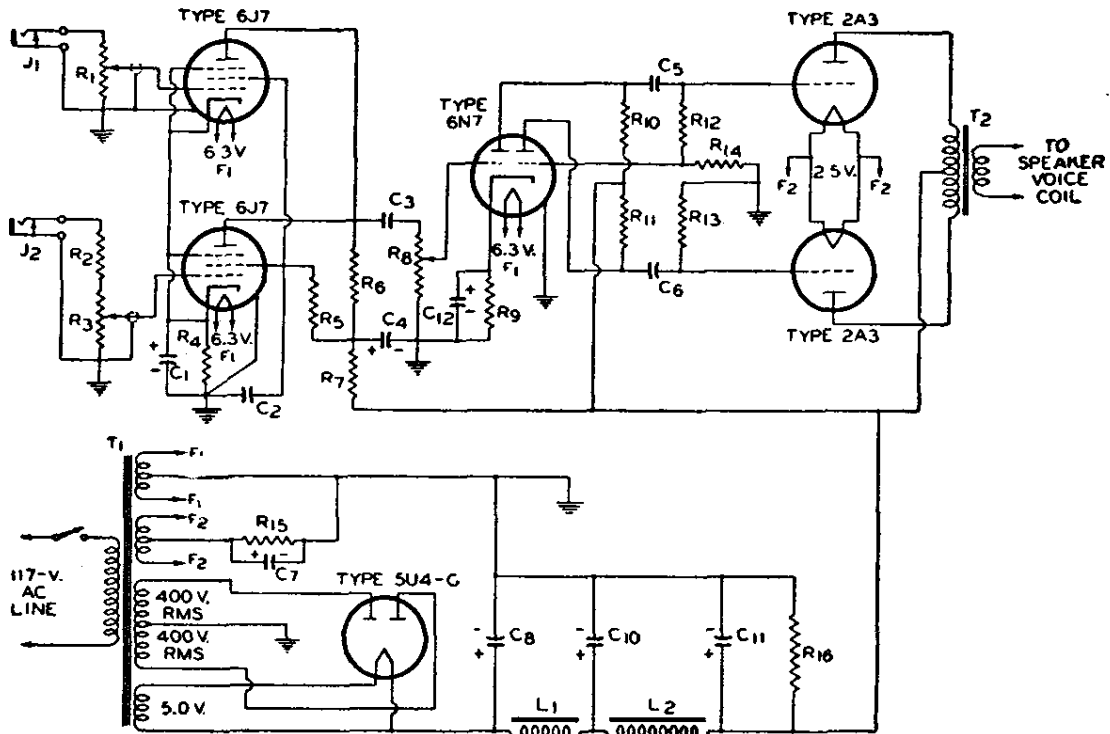

$C_1 = 10 \mu f$, electrolytic, 25v.
 $C_2 = 0.1 \mu f$, paper, 400 v.
 $C_3 = 0.005 \mu f$, paper, 600 v.
 $C_4 C_{11} = 8 \mu f$, electrolytic, 450 v.
 $C_5 C_6 = 0.01 \mu f$, paper, 600 v.
 $C_7 = 50 \mu f$, electrolytic, 100 v.
 $C_8 = 16 \mu f$, electrolytic, 600 v.
 $C_{10} = 8 \mu f$, electrolytic, 475 v.
 $C_{12} = 25 \mu f$, electrolytic, 25 v.
 $J_1 =$ Jack for high-impedance crystal microphone input, 0.023 volt peak
 $J_2 =$ Jack for high-impedance

crystal phono-pickup input, 0.6 volt peak
 $L_1 =$ Filter choke, 12 henries, 120 ohms, 100 ma.
 $L_2 =$ Speaker field, 1000 ohms, 10 watts
 $R_1 =$ Potentiometer, 1 megohm
 $R_2 = 0.5$ megohm, 0.5 watt
 $R_3 =$ Potentiometer, 20000 ohms
 $R_4 = 800$ ohms, 0.5 watt
 $R_5 = 1.2$ megohms, 0.5 watt
 $R_6 = 0.25$ megohm, 0.5 watt
 $R_7 = 50000$ ohms, 0.5 watt

$R_8 =$ Volume control, potentiometer, 1 megohm
 $R_9 = 1500$ ohms, 0.5 watt
 $R_{10} R_{11} = 0.1$ megohm, 0.5 watt
 $R_{12} R_{13} = 0.27$ megohm, 0.5 watt
 $R_{14} = 12000$ ohms, 0.5 watt
 $R_{15} = 780$ ohms, 10 watts
 $R_{16} = 20000$ ohms, 15 watts
 $T_1 =$ Power transformer, 400-0-400 v. RMS, 100 ma.
 $T_2 =$ Output transformer for matching impedance of voice coil to 5000-ohm plate-to-plate tube load

* Voltage gain of microphone channel up to 2A3 grid is better than 2700.

(15-18)

INTERCOMMUNICATION SET
With Master Unit and Six Remote Units

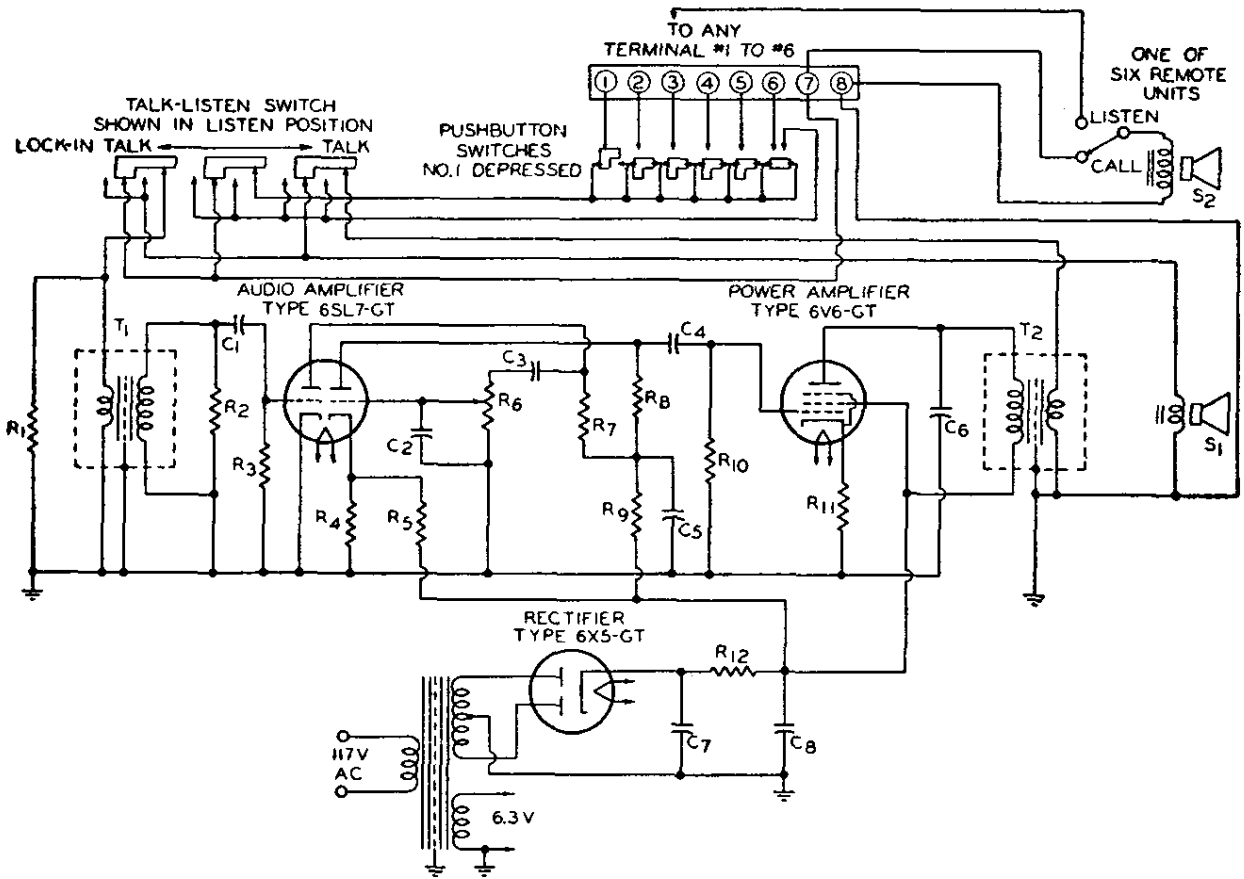

$C_1 = 0.0025 \mu f, 400 \text{ v.}$
 $C_2 = 470 \mu f, 500 \text{ v.}$
 $C_3 = 330 \mu f, 500 \text{ v.}$
 $C_4 = 0.01 \mu f, 600 \text{ v.}$
 $C_5 = 0.1 \mu f, 400 \text{ v.}$
 $C_6 = 5600 \mu f, 500 \text{ v.}$
 $C_7, C_8 = 20 \mu f, 350 \text{ v.}$
 $R_1 = 12 \text{ ohms, } 0.5 \text{ watt}$
 $R_2 = 0.47 \text{ megohm, } 0.5 \text{ watt}$

$R_3 = 10 \text{ megohms, } 0.5 \text{ watt}$
 $R_4 = 330 \text{ ohms, } 0.5 \text{ watt}$
 $R_5 = 56000 \text{ ohms, } 0.5 \text{ watt}$
 $R_6 = \text{Volume control, potentiometer, } 0.5 \text{ megohm}$
 $R_7, R_8, R_{10} = 0.33 \text{ megohm, } 0.5 \text{ watt}$
 $R_9 = 82000 \text{ ohms, } 0.5 \text{ watt}$
 $R_{11} = 270 \text{ ohms, } 0.5 \text{ watt}$

$R_{12} = 470 \text{ ohms, } 2 \text{ watts}$
 $S_1, S_2 = \text{Speakers, permanent-magnet}$
 $T_1 = \text{Input transformer, primary to secondary turns ratio } 1:47.5$
 $T_2 = \text{Output transformer for matching impedance of voice coil to } 5000\text{-ohm tube load}$

(15-19)

ELECTRONIC VOLT-OHM METER

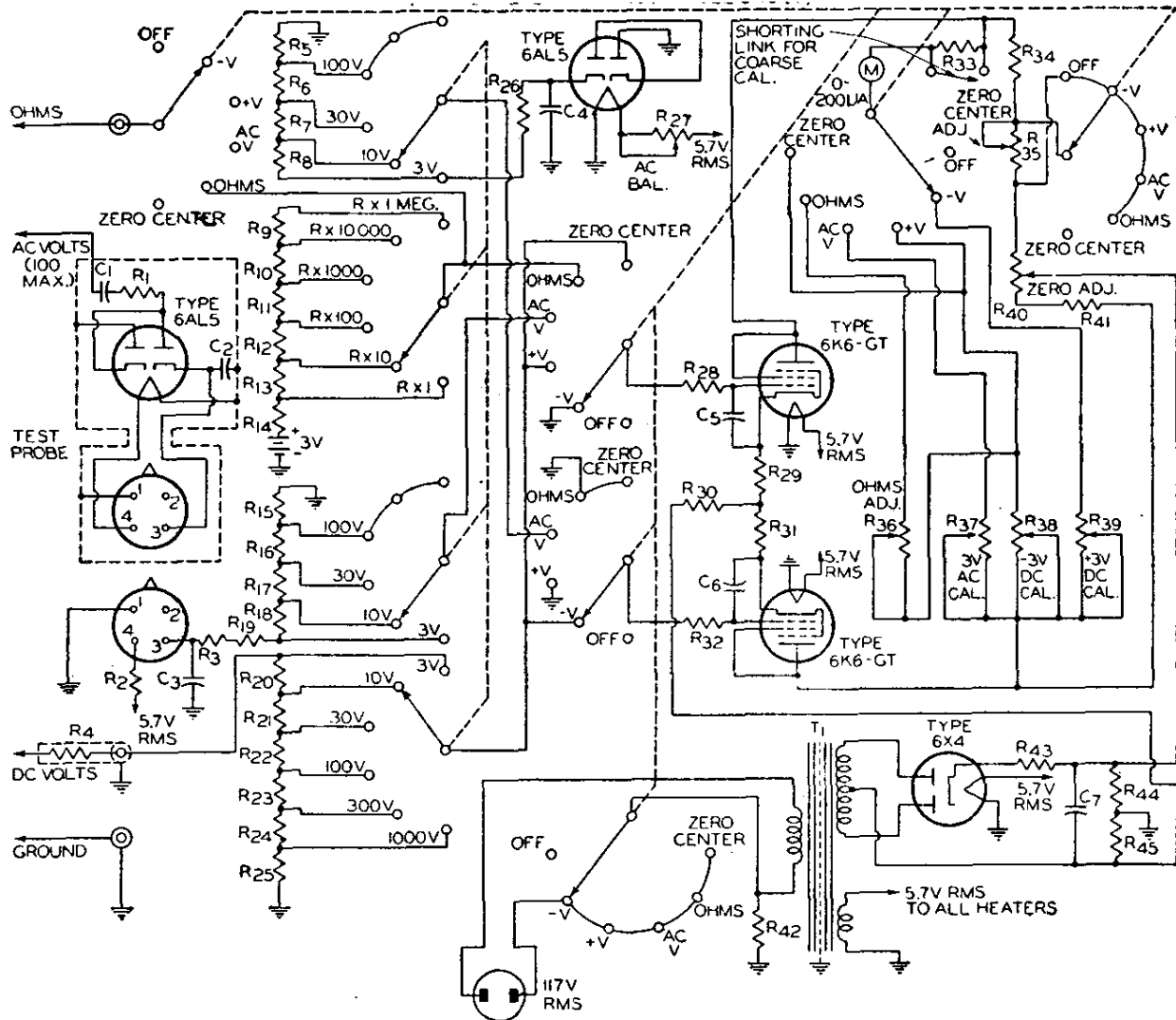

C₁ C₃ = 0.05 μf, oil-filled, 600 v.
 C₂ = 47 μf, ceramic
 C₄ C₅ C₆ = 3300 μf, mica
 C₇ = 0.25 μf, tubular, 400 v.
 R₁ = 82 ohms, 0.5 watt
 R₂ = 2.4 ohms, 1 watt
 R₃ R₁₉ = 3.9 megohms, 0.5 watt
 R₄ = 1 megohm, 0.5 watt
 R₅ = 0.12 megohm, 0.5 watt
 R₆ = 0.27 megohm, 0.5 watt
 R₇ = 0.91 megohm, 0.5 watt
 R₈ = 3.3 megohms, 0.5 watt
 R₉ = 9.9 megohms ± 1%, 0.5 watt
 R₁₀ = 90000 ohms ± 1%, 0.5 watt
 R₁₁ = 9000 ohms ± 1%, 0.5 watt
 R₁₂ = 900 ohms ± 1%, 0.5 watt
 R₁₃ = 90 ohms ± 1%, 0.5 watt
 R₁₄ = 9.5 ohms ± 1%, 0.5 watt

R₁₅ = 0.121 megohm ± 1%, 0.5 watt
 R₁₆ = 0.290 megohm ± 1%, 0.5 watt
 R₁₇ = 0.830 megohm ± 1%, 0.5 watt
 R₁₈ = 3.12 megohms ± 1%, 0.5 watt
 R₂₀ = 7 megohms (two 3.5-megohm ± 1%, 2-watt resistors in series)
 R₂₁ = 2 megohms ± 1%, 1 watt
 R₂₂ = 0.70 megohm ± 1%, 0.5 watt
 R₂₃ = 0.20 megohm ± 1%, 0.5 watt
 R₂₄ = 70000 ohms ± 1%, 0.5 watt
 R₂₅ = 30000 ohms ± 1%, 0.5 watt

R₂₆ = 8.2 megohms, 0.5 watt
 R₂₇ = Potentiometer, 20 ohms, 5 watts
 R₂₈ R₃₂ = 3.3 megohms, 0.5 watt
 R₂₉ R₃₁ = 3000 ohms, 0.5 watt
 R₃₀ = 39000 ohms, 0.5 watt
 R₃₃ = 3300 ohms, 0.5 watt
 R₃₄ R₄₁ = 18000 ohms, 0.5 watt
 R₃₅ = Potentiometer, 30000 ohms, 2 watts
 R₃₆ R₄₀ = Potentiometers, 7000 ohms, 2 watts
 R₃₇ R₃₈ R₃₉ = Potentiometers, 8000 ohms, 2 watts
 R₄₂ = 5.6 megohms, 1 watt
 R₄₃ = 6200 ohms, 0.5 watt
 R₄₄ = 15000 ohms, 0.5 watt
 R₄₅ = 20000 ohms, 0.5 watt
 T₁ = Power transformer, 100-0-100 volts RMS, dc load current less than 5 ma.

Outlines

METAL TUBES—Outlines 1-7

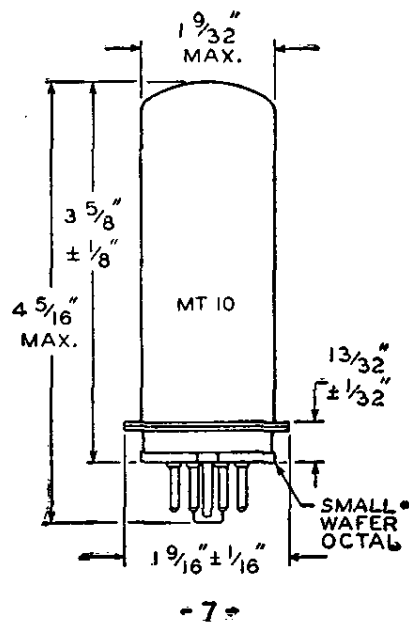
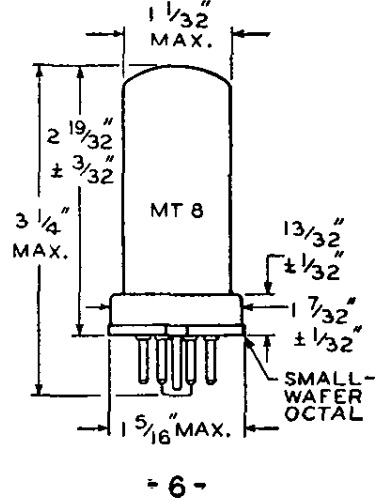
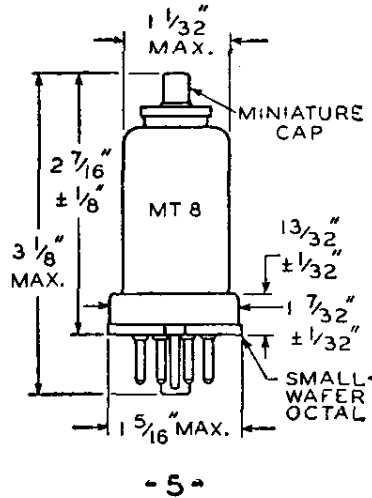
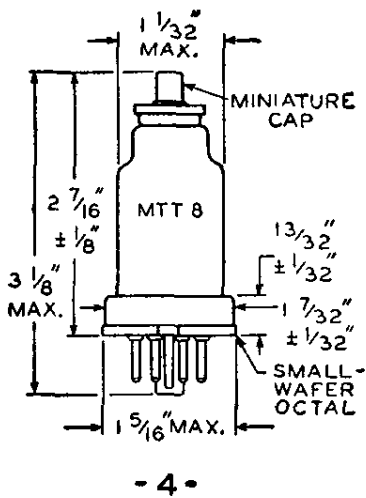
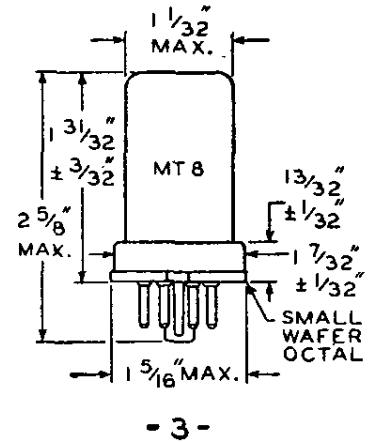
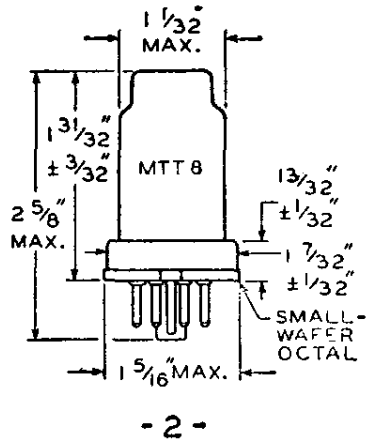
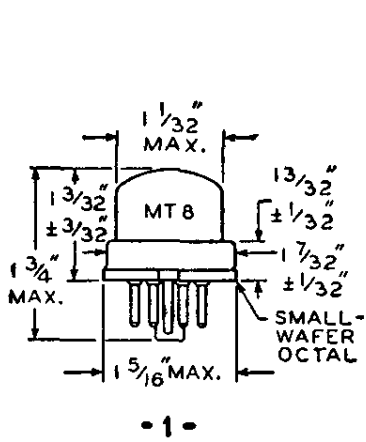

GLASS TUBES—Outlines 8-19

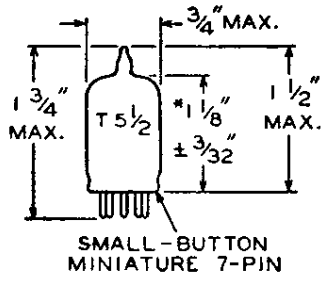

-8-

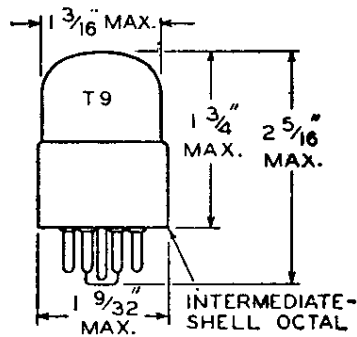

-9-

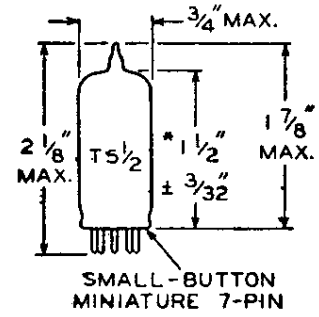

-10-

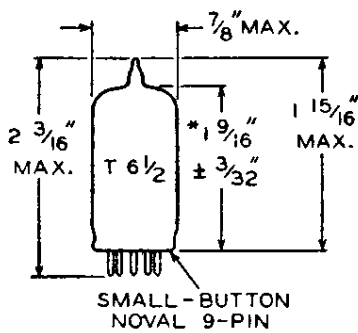

-11-

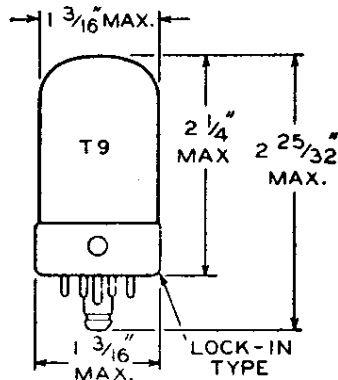

-12-

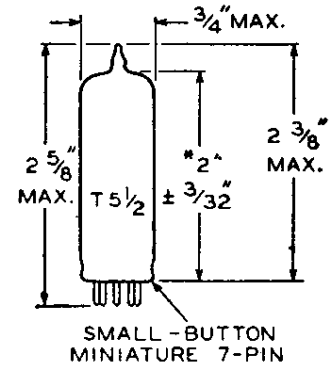

-13-

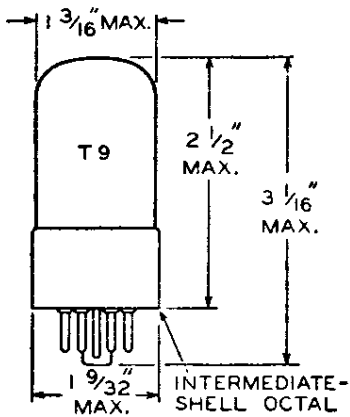

-14-

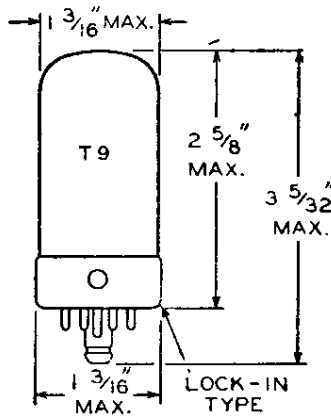

-15-

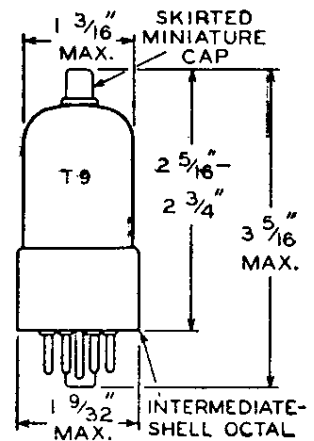

-16-

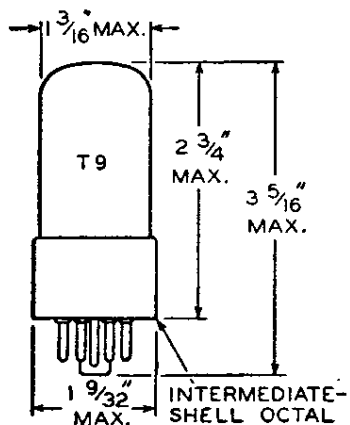

-17-

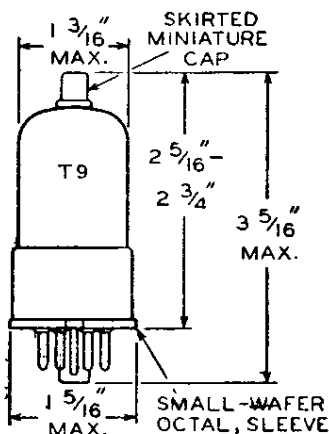

-18-

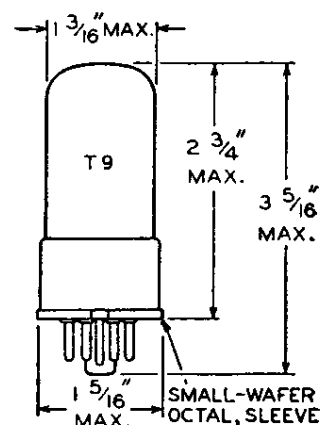

-19-

*MEASURED FROM BASE SEAT TO BULB-TOP LINE AS DETERMINED BY RING GAUGE OF 7/16" I.D.

GLASS TUBES—Outlines 20-28

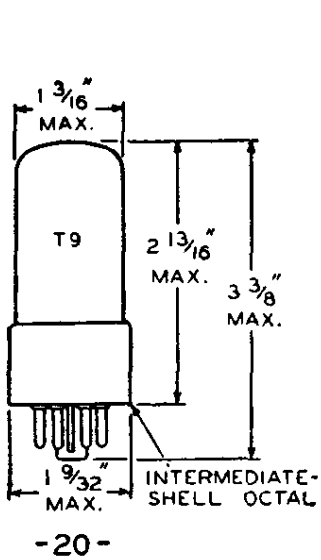

-20-

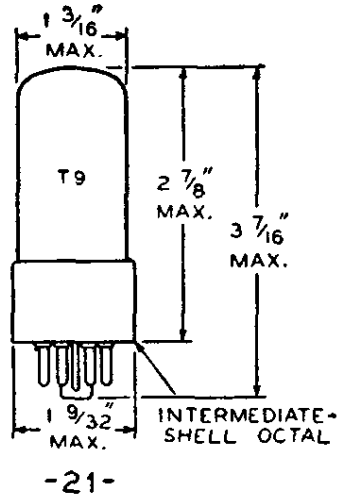

-21-

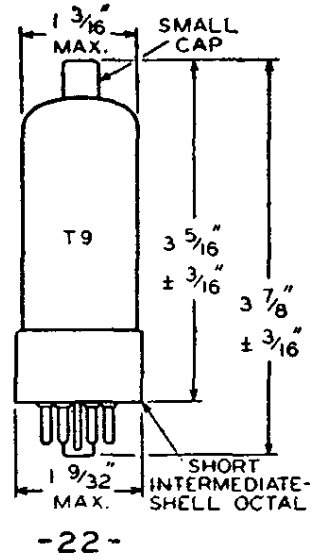

-22-

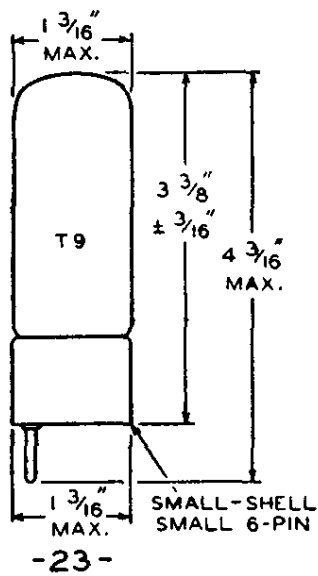

-23-

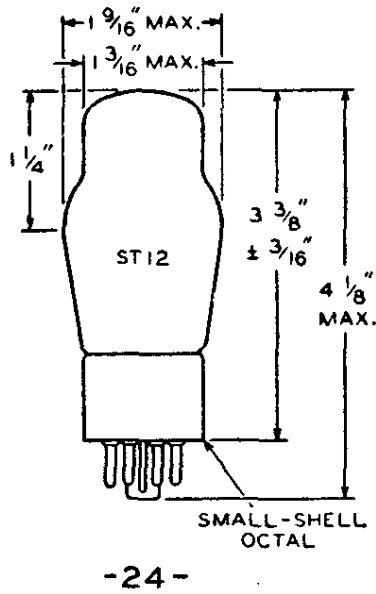

-24-

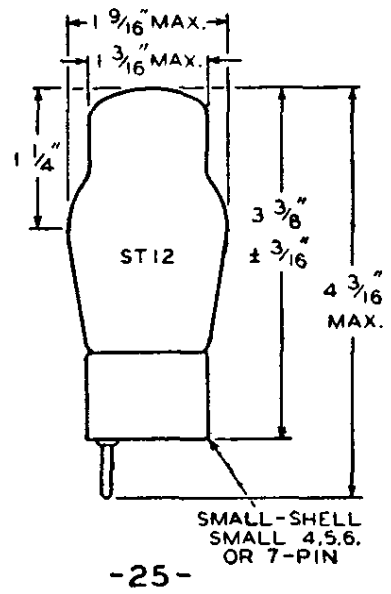

-25-

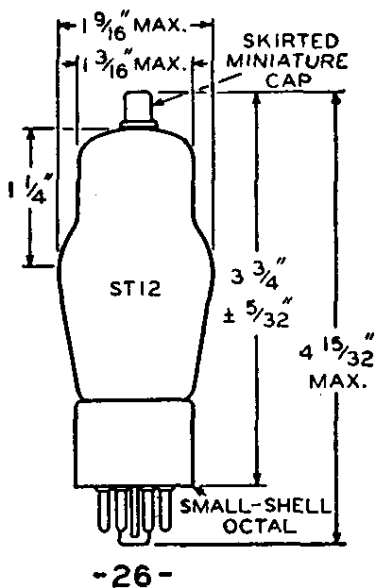

-26-

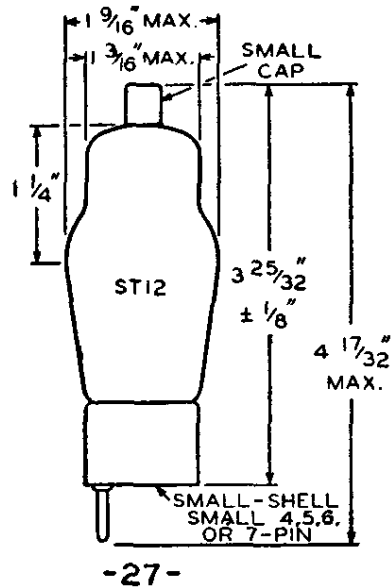

-27-

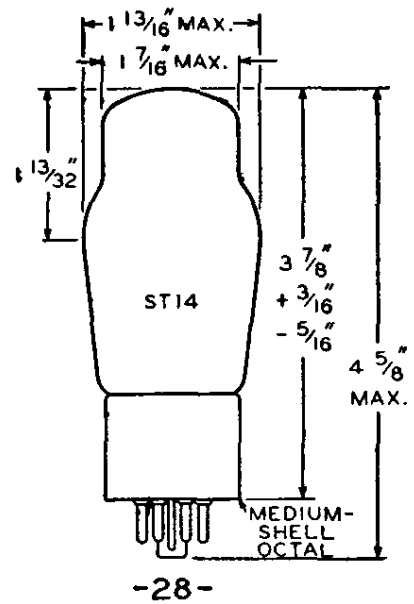

-28-

GLASS TUBES—Outlines 29-36

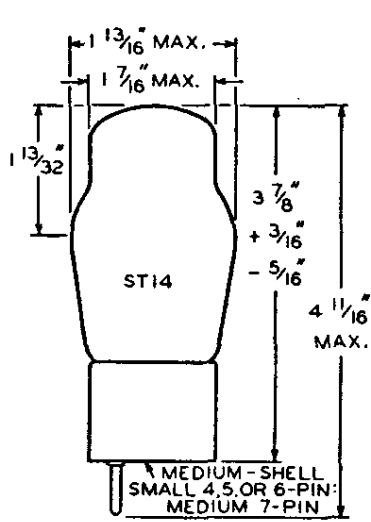

-29-

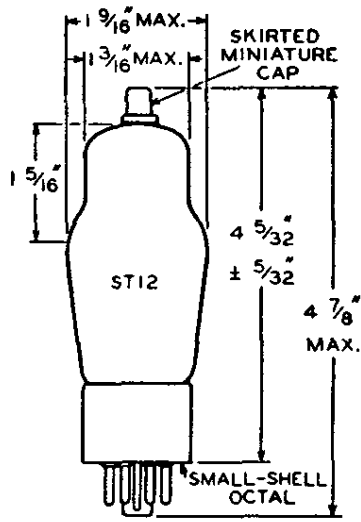

-30-

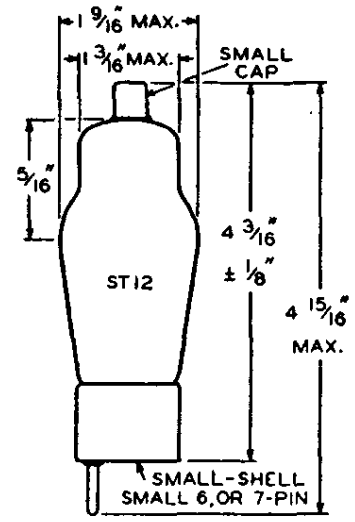

-31-

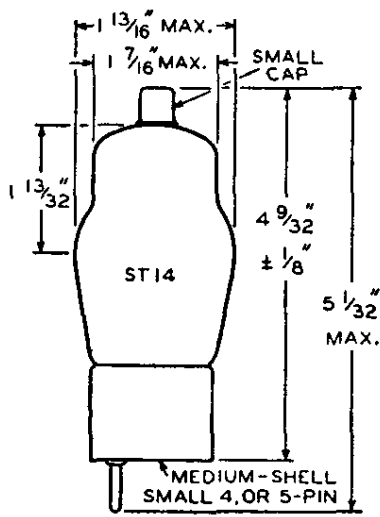

-32-

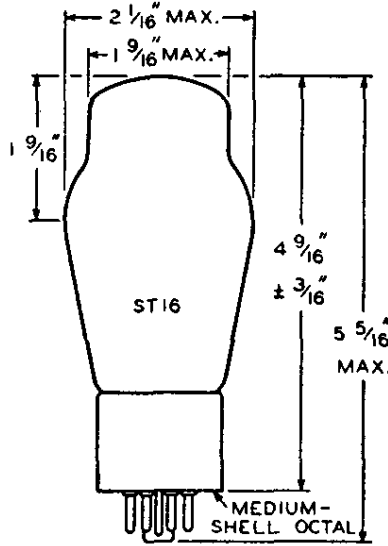

-33-

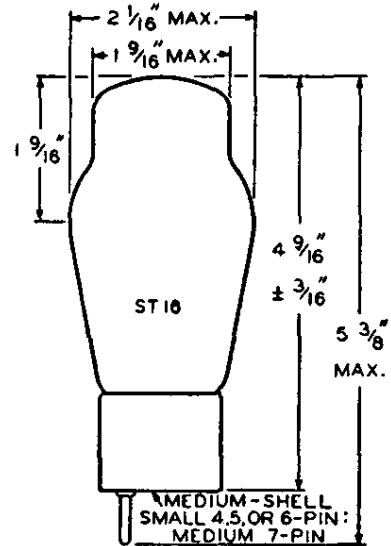

-34-

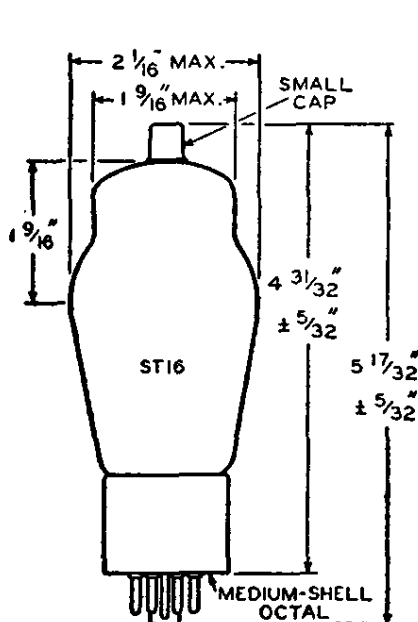

-35-

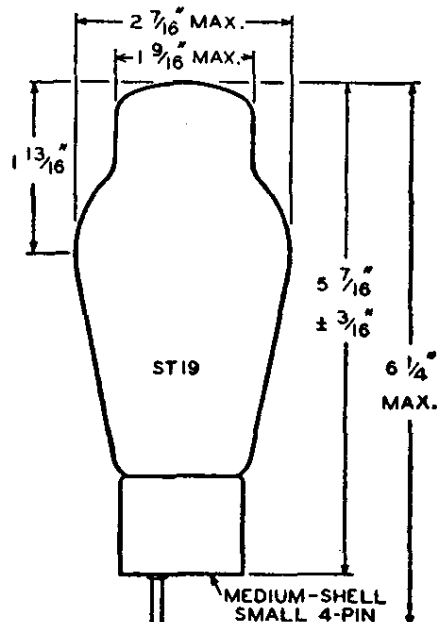

-36-

GLASS TYPES—Outline 37

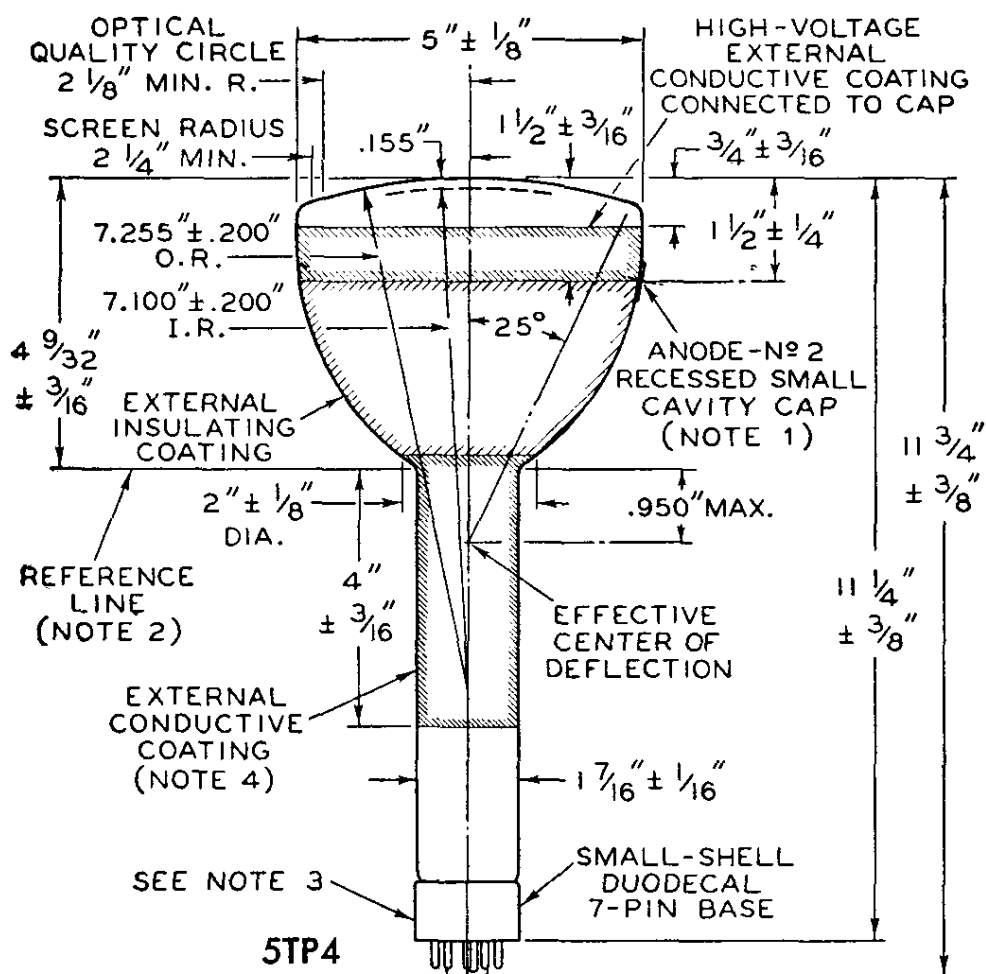

NOTE 1: The plane through the tube axis and vacant pin position No.3 may vary from the plane through the tube axis and anode-No.2 terminal by an angular tolerance (measured about the tube axis) of 10°. Anode-No.2 terminal is on same side as vacant pin position No.3.

NOTE 2: Reference line is determined by position where hinged gauge 1.500" + .003" — .000" I.D. and 2" long will rest on bulb cone.

NOTE 3: Socket for this base should not be rigidly mounted; it should have flexible leads and be allowed to move freely.

NOTE 4: External conductive coating must be grounded.

GLASS TYPES—Outline 38

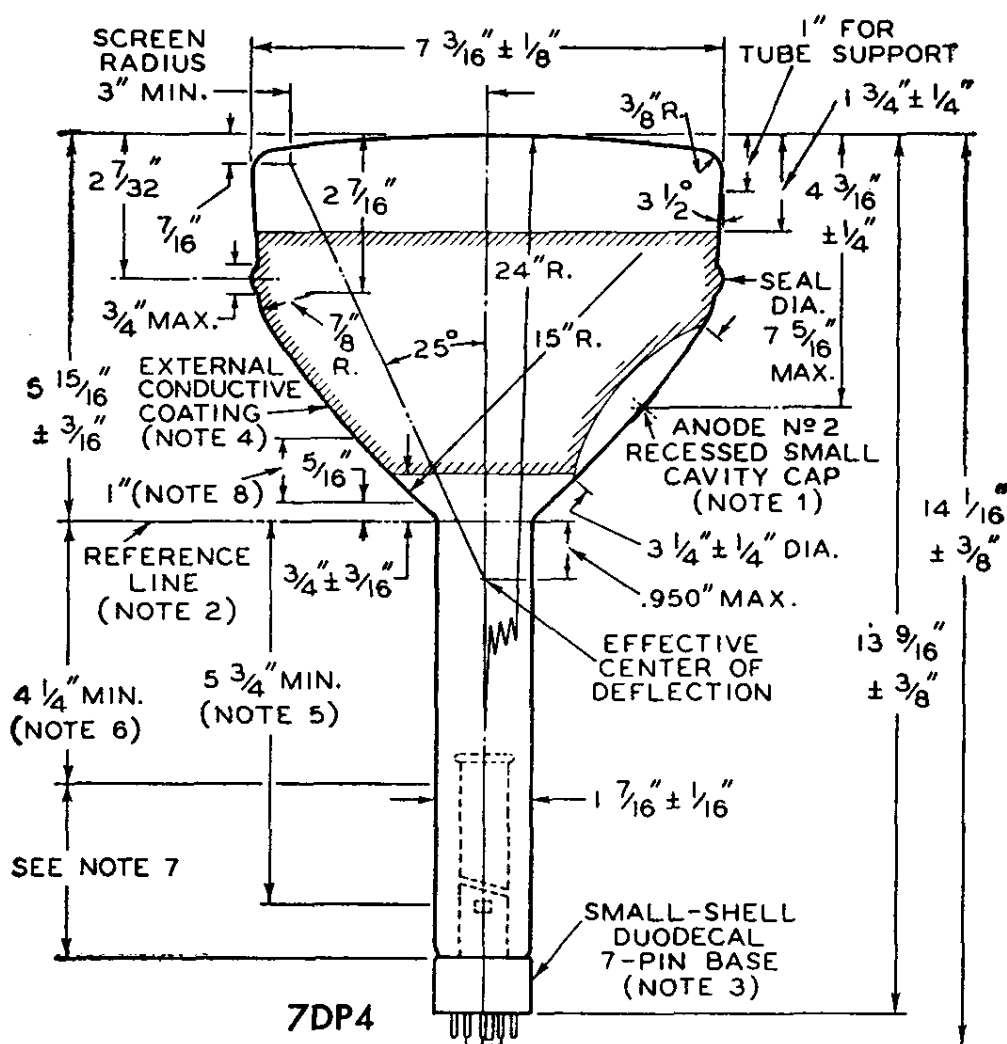

NOTE 1: The plane through the tube axis and vacant pin position No.3 may vary from the plane through the tube axis and anode-No.2 terminal by an angular tolerance (measured about the tube axis) of 10°. Anode-No.2 terminal is on same side as vacant pin position No.3.

NOTE 2: Reference line is determined by position where hinged gauge 1.500"±.003"—.000" I.D. and 2" long will rest on bulb cone.

NOTE 3: Socket for this base should not be rigidly mounted; it should have flexible leads and be allowed to move freely. Bottom circumference of base shell will fall within 1 7/8"-diameter circle concentric with bulb axis.

NOTE 4: External conductive coating must be grounded.

NOTE 5: Distance to internal pole pieces. Plane through pin No.6 and tube axis passes through line joining centers of pole pieces. Direction of principal field of ion-trap magnet should be such that north pole is adjacent to pin No.6 and south pole to pin No.12.

NOTE 6: Location of deflecting yoke must be within this space.

NOTE 7: Keep this space clear for ion-trap magnet.

NOTE 8: For tube support which must not cover specified clear area around anode cap.

GLASS TYPES—Outline 39

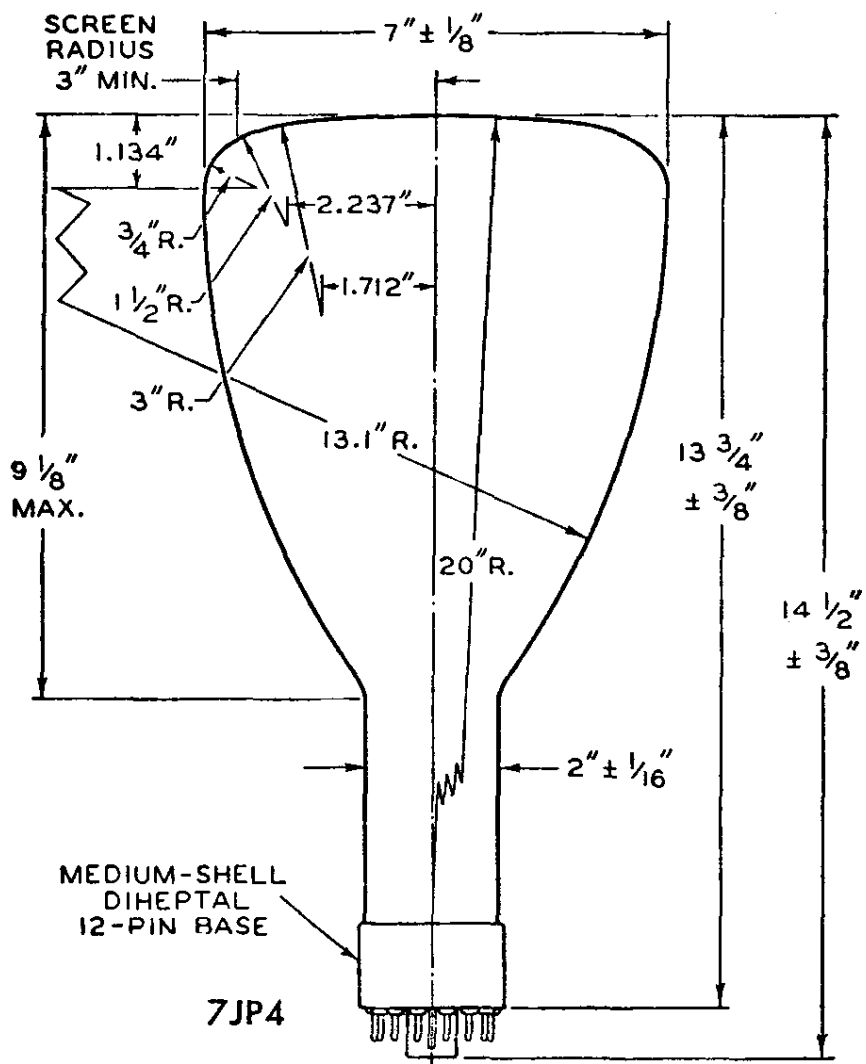

Center line of bulb will not deviate more than 2° in any direction from the perpendicular erected at the center of bottom of the base.

The plane through the tube axis and pin No.5 may vary from the trace produced by DJ1 and DJ2 by an angular tolerance (measured about the tube axis) of 10° . Angle between DJ1—DJ2 trace and DJ3—DJ4 trace is $90^\circ \pm 3^\circ$.

DJ1 and DJ2 are nearer the screen; DJ3 and DJ4 are nearer the base. With DJ1 positive with respect to DJ2, the spot will be deflected toward pin No.5; likewise, with DJ3 positive with respect to DJ4, the spot will be deflected toward pin No.2.

GLASS TYPES—Outline 40

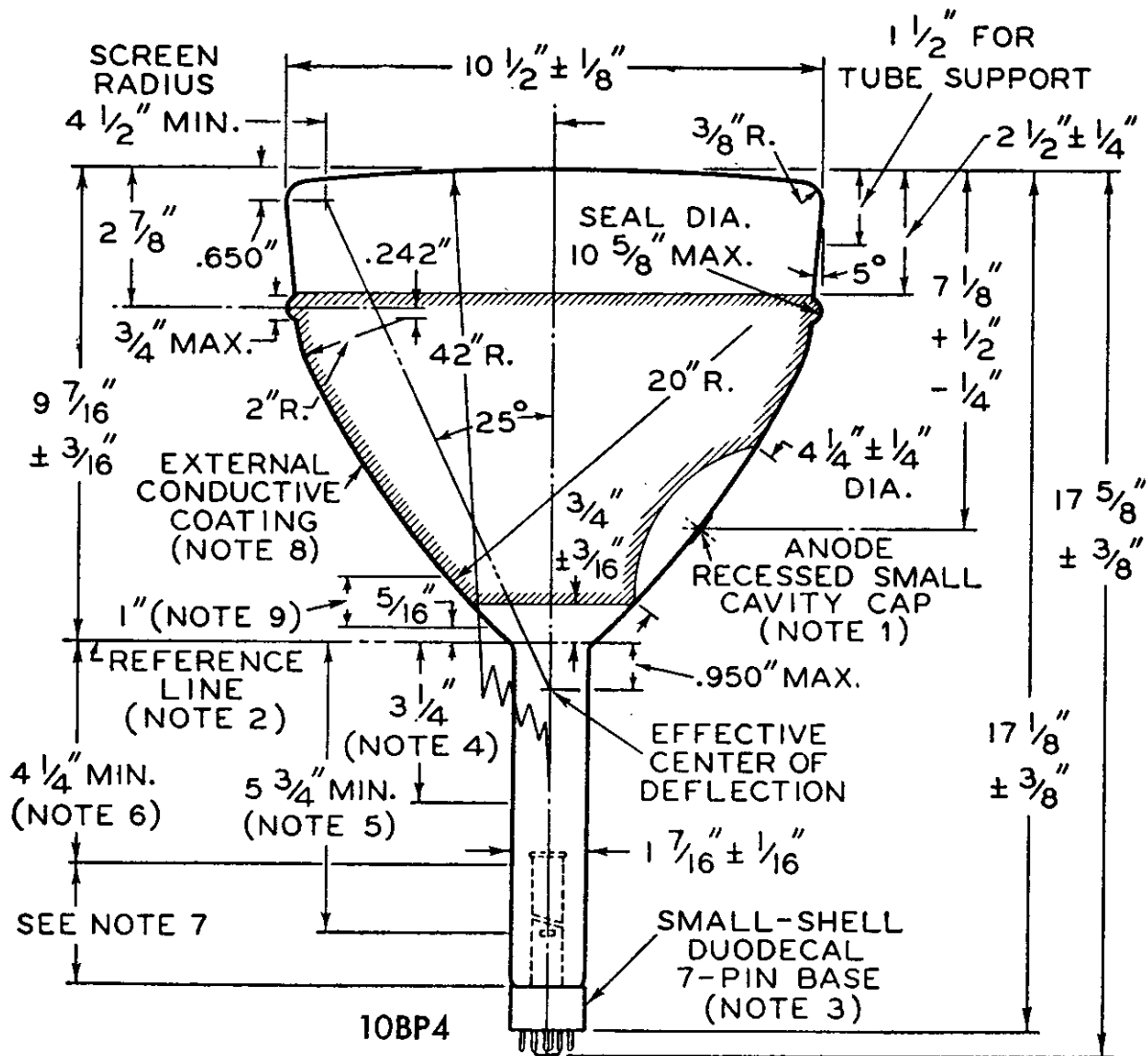

- NOTE: 1: The plane through the tube axis and vacant pin position No.3 may vary from the plane through the tube axis and anode terminal by an angular tolerance (measured about the tube axis) of 10°. Anode terminal is on same side as vacant pin position No.3.
- NOTE 2: Reference line is determined by position where hinged gauge 1.500" + .003" - .000" I.D. and 2" long will rest on bulb cone.
- NOTE 3: Socket for this base should not be rigidly mounted; it should have flexible leads and be allowed to move freely. Bottom circumference of base shell will fall within 1 7/8"-diameter circle concentric with bulb axis.
- NOTE 4: Approximate distance to center of focusing-coil air gap.
- NOTE 5: Distance to internal pole pieces. Plane through pin No.6 and tube axis passes through line joining centers of pole pieces. Direction of principal field of ion-trap magnet should be such that north pole is adjacent to pin No.6 and south pole to pin No.12.
- NOTE 6: Location of deflecting yoke and focusing-coil air gap must be within this space.
- NOTE 7: Keep this space clear for ion-trap magnet.
- NOTE 8: External conductive coating must be grounded.
- NOTE 9: For tube support which must not cover specified clear area around anode cap.

INDEX

	<i>Page</i>		<i>Page</i>
Admittance, Input	14	power sensitivity	12
Amplification Factor (μ)	11	transconductance	11
Amplifier:		voltage amplification (gain)	13
audio-frequency	13	Capacitor-Input Filter	50
audio mixer, circuit	223, 225	Cathode:	
class A	12, 13, 15	bias	47
class A ₁ , circuit	223, 224, 226	bypassing	48
class AB	12, 21	connection	46
class AB ₁	21	current	47
class AB ₁ , circuit	226	directly heated	4
class AB ₂	24	indirectly heated	4
class AB ₂ , circuit	222	resistor	47
class B	12, 24	types	3
class B, circuit	222	Characteristic Curves, Interpretation of ..	54
class C	12	Characteristics:	
dc	39	amplification factor	11
limiter	29, 36	control-grid-plate transconductance	11
parallel	16	conversion transconductance	11
phase-inverter	28	dynamic	10
push-pull	16, 18, 21, 24	plate resistance	11
radio-frequency	13, 15	static	10
remote-cutoff	14	Charts and Tables:	
sharp-cutoff	39	materials chart	210
voltage	13	miniature tube list	58
voltage-compressor circuit	225	outline drawings	229
volume-expander	27	preferred types list	Inside Back Cover
volume-expander, circuit	225	resistance-coupled amplifiers	194
Amplitude Modulation (AM)	31	structure of metal tube	189
Anode	5	structure of miniature tube	2
Anode-Grid	41	tube classification by use and by cathode	
Arc-Back Limit	53	voltage	56
Automatic Frequency Control (AFC)	43	types not recommended for new	
Automatic Volume Control (AVC)	37	equipment design	Inside Back Cover
Beam Power Tube Considerations	8	Choke-Input Filter	50
Bias:		Circuit Diagram of:	
battery	47	ac/dc superheterodyne receiver (15-4) ..	215
cathode (self)	47	ac-operated regenerative short-wave	
diode	33	receiver (15-8)	220
grid-resistor	34	ac-operated superheterodyne receiver	
self (cathode)	47	(15-3)	214
Calculation of:		af voltage amplifier with signal	
amplification factor	11	mixer, master mixer, and	
cathode (self-bias) resistor	47	compressor-expander (15-16)	225
control-grid-plate transconductance	11	audio mixer (15-13)	223
filament resistor power dissipation	45	automobile receiver (15-5)	216
filament (or heater) resistor value	44	battery-operated short-wave receiver	
harmonic distortion	17, 20, 23	(15-9)	221
load resistance	19, 20, 22	class A ₁ audio amplifier (15-12)	223
operating conditions from conversion		class B amplifier for mobile use (15-11) ..	222
curves	20	code practice oscillator (15-15)	224
peak inverse plate voltage	53	electronic volt-ohm meter (15-19)	228
plate efficiency	12	FM tuner (15-7)	218
plate resistance	11	high-power audio amplifier (15-10)	222
power output	17, 20, 22	intercommunication set (15-18)	227
		microphone and phonograph amplifier	
		(15-17)	226

INDEX (Continued)

	<i>Page</i>		<i>Page</i>
non-motorboating resistance-coupled		Emission:	
amplifier (15-14)	224	current	5
portable superheterodyne receiver (15-1)	212	secondary	8, 9
portable 3-way superheterodyne		test	191
receiver (15-2)	213	Feedback:	
superregenerative receiver (15-6)	217	inverse	24
Conversion Curves, Use of	20	undesired	50
Conversion Transconductance	11	Filament (also see Heater and Cathode):	
Corrective Filter	27	operation	3, 44
Cross-Modulation	15, 48	resistor	44
Current:		series operation	45
cathode	47	shunt resistor	45
dc output	53	supply voltage	44
grid	12, 21	Filter:	
peak plate	58	capacitor-input	50
plate	5	choke-input	50
Curves, Interpretation of Characteristic . .	54	corrective	27
Cutoff	14	radio-frequency	51
DC Amplifier	39	smoothing	51
Degeneration (See Inverse Feedback)		Formulas (see Calculation)	
Delayed Automatic Volume Control		Frequency Conversion	40
(DAVC)	38	Frequency Modulation (FM)	31, 34
Demodulation	32	Full-Wave Diode Detection	33
Design-Center System of Ratings	54	Full-Wave Rectifier	5, 29
Detection:		Fuses, use of	47
diode	32	Gain (Voltage Amplification)	13
discriminator	35	Grid:	
full-wave diode	33	anode	41
grid bias	34	bias	47
grid-resistor and capacitor	34	bias detection	34
ratio detector	36	considerations	6
Diode:		current	12, 21
biasing	33	resistor	14
considerations	5	resistor and capacitor detection	34
detection	32	voltage supply	47
load resistor	33	Grid-Plate Capacitance	7
Discriminator	35	Grid-Plate Transconductance	11
Dress of Circuit Leads	50	Half-Wave Rectifier	5, 29
Driver	16, 21, 24	Harmonic Distortion	17, 20, 23
Dynamic Characteristics	11	Heater:	
Electron:		cathode	4
considerations	3	cathode bias	47
secondary	8, 9	cathode connection	46
Electron Tube Applications	12	resistor	44
Electron Tube Characteristics	10	series operation	45
Electron Tube Installation	44	shunt resistor	45
Electron Tube Testing	190	supply voltage	44
Electrons, Electrodes, and Electron Tubes	3	Hexode Mixer	42
Electron-Ray Tubes	38	Impedance, Input	14
		Instantaneous Peak Voltage	51
		Interelectrode Capacitances	7

INDEX (Continued)

	<i>Page</i>		<i>Page</i>
Intermediate Frequency, production of...	41	Pentode Considerations.....	8
Interpretation of Tube Data.....	52	Phase Inverter.....	28, 196
Inverse Feedback:		Plate:	
constant-current type.....	25, 26	current.....	5
constant-voltage type.....	25	dissipation.....	52
Key to Socket Connection		efficiency.....	12
Diagrams.....	Inside Front Cover	load.....	19, 20, 22
Limiters.....	29	resistance.....	11
Load:		voltage supply.....	47
resistance.....	19, 20, 22	Plate-Cathode Capacitance.....	7
resistance line.....	16, 18, 19, 21	Power Output:	
Materials Chart.....	210	calculations.....	17, 20, 22
Metal Tube, Structure of.....	189	test.....	192
Mercury-Vapor Rectifier:		Power Sensitivity.....	12
considerations.....	6	Power Supply.....	47
interference from.....	51	Preferred Types List.....	Inside Back Cover
Mho.....	11	Push-Pull Operation.....	16, 18, 21, 24
Micromho.....	11	Radio-Frequency:	
Miniature Tube:		amplifier.....	13, 15
list.....	58	filter.....	51
structure of.....	2	Ratings, Design-Center System.....	54
Mixer:		Ratio Detector.....	36
audio.....	223, 225	Reading List.....	256
hexode.....	42	Receiving Tube Classification Chart.....	56
pentagrid.....	42	Rectifiers:	
Modulated Wave.....	31, 34	full-wave.....	5, 29
Modulation.....	31	half-wave.....	5, 29
Modulation-Distortion.....	15, 48	ionic-heated cathode.....	6
Multi-Electrode Tube.....	9	parallel operation of.....	30
Multi-Unit Tubes.....	9	voltage doubler.....	30
Multivibrator.....	40	Relaxation Oscillator.....	40
Mutual Conductance		Remote-Cutoff Tubes.....	14
(see Transconductance)		Resistance Coupling.....	13
Oscillator:		Resistance-Coupled Amplifier.....	26, 28, 194
considerations.....	40	Resistor:	
multivibrator.....	40	cathode (self-biasing).....	47
relaxation.....	40	center tap.....	47
Outlines of Tubes.....	229	filament.....	44
Output-Coupling Devices.....	52	filter.....	50
Parallel Operation.....	16	grid.....	14
Parasitic Oscillations.....	16	plate load.....	19, 20, 22
Peak Inverse Plate Voltage.....	53	screen.....	48
Peak Plate Current.....	53	Saturation Current.....	5
Pentagrid Converter.....	9, 41	Screen (Grid No. 2):	
Pentagrid Mixer.....	28, 42	considerations.....	7
		dissipation.....	52
		voltage supply.....	48
		Secondary Emission.....	8
		Secondary Electrons.....	8, 9

INDEX (Continued)

<i>Page</i>	<i>Page</i>
Self-bias (cathode bias).....	47
Shielding.....	49
Short-Circuit Test.....	190
Socket Connection Diagrams, Key to	Inside Front Cover
Space Charge.....	5, 9
Static Characteristics.....	10
Structure of a Metal Tube.....	189
Structure of a Miniature Tube.....	2
Suppressor (Grid No. 3).....	8
Symbols Used in Resistance-Coupled Amplifier Charts.....	195
Tables and Charts: (see Charts and Tables)	
Technical Data for Tube Types.....	59
Testing Electron Tubes.....	190
Tetrode Considerations.....	7
Transconductance: conversion.....	11
grid-plate.....	11
test.....	191
Triode Considerations.....	6
Tube: materials chart.....	210
outlines.....	229
ratings, interpretation of.....	52
structure of metal.....	189
structure of miniature.....	2
tester requirements.....	193
Tube Types:	
technical data.....	59
technical data supplement.....	241
Tuning Indicators.....	38
Twin Diode:	
pentode.....	10
triode.....	10, 33
Typical Operation Values, Interpretation of.....	54, 55
Voltage:	
amplification, class A.....	13
doubler rectifier.....	30
peak heater-cathode.....	53
peak inverse plate.....	53
supply.....	44
Voltage Conversion Factor.....	20
Voltage Doubler.....	30
Volume Control:	
automatic (AVC).....	37
by grid-voltage variation.....	48
by screen-voltage variation.....	49
delayed automatic (DAVC).....	38
Volume Expander.....	27, 225

Recently Added RCA Tube Types

This section contains technical descriptions of tubes that have been recently added to the RCA line. It includes both new types and older types which have applications in AM, FM, and television broadcast receivers.

HALF-WAVE GAS RECTIFIER

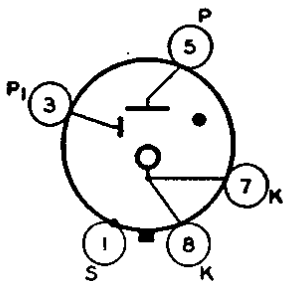

OY4

Metal type used primarily in vibrator-type B-supply units of automobile receivers. Utilizes a starter anode and an ionically heated cathode. Starter anode permits operation of OY4 directly from 117-volt ac line. Outline 3, OUTLINES SECTION. Tube requires octal socket. Pins 7 and 8 must be tied together at socket. RF filter circuits placed close to socket terminals are required to reduce rectifier noise. Ratings as

half-wave rectifier with capacitor-input filter: peak inverse anode volts, 300 *max*; peak anode ma., 500 *max*; dc output ma., 75 *max*, 40 *min*; series anode resistance (117-volt line operation), 50 *min* ohms; tube voltage drop (approx.), 12 volts; minimum ac starting voltage when starter anode is connected to anode through a 10-megohm resistor bypassed with a 0.002- μ f capacitor, 100 volts RMS. This type is used principally for renewal purposes.

REMOTE-CUTOFF PENTODE

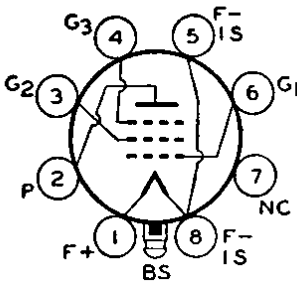

1LG5

Lock-in type used as rf or if amplifier in battery-operated receivers. Outline 12, OUTLINES SECTION. Tube requires lock-in socket. Filament volts (dc), 1.4; amperes, 0.05. Typical operation and maximum ratings as class A₁ amplifier: plate volts, 90 (110 *max*); grid-No.2 volts, 45 (110 *max*); grid-No.1 volts, 0; plate resistance (approx.), 1 megohm; transconductance, 800 μ mhos; plate ma., 1.7; grid-No.2 ma.,

0.4; grid-No.1 voltage for transconductance of 10 μ mhos, -10 volts.

GAS TRIODE

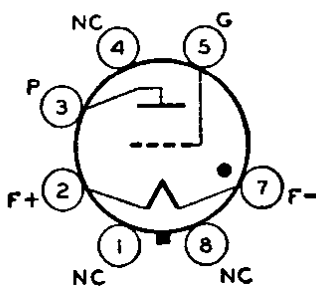

2A4-G

Glass octal type used in relay-control equipment such as motor-controlled tuning mechanisms of radio receivers. It is a grid-controlled gaseous-discharge tube. Outline 24, OUTLINES SECTION. Tube requires octal socket and may be mounted in any position. Filament volts (ac/dc), 2.5; amperes, 2.5. Filament voltage should be applied for 2 seconds before start of

tube conduction. Characteristics: peak inverse anode volts, 200 *max*; peak forward anode volts, 200 *max*; peak volts between any two electrodes, 250 *max*; peak anode amperes, 1.25 *max*; average anode amperes (over any 45-second period), 0.10 *max*; anode voltage drop, 15 volts. This type is used principally for renewal purposes.

FULL-WAVE VACUUM RECTIFIER

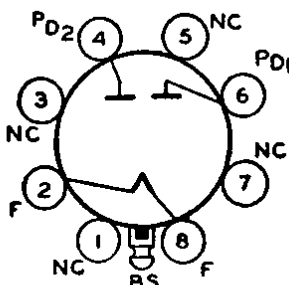

5AZ4

Lock-in type used in power supply of radio equipment having moderate dc requirements. Outline 15, OUTLINES SECTION. Tube requires lock-in socket. Filament volts, 5; amperes, 2. For maximum ratings, typical operation, and curves, refer to glass-octal type 5Y3-GT.

ELECTRON-RAY TUBE

6AL7-GT

Glass octal type used to indicate visually on a pair of rectangular fluorescent patterns the effects of changes in voltages applied to its grid and three deflecting electrodes. It is especially

useful in meeting the requirements for accurate tuning in FM receivers. Outline 14, OUTLINES SECTION. Tube requires octal socket. Heater volts (ac/dc), 6.3; amperes, 0.15.

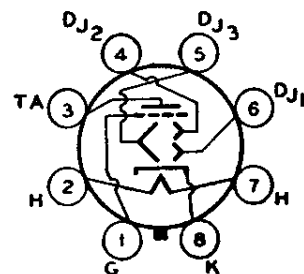

Maximum Ratings:

INDICATOR SERVICE

TARGET VOLTAGE.....	{ 365 max	volts
	{ 220 min	volts
PEAK HEATER-CATHODE VOLTAGE:		
Heater negative with respect to cathode.....	90 max	volts
Heater positive with respect to cathode.....	90 max	volts

Typical Operation:

Target Voltage.....	315	volts
Deflecting-Electrode-No.1 Voltage.....	0	volts
Deflecting-Electrode-No.2 Voltage.....	0	volts
Deflecting-Electrode-No.3 Voltage.....	0	volts
Cathode Resistor (Approx.).....	3300	ohms
Deflection Sensitivity (Approx.)#.....	1	mm/volt
Grid Voltage for Fluorescence Cutoff (Approx.)*.....	-6	volts

#For first millimeter of unbalance in FM application.

*The grid should be connected to the cathode when not used for fluorescence control.

TWIN DIODE—HIGH-MU TRIODE

6AQ7-GT

Glass octal type used as FM detector and audio amplifier in circuits which require diode and triode units with separate cathodes. Outline 17, OUTLINES SECTION. Tube requires

octal socket. Heater volts (ac/dc), 6.3; amperes, 0.3. Ratings and characteristics of triode unit as class A₁ amplifier: plate volts, 250 max; grid volts, -2; amplification factor, 70; plate resistance (approx.), 44000 ohms; transconductance, 1600 μmhos; plate ma., 2.3.

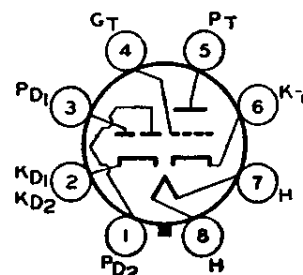

POWER PENTODE

6AR5

Miniature type used as output tube primarily in automobile receivers and ac-operated receivers. Outline 13, OUTLINES SECTION. Tube requires miniature seven-contact socket and

may be mounted in any position. For heater and cathode considerations, refer to miniature type 6AQ5. Within its maximum ratings, type 6AR5 is equivalent in performance to glass-octal type 6K6-GT. Refer to type 6K6-GT for characteristic curves.

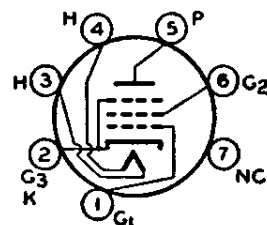

HEATER VOLTAGE (AC/DC).....	6.3	volts
HEATER CURRENT.....	0.4	ampere

CLASS A₁ AMPLIFIER

Maximum Ratings:

PLATE VOLTAGE	250 <i>max</i>	volts
GRID-NO.2 (SCREEN) VOLTAGE	250 <i>max</i>	volts
PLATE DISSIPATION	8.5 <i>max</i>	watts
GRID-NO.2 DISSIPATION	2.5 <i>max</i>	watts
PEAK HEATER-CATHODE VOLTAGE:		
Heater negative with respect to cathode	90 <i>max</i>	volts
Heater positive with respect to cathode	90 <i>max</i>	volts

Typical Operation and Characteristics:

Plate Voltage	250	250	volts
Grid-No.2 Voltage	250	250	volts
Grid-No.1 (Control-Grid) Voltage	-16.5	-18	volts
Peak AF Grid-No.1 Voltage	16.5	18	volts
Zero-Signal Plate Current	34	32	ma
Maximum-Signal Plate Current	35	33	ma
Zero-Signal Grid-No.2 Current	5.7	5.5	ma
Maximum-Signal Grid-No.2 Current	10	10	ma
Plate Resistance (Approx.)	65000	68000	ohms
Transconductance	2400	2300	μmhos
Load Resistance	7000	7600	ohms
Total Harmonic Distortion	7	11	per cent
Maximum-Signal Power Output	3.2	3.4	watts

Maximum Circuit Values (For maximum rated conditions):

Grid-No.1-Circuit Resistance	{ Fixed Bias	0.5 <i>max</i>	megohm
	{ Cathode Bias	0.1 <i>max</i>	megohm

BEAM POWER AMPLIFIER

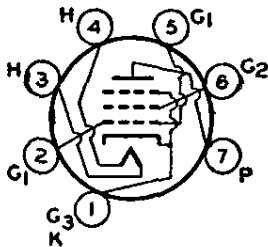

Miniature type used as output amplifier primarily in automobile and in ac-operated receivers. Outline 13, OUTLINES SECTION. Tube requires miniature seven-contact socket and may be mounted in any position. For heater and cathode considerations, refer to type 6AQ5. For curves, refer to type 35B5.

6AS5

HEATER VOLTAGE (AC/DC)	6.3	volts
HEATER CURRENT	0.8	ampere
DIRECT INTERELECTRODE CAPACITANCES (Approx.):*		
Grid No.1 to Plate	0.6	μf
Input	12	μf
Output	6.2	μf

* With no external shield.

CLASS A₁ AMPLIFIER

Maximum Ratings:

PLATE VOLTAGE	150 <i>max</i>	volts
GRID-NO.2 (SCREEN) VOLTAGE	117 <i>max</i>	volts
PLATE DISSIPATION	5.5 <i>max</i>	watts
GRID-NO.2 DISSIPATION	1.0 <i>max</i>	watt
PEAK HEATER-CATHODE VOLTAGE:		
Heater negative with respect to cathode	90 <i>max</i>	volts
Heater positive with respect to cathode	90 <i>max</i>	volts
BULB TEMPERATURE (At hottest point on bulb surface)	250 <i>max</i>	°C

Typical Operation:

Plate Voltage	150	volts
Grid-No.2 Voltage	110	volts
Grid-No.1 (Control-Grid) Voltage	-8.5	volts
Peak AF Grid-No.1 Voltage	8.5	volts
Zero-Signal Plate Current	35	ma
Maximum Signal Plate Current	36	ma
Zero-Signal Grid-No.2 Current (Approx.)	2	ma
Maximum-Signal Grid-No.2 Current (Approx.)	6.5	ma
Transconductance	5600	μmhos
Load Resistance	4500	ohms
Total Harmonic Distortion	10	per cent
Maximum-Signal Power Output	2.2	watts

Maximum Circuit Values (For maximum rated conditions):

Grid-No.1-Circuit Resistance	{ Fixed Bias	0.5 <i>max</i>	megohm
	{ Cathode Bias	0.1 <i>max</i>	megohm

**TWIN DIODE—
HIGH-MU TRIODE**

6AV6

Miniature type used as combined detector, amplifier, and avc tube in automobile and ac-operated radio receivers. Outline 10, OUTLINES SECTION. Tube requires miniature seven-contact socket and may be mounted in any position. For typical operation

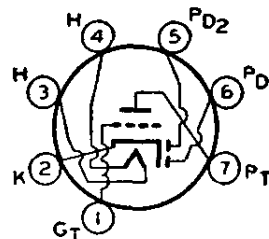

as resistance-coupled amplifier, refer to Chart 25, RESISTANCE-COUPLED AMPLIFIER SECTION. For heater considerations, refer to type 6AT6.

HEATER VOLTAGE (AC/DC)	6.3	volts
HEATER CURRENT	0.3	ampere

Maximum Ratings: TRIODE UNIT AS CLASS A₁ AMPLIFIER

PLATE VOLTAGE	300 max	volts
PEAK HEATER-CATHODE VOLTAGE:		
Heater negative with respect to cathode	90 max	volts
Heater positive with respect to cathode	90 max	volts

Characteristics:

Plate Voltage	100	250	volts
Grid Voltage	-1	-2	volts
Amplification Factor	100	100	
Plate Resistance	80000	62500	ohms
Transconductance	1250	1600	μmhos
Plate Current	0.50	1.2	ma

DIODE UNITS

The two diode plates are placed around a cathode, the sleeve of which is common to the triode unit. Each diode plate has its own base pin. Diode biasing of the triode unit is not recommended. For diode operation curves, refer to type 6SQ7.

PENTAGRID CONVERTER

6BA7

Miniature type used as converter in superheterodyne circuits especially those for the FM broadcast band. Except for overall length of 2⁵/₈ inches and seated height of 2³/₈ inches, the

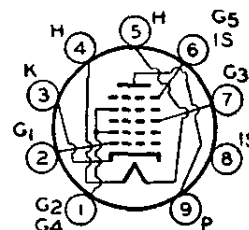

dimensions of type 6BA7 are given by Outline 11, OUTLINES SECTION. Tube requires noval nine-contact socket and may be mounted in any position. Its characteristics are similar to those of metal type 6SB7-Y. For heater and cathode considerations, refer to type 6AT6.

HEATER VOLTAGE (AC/DC)	6.3	volts
HEATER CURRENT	0.3	ampere

DIRECT INTERELECTRODE CAPACITANCES (Without shield):

Grid No.3 to All Other Electrodes (RF Input)	9.5	μμf
Plate to All Other Electrodes (Mixer Output)	8.3	μμf
Grid No.1 to All Other Electrodes (Oscillator Input)	6.7	μμf
Grid No.3 to Plate	0.19 max	μμf
Grid No.1 to Grid No.3	0.1 max	μμf
Grid No.1 to Plate	0.05 max	μμf
Grid No.1 to All Other Electrodes Except Cathode	3.4	μμf
Grid No.1 to Cathode	3.3	μμf
Cathode to All Other Electrodes Except Grid No.1	4.0	μμf

CONVERTER SERVICE

Maximum Ratings:

PLATE VOLTAGE	300 max	volts
GRID-NO.5-AND-INTERNAL-SHIELD VOLTAGE▲	0 max	volts
GRIDS-NO.2-AND-NO.4 VOLTAGE	100 max	volts
GRIDS-NO.2-AND-NO.4 SUPPLY VOLTAGE	300 max	volts
PLATE DISSIPATION	2.0 max	watts
GRIDS-NO.2-AND-NO.4 DISSIPATION	1.5 max	watts
TOTAL CATHODE CURRENT	22 max	ma
GRID-NO.3 VOLTAGE:		
Negative bias voltage	100 max	volts
Positive bias voltage	0 max	volts
PEAK HEATER-CATHODE VOLTAGE:		
Heater negative with respect to cathode	90 max	volts
Heater positive with respect to cathode	90 max	volts

Characteristics (Separate Excitation):*

Plate Voltage	100	250	volts
Grid No.5 and Internal Shield▲	Connected directly to ground		
Grids-No.2-and-No.4 (Screen) Voltage	100	100	volts
Grid-No.3 (Control-Grid) Voltage	-1.0	-1.0	volt
Grid-No.1 (Oscillator-Grid) Resistor	20000	20000	ohms
Plate Resistance (Approx.)	0.5	1.0	megohm
Conversion Transconductance	900	950	μmhos
Conversion Transconductance (Approx.)**	3.5	3.5	μmhos
Plate Current	3.6	3.8	ma
Grids-No.2-and-No.4 Current	10.2	10	ma
Grid-No.1 Current	0.35	0.35	ma
Total Cathode Current	14.2	14.2	ma

NOTE: The transconductance between grid No.1 and grids No.2 and No.4 connected to plate (not oscillating) is approximately 8000 μmhos under the following conditions: signal applied to grid No.1 at zero bias; grids No.2 and No.4 and plate at 100 volts; grid No.3 grounded. Under the same conditions, the plate current is 32 milliamperes, and the amplification factor is 16.5.

*The characteristics shown with separate excitation correspond very closely with those obtained in a self-excited oscillator circuit operating with zero bias.

**With grid-No.3 bias of -20 volts.

▲Internal Shield (pins No.6 and No.8) connected directly to ground.

NOTE ON CURVES: In the 6BA7 operation characteristics with self-excitation, E_k is the voltage across the oscillator-coil section between cathode and ground; E_g is the oscillator voltage between cathode and grid.

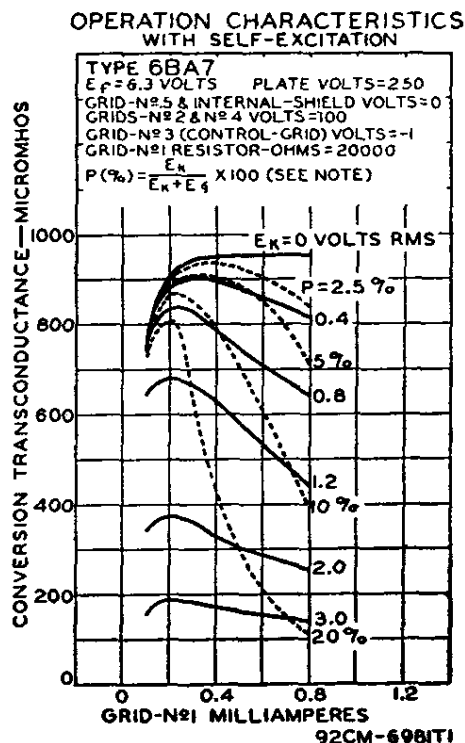
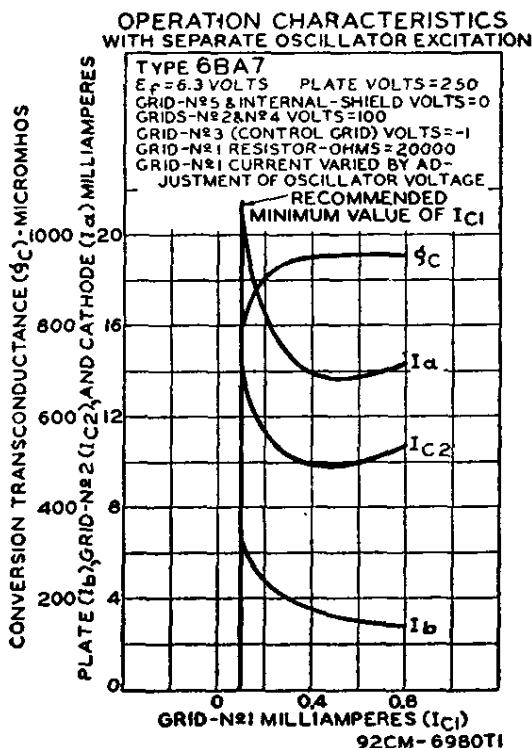

SHARP-CUTOFF PENTODE

6BH6

Miniature type used as rf amplifier particularly in ac/dc receivers and in mobile equipment where low heater-current drain is important. It is particularly useful in high-frequency, wide-band applications. Outline 10, OUTLINES SECTION. Tube requires miniature seven-contact socket and may be mounted in any position. For heater and cathode considerations, refer to type 6AT6.

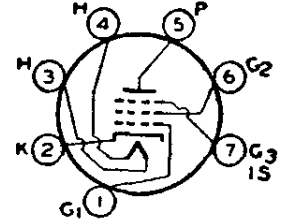

HEATER VOLTAGE (AC/DC).....	6.3	volts
HEATER CURRENT.....	0.15	ampere
DIRECT INTERELECTRODE CAPACITANCES (No external shield):		
Grid No.1 to Plate.....	0.0035 max	μmf
Input.....	5.4	μmf
Output.....	4.4	μmf

Maximum Ratings:

CLASS A₁ AMPLIFIER

PLATE VOLTAGE.....	330 max	volts
GRID-NO.2 (SCREEN) VOLTAGE.....	150 max	volts
GRID-NO.2 SUPPLY VOLTAGE.....	300 max	volts
PLATE DISSIPATION.....	3 max	watts
GRID-NO.2 DISSIPATION.....	0.5 max	watt
GRID-NO.1 (CONTROL-GRID) VOLTAGE:		
Negative bias value.....	50 max	volts
Positive bias value.....	0 max	volts
PEAK HEATER-CATHODE VOLTAGE:		
Heater negative with respect to cathode.....	90 max	volts
Heater positive with respect to cathode.....	90 max	volts

Typical Operation and Characteristics:

Plate Voltage.....	100	250	volts
Grid-No.3 (Suppressor).....	Connected to cathode at socket		
Grid-No.2 Voltage.....	100	150	volts
Grid-No.1 Voltage.....	-1	-1	volt
Plate Resistance (Approx.).....	0.7	1.4	megohms
Transconductance.....	3400	4600	μmhos
Grid-No.1 Bias for plate current of 10 μa	-5	-7.7	volts
Plate Current.....	3.6	7.4	ma
Grid-No.2 Current.....	1.4	2.9	ma

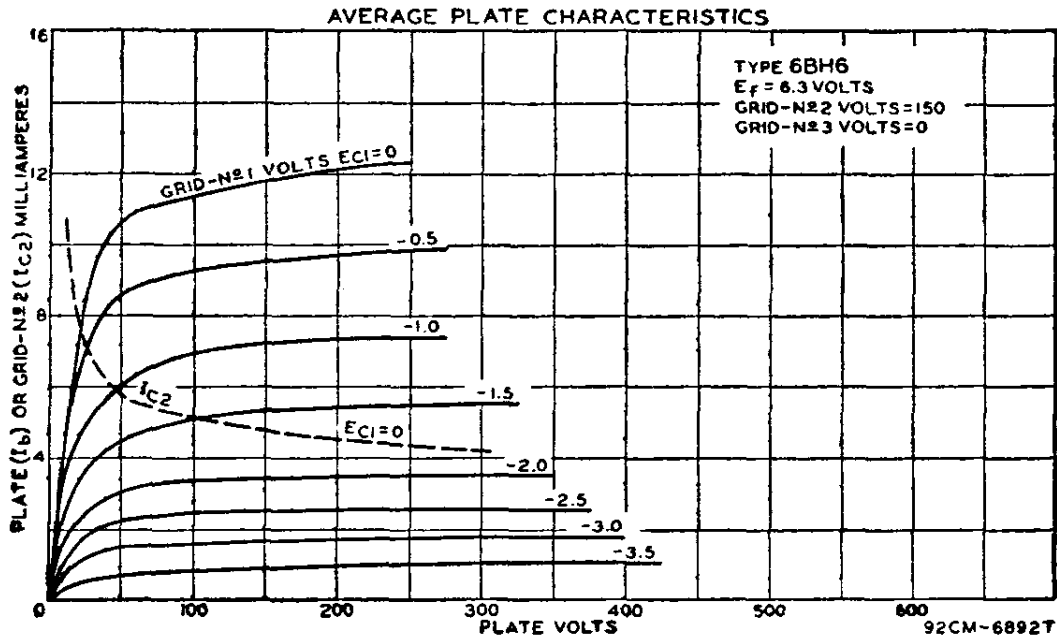

TRIPLE DIODE—HIGH-MU TRIODE

6T8

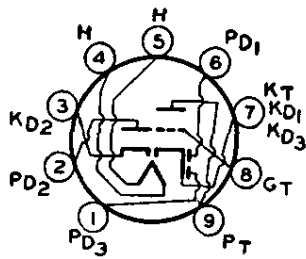

Miniature type used as combined audio amplifier, AM detector, and FM detector in AM/FM radio receivers. Diode unit No.1 is used for AM detection, and diode units No.2 and No.3

are used for FM detection. Outline 11, OUTLINES SECTION. Tube requires noval nine-contact socket and may be mounted in any position. For heater and cathode considerations, refer to type 6AQ5.

HEATER VOLTAGE (AC/DC).....	6.3	volts
HEATER CURRENT.....	0.45	ampere
DIRECT INTERELECTRODE CAPACITANCES:*		
Triode Grid to Plate.....	2.2	μf
Triode Grid to Cathode and Heater.....	1.6	μf
Triode Plate to Cathode and Heater.....	1.0	μf
Diode-No.1 Plate to Cathode and Heater.....	3.8	μf
Diode-No.2 Plate to Cathode and Heater.....	4.5	μf
Diode-No.3 Plate to Cathode and Heater.....	3.8	μf
Diode-No.2 Cathode to All Other Electrodes.....	8.5	μf
Triode Grid to Any Diode Plate.....	0.035 max	μf

*No external shield. Approximate values.

Maximum Ratings: TRIODE UNIT AS CLASS A₁ AMPLIFIER

PLATE VOLTAGE.....	300 max	volts
PLATE DISSIPATION.....	1 max	watt
PEAK HEATER-CATHODE VOLTAGE:		
Heater negative with respect to cathode.....	90 max	volts
Heater positive with respect to cathode.....	90 max	volts

Characteristics:

Plate Voltage.....	100	250	volts
Grid Voltage.....	-1	-3	volts
Amplification Factor.....	70	70	
Plate Resistance.....	54000	58000	ohms
Transconductance.....	1300	1200	μmhos
Plate Current.....	0.8	1.0	ma

DIODE UNITS

Diode units No.1 and No.3 have a common cathode. Diode unit No.2 has a separate cathode.

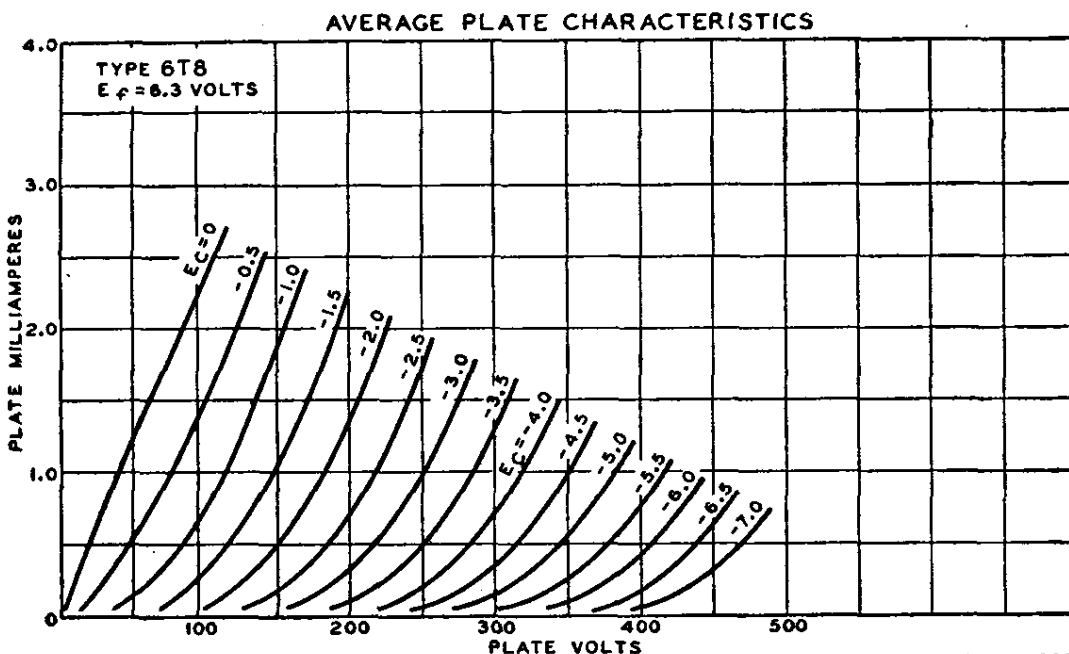

**HALF-WAVE
VACUUM RECTIFIER**

6W4-GT

Glass octal type used as damper diode in magnetic deflection circuit of television receivers and as a rectifier in conventional power-supply applications. Dimensions of type 6W4-GT are

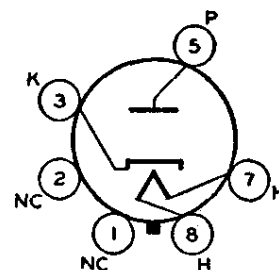

given by Outline 17, OUTLINES SECTION, but the 6W4-GT has a short intermediate-shell octal 6-pin base. Tube requires octal socket and may be mounted in any position. It is especially important that this tube, like other power-handling tubes, should be adequately ventilated.

Maximum Ratings:

DAMPER SERVICE

PEAK INVERSE PLATE VOLTAGE.....	2000* <i>max</i>	volts
PEAK PLATE CURRENT.....	600 <i>max</i>	ma
DC PLATE CURRENT.....	125 <i>max</i>	ma

PEAK HEATER-CATHODE VOLTAGE:

Heater negative with respect to cathode.....	450 <i>max</i>	volts
Heater positive with respect to cathode.....	100 <i>max</i>	volts

*Applicable when duty cycle of voltage pulse does not exceed 15 per cent of one scanning cycle, and its duration is limited to 10 microseconds.

Maximum Ratings:

RECTIFIER SERVICE

PEAK INVERSE PLATE VOLTAGE.....	1250 <i>max</i>	volts
PEAK PLATE CURRENT.....	600 <i>max</i>	ma
HOT-SWITCHING TRANSIENT PLATE CURRENT (For duration of 0.2 second <i>max</i>).....	3.5 <i>max</i>	amperes
DC OUTPUT CURRENT.....	125 <i>max</i>	ma

PEAK HEATER-CATHODE VOLTAGE:

Heater negative with respect to cathode.....	450 <i>max</i>	volts
Heater positive with respect to cathode.....	100 <i>max</i>	volts

Typical Operation (Capacitor-Input Filter):

	<i>Half-Wave Rectifier (One Tube)</i>	<i>Full-Wave Rectifier (Two Tubes)</i>	
AC Plate-to-Plate Supply Voltage (RMS).....	—	700	volts
AC Plate-Supply Voltage (RMS).....	350	—	volts
Filter-Input Capacitor.....	20	20	μf
Minimum Total Effective Plate-Supply Impedance per Plate..	145	145	ohms
DC Output Current.....	125	150	ma
DC Output Voltage at Input to Filter (Approx.):			
At half-load current of { 62.5 ma.....	390	—	volts
{ 125 ma.....	—	395	volts
At full-load current of { 125 ma.....	335	—	volts
{ 250 ma.....	—	350	volts
Voltage Regulation (Approx.):			
Half-load to full-load current.....	55	45	volts

POWER PENTODE

7AD7

Lock-in type used in output stage of video amplifier of television receivers. Outline 15, OUTLINES SECTION. Tube requires lock-in socket. Heater volts (ac/dc), 6.3; amperes, 0.6. Typical operation and ratings as class A₁ video amplifier: plate volts, 300 *max*; grid-No.2 volts, 150 *max*; plate dissipation, 10 *max* watts; grid-No.2 dissipation, 1.2 *max* watts; cathode re-

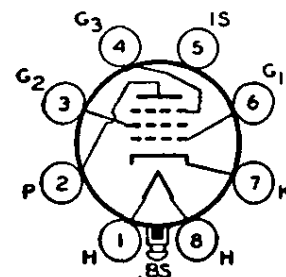

resistor, 68 ohms; plate ma., 28; grid-No.2 ma., 7; plate resistance ,30000 ohms; transconductance, 9590 μmbos.

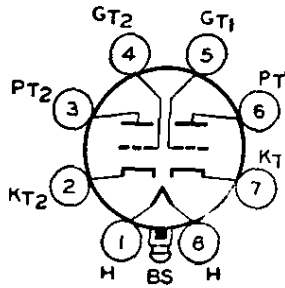

MEDIUM-MU TWIN TRIODE

Glass lock-in type used as voltage amplifier or phase inverter in radio equipment. Outline 12, OUTLINES SECTION. Tube requires lock-in socket. Heater volts (ac/dc), 6.3; amperes, 0.3. Ratings and characteristics as class A₁ amplifier (each section): plate volts, 250 (300 max); cathode resistor, 1100 ohms; plate ma., 9; transconductance, 2100 μmhos; amplification factor, 16; plate resistance, 7600 ohms.

7AF7

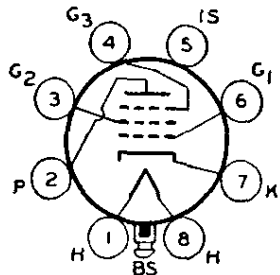

SHARP-CUTOFF PENTODE

Glass lock-in type used as rf amplifier in ac/dc receivers or in mobile equipment where low heater-current drain is important. Outline 12, OUTLINES SECTION. Tube requires lock-in socket. Heater volts (ac/dc), 6.3; amperes, 0.15. Maximum ratings and characteristics as class A₁ amplifier: plate and grid-No.2 volts, 250 (300 max); plate dissipation, 2 max watts; grid-No.2 dissipation, 0.75 max watt;

7AG7

grid-No.1 volts, -2; grid No.3 and internal shield connected to cathode at socket; plate resistance (approx.), 0.75 megohm; transconductance, 4200 μmhos; grid-No.1 volts for plate current of 10 μa, -10; plate ma., 6; grid-No.2 ma., 2. The application of this type is similar to that of miniature type 6BH6.

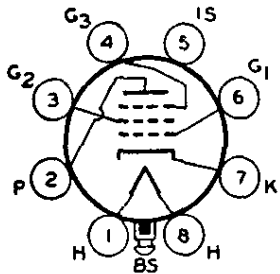

REMOTE-CUTOFF PENTODE

Glass lock-in type used as rf amplifier in high-frequency and wide-band applications. Outline 12, OUTLINES SECTION. Tube requires lock-in socket. Heater volts (ac/dc), 6.3; amperes, 0.15. Maximum ratings and characteristics as class A₁ amplifier: plate and grid-No.2 volts, 250 (300 max); plate dissipation, 2 max watts; grid-No.2 dissipation, 0.7 max watt; bias resistor, 250 ohms; grid No.3 and internal shield

7AH7

connected to cathode at socket; plate resistance (approx.), 1 megohm; transconductance, 3300 μmhos; grid-No.1 volts for transconductance of 35 μmhos, -20 volts; plate ma., 6.8; grid-No.2 ma., 1.9. The application of this type is similar to that of miniature type 6BJ6.

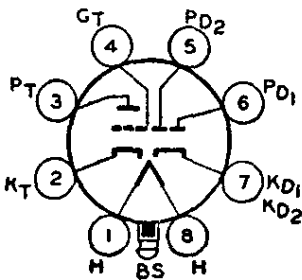

TWIN DIODE—HIGH-MU TRIODE

Glass lock-in type used as FM detector and audio amplifier in circuits which require diode and triode units with separate cathodes. Outline 12, OUTLINES SECTION. Tube requires lock-in socket. Heater volts (ac/dc), 6.3; amperes, 0.3. For ratings and typical operation, refer to glass-octal type 6AQ7-GT.

7K7

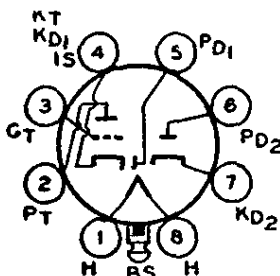

TWIN DIODE—HIGH-MU TRIODE

Glass lock-in type used as combined detector, amplifier, and avc tube in circuits which require diodes with separate cathodes. Outline 15, OUTLINES SECTION. Tube requires lock-in socket. Heater volts (ac/dc), 6.3; amperes, 0.3. Ratings and characteristics of triode unit as class A₁ amplifier: plate volts, 250 (300 max); grid volts, -1; amplification factor, 100; plate resistance, 67000 ohms; transconductance, 1500 μmhos; plate ma., 1.9.

7X7

12AT7

HIGH-MU TWIN TRIODE

Miniature type used as grounded-grid amplifier or frequency converter in the FM and television broadcast bands. Outline 11, **OUTLINES SECTION**. Tube requires noval nine-contact socket and may be mounted in any position. Each triode unit is independent of the other except for the common heater.

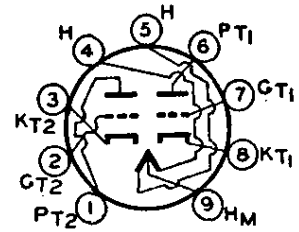

HEATER ARRANGEMENT	<i>Series</i>	<i>Parallel</i>	
HEATER VOLTAGE (AC/DC)	12.6	6.3	volts
HEATER CURRENT	0.15	0.3	ampere

DIRECT INTERELECTRODE CAPACITANCES (No external shield):

<i>Grounded-Cathode Operation</i>			
Grid to Plate (Each Unit)	1.45		μf
Grid to Heater and Cathode (Each Unit)	2.5		μf
Plate to Heater and Cathode (Unit No.1)	0.45		μf
Plate to Heater and Cathode (Unit No.2)	0.35		μf
Grid to Grid	0.005 max		μf
Plate to Plate	0.4 max		μf
Heater to Cathode (Each Unit)	2.5		μf
<i>Grounded-Grid Operation</i>			
Plate to Cathode (Each Unit)	0.15		μf
Cathode to Heater and Grid (Each Unit)	5.0		μf
Plate to Heater and Grid (Unit No.1)	1.6		μf
Plate to Heater and Grid (Unit No.2)	1.5		μf

Maximum Ratings:

CLASS A₁ AMPLIFIER (Each Unit)			
PLATE VOLTAGE		300	volts
PLATE DISSIPATION		2.5	watts
PEAK HEATER-CATHODE VOLTAGE:			
Heater negative with respect to cathode		90	volts
Heater positive with respect to cathode		90	volts

Characteristics:

Plate Voltage	100	180	250	volts
Grid Voltage	-1	-1	-2	volts
Amplification Factor	54	62	55	
Plate Resistance (Approx.)	13500	9400	10000	ohms
Transconductance	4000	6600	5500	μmhos
Plate Current	3.7	11	10	ma

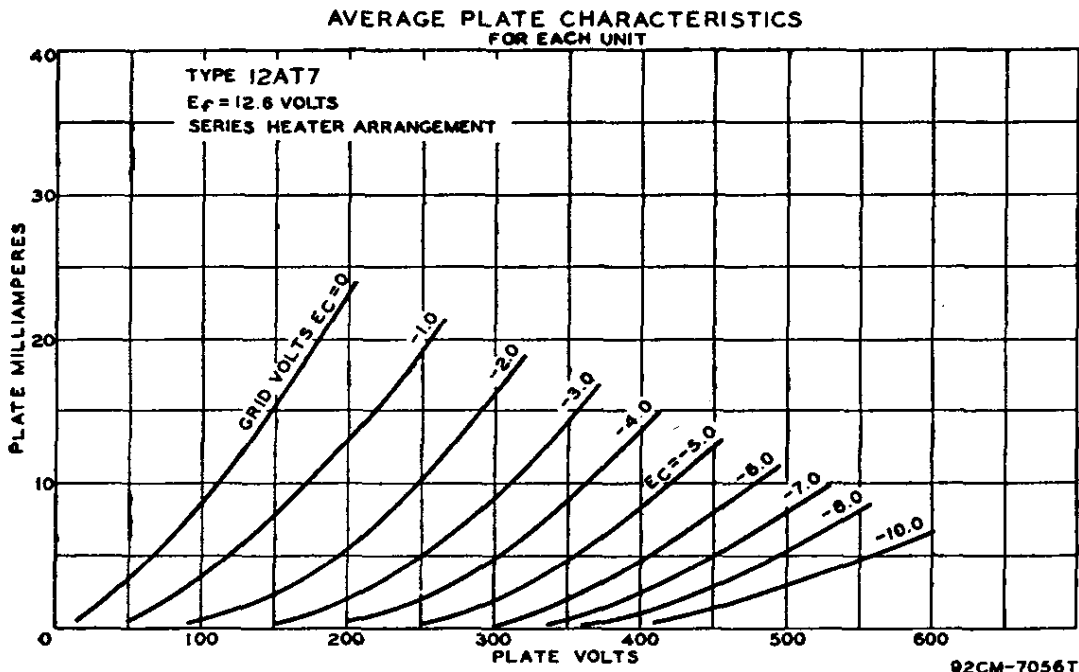

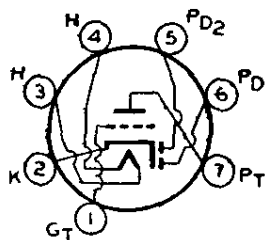

**TWIN DIODE—
HIGH-MU TRIODE**

12AV6

Miniature type used as combined detector, amplifier, and avc tube in automobile and ac-operated receivers. Outline 10, OUTLINES SECTION.

Heater volts (ac/dc), 12.6; amperes, 0.15. Except for heater rating, this type is identical with miniature type 6AV6.

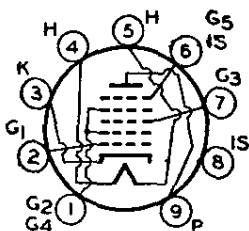

PENTAGRID CONVERTER

12BA7

Miniature type used as converter in ac/dc superheterodyne circuits especially those for the FM broadcast band. Except for overall length of 2⁵/₈ inches and seated height of 2³/₈ inches,

the dimensions of type 12BA7 are given by Outline 11, OUTLINES SECTION. Heater volts (ac/dc), 12.6; amperes, 0.15. Except for heater rating, this type is identical with miniature type 6BA7.

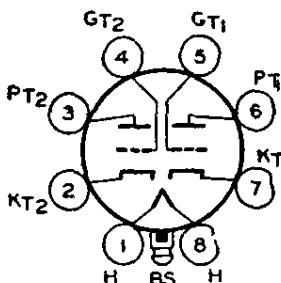

MEDIUM-MU TWIN TRIODE

14AF7

Glass lock-in type used as voltage amplifier or phase inverter in radio equipment. Outline 12, OUTLINES SECTION. Tube requires lock-in socket. Heater volts (ac/dc), 12.6; amperes, 0.15. Except for heater ratings, this type is electrically identical with lock-in type 7AF7.

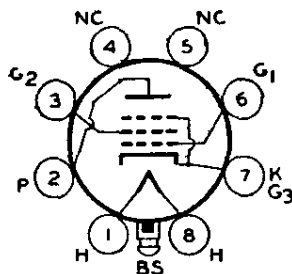

BEAM POWER AMPLIFIER

14C5

Glass lock-in type used as output amplifier in ac/dc radio receivers. Outline 15, OUTLINES SECTION. Tube requires lock-in socket. Heater volts (ac/dc), 12.6; amperes, 0.225. Except for heater rating, this type is electrically identical with lock-in type 7C5 and metal type 6V6.

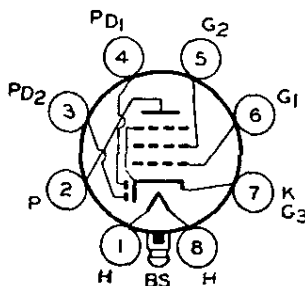

**TWIN DIODE—REMOTE-CUTOFF
PENTODE**

14E7

Glass lock-in type used as combined detector, amplifier, and avc tube in ac/dc receivers. Outline 12, OUTLINES SECTION. Tube requires lock-in socket. Heater volts (ac/dc), 12.6; amperes, 0.15. Except for heater rating, this type is electrically identical with lock-in type 7E7.

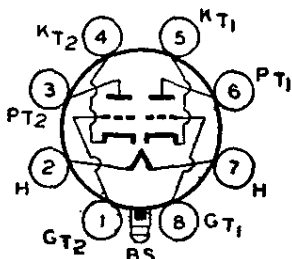

MEDIUM-MU TWIN TRIODE

14F8

Glass lock-in type used as amplifier or oscillator in ac/dc radio equipment. Except for overall length of 2-9/32 inches and seated height of 1³/₄ inches, the dimensions of type 14F8 are given by Outline 12, OUTLINES SECTION. Tube requires lock-in socket. Heater volts (ac/dc), 12.6; amperes, 0.15. Except for heater rating, this type is electrically identical with lock-in type 7F8.

19J6

MEDIUM-MU TWIN TRIODE

Miniature type used for converter service in ac/dc AM and FM receivers and as oscillator, amplifier, or mixer in television receivers of the "transformerless" type. Outline 10, OUTLINES

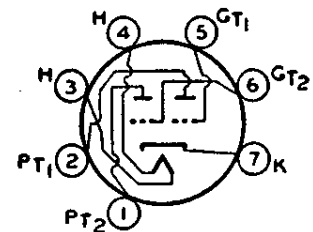

SECTION. Tube requires miniature seven-contact socket and may be mounted in any position. For direct interelectrode capacitances, ratings, and typical operation as a class A₁ amplifier, and curves, refer to type 6J6.

HEATER VOLTAGE (AC/DC).....	18.9	volts
HEATER CURRENT.....	0.15	ampere

MIXER SERVICE Values are for each unit.

Maximum Ratings:

PLATE VOLTAGE.....	300 max	volts
PLATE DISSIPATION.....	1.5 max	watts
PEAK HEATER-CATHODE VOLTAGE:		
Heater negative with respect to cathode.....	90 max	volts
Heater positive with respect to cathode.....	90 max	volts

Typical Operation and Characteristics:

Plate Voltage.....	150	volts
Cathode-Bias Resistor*.....	810	ohms
Peak Oscillator Voltage.....	3	volts
Plate Resistance.....	10200	ohms
Conversion Transconductance.....	1900	μmhos
Plate Current.....	4.8	ma

* Under maximum rated conditions, the resistance in the grid circuit should not exceed 0.5 megohm with cathode bias. Operation with fixed bias is not recommended.

19T8

TRIPLE DIODE—HIGH-MU TRIODE

Miniature type used as combined audio amplifier, AM detector, and FM detector in AM/FM receivers of the ac/dc or "transformerless" type. Outline 11, OUTLINES SECTION. Tube

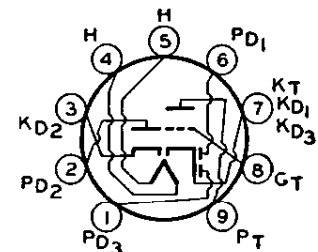

requires noval nine-contact socket and may be mounted in any position. Heater volts (ac/dc), 18.9; amperes, 0.15. Except for heater rating, this type is identical with miniature type 6T8.

35C5

BEAM POWER AMPLIFIER

Miniature type used in output stage of compact, ac/dc radio receivers. Because of its high power sensitivity and high efficiency at plate and screen voltages available in ac/dc receivers, the 35C5 is capable of providing a relatively high power output. Outline

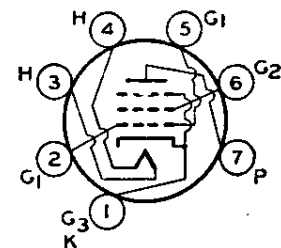

13, OUTLINES SECTION. Tube requires miniature seven-contact socket and may be mounted in any position. Except for terminal connections and slightly higher ratings, type 35C5 is equivalent in performance to miniature type 35B5 and, within its maximum ratings, to glass-octal type 35L6-GT. The basing arrangement of the 35C5 simplifies the problem of meeting Underwriters' Laboratories requirements in the design of ac/dc receivers. Refer to type 35B5 for installation and application considerations and curves.

RCA RECEIVING TUBE MANUAL

HEATER VOLTAGE (AC/DC).....	35	volts
HEATER CURRENT.....	0.15	ampere
DIRECT INTERELECTRODE CAPACITANCES (Approx.): ^o		
Grid No.1 to Plate	0.57	μmf
Input.....	12	μmf
Output.....	6.2	μmf

^o With no external shield.

Maximum Ratings: CLASS A₁ AMPLIFIER

PLATE VOLTAGE.....	135 <i>max</i>	volts
GRID-NO.2 (SCREEN) VOLTAGE.....	117 <i>max</i>	volts
PLATE DISSIPATION.....	4.5 <i>max</i>	watts
GRID-NO.2 DISSIPATION.....	1.0 <i>max</i>	watt
PEAK HEATER-CATHODE VOLTAGE:		
Heater negative with respect to cathode.....	180 <i>max</i>	volts
Heater positive with respect to cathode.....	180 <i>max</i>	volts
BULB TEMPERATURE (At hottest point on bulb surface).....	250 <i>max</i>	°C

Typical Operation:

Plate Voltage.....	110	volts
Grid-No.2 Voltage.....	110	volts
Peak AF Grid-No.1 Voltage.....	7.5	volts
Zero-Signal Plate Current.....	40	ma
Maximum-Signal Plate Current.....	41	ma
Zero-Signal Grid-No.2 Current (Approx.).....	3	ma
Maximum-Signal Grid-No.2 Current (Approx.).....	7	ma
Transconductance.....	5800	μmhos
Load Resistance.....	2500	ohms
Total Harmonic Distortion.....	10	per cent
Maximum-Signal Power Output.....	1.5	watts

Maximum Circuit Values (For maximum rated conditions):

Grid-No.1-Circuit Resistance	{ Cathode Bias.....	0.5 <i>max</i>	megohm
	Fixed Bias.....	0.1 <i>max</i>	megohm

BEAM POWER AMPLIFIER

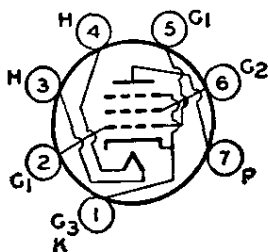

Miniature type used in output stage of compact, ac/dc radio receivers. Because of its high power sensitivity and high efficiency at plate and screen voltages available in ac/dc receivers, the 50C5 is capable of providing a relatively high power output. Outline

50C5

13, OUTLINES SECTION. Tube requires miniature seven-contact socket and may be mounted in any position. Except for terminal connections and slightly higher ratings, type 50C5 is equivalent in performance to miniature type 50B5 and, within its maximum ratings, to glass-octal type 50L6-GT. The basing arrangement of the 50C5 simplifies the problem of meeting Underwriters' Laboratories requirements in the design of ac/dc receivers. Refer to type 50B5 for installation and application considerations and curves.

HEATER VOLTAGE (AC/DC).....	50	volts
HEATER CURRENT.....	0.15	ampere
DIRECT INTERELECTRODE CAPACITANCES (Approx.): ^o		
Grid No.1 to Plate	0.64	μmf
Input.....	13	μmf
Output.....	6.1	μmf

^o With no external shield.

Maximum Ratings:
CLASS A₁ AMPLIFIER

PLATE VOLTAGE.....	135 <i>max</i>	volts
GRID-NO.2 (SCREEN) VOLTAGE.....	117 <i>max</i>	volts
PLATE DISSIPATION.....	5.5 <i>max</i>	watts
GRID-NO.2 DISSIPATION.....	1.25 <i>max</i>	watts
PEAK HEATER-CATHODE VOLTAGE:		
Heater negative with respect to cathode.....	180 <i>max</i>	volts
Heater positive with respect to cathode.....	180 <i>max</i>	volts
BULB TEMPERATURE (At hottest point on bulb surface).....	250 <i>max</i>	°C

Typical Operation:

Plate Voltage.....	110	volts
Grid-No.2 Voltage.....	110	volts
Grid-No.1 (Control-Grid) Voltage.....	-7.5	volts
Peak AF Grid-No.1 Voltage.....	7.5	volts
Zero-Signal Plate Current.....	49	ma
Maximum-Signal Plate Current.....	50	ma
Zero-Signal Grid-No.2 Current (Approx.).....	4	ma
Maximum-Signal Grid-No.2 Current (Approx.).....	8.5	ma
Plate Resistance (Approx.).....	10000	ohms
Transconductance.....	7500	μmhos
Load Resistance.....	2500	ohms
Total Harmonic Distortion.....	9	per cent
Maximum-Signal Power Output.....	1.9	watts

Maximum Circuit Values (For maximum rated conditions):

Grid-No.1-Circuit Resistance {	Cathode Bias.....	0.5 <i>max</i>	megohm
	Fixed Bias.....	0.1 <i>max</i>	megohm

VACUUM RECTIFIER-DOUBLER

Lock-in type used as half-wave rectifier or voltage doubler in ac/dc receivers. Outline 15, OUTLINES SECTION. Tube requires lock-in socket. Heater volts (ac/dc), 50; amperes, 0.15. This type is electrically identical with glass-octal type 50Y6-GT and, except for heater rating, with glass-octal type 25Z6-GT. Refer to type 25Z6-GT for maximum ratings, typical operation, and curves.

50X6

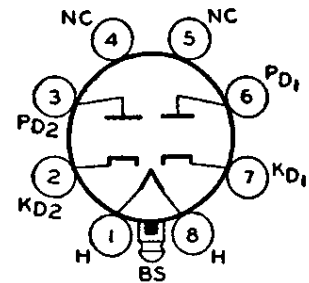

HALF-WAVE VACUUM RECTIFIER

Glass octal type used in power supply of ac/dc/battery radio receivers. Dimensions: maximum overall length, 3 inches; maximum seated height, 2 3/4 inches; maximum diameter, 1-5/16 inches; T-9 bulb; intermediate-shell octal 7-pin base. Tube requires octal socket. Heater volts (ac/dc), 117; amperes, 0.04. Maximum ratings as half-wave rectifier: peak inverse plate volts, 350 *max*; peak plate ma., 540 *max*;

117Z4-GT

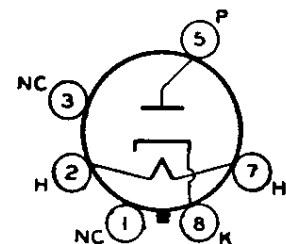

peak heater-cathode volts, 175 *max*. Typical operation with capacitor-input filter: ac plate supply volts (RMS), 117; minimum total effective plate-supply impedance, 30 ohms; dc output ma., 90.

Technical Publications on RCA Tubes

Copies of the publications listed below may be obtained from your RCA Tube Distributor, or direct from Commercial Engineering, Tube Department, Radio Corporation of America, Harrison, New Jersey.

- **TUBE HANDBOOK—ALL TYPES HB-3** (7- $\frac{3}{8}$ " x 5"). The bible of the industry—contains over 2000 pages of loose-leaf data and curves on all RCA receiving tubes, power tubes, cathode-ray tubes, phototubes, and special tubes. Three deluxe 4-prong binders imprinted in gold. Available on subscription basis. Price \$10.00* including service for first year. Write to Commercial Engineering for descriptive folder and order form.
- **RECEIVING TUBE MANUAL—RC-15** (8- $\frac{3}{8}$ " x 5- $\frac{1}{2}$ ")—256 pages. Supersedes RC-14. Completely revised and brought up to date. Contains the latest receiving tubes, including miniature types and kinescopes. Features tube theory written for the layman, application data and circuits for both AM and FM equipment, and an expanded Resistance-Coupled Amplifier Section. Price 35 cents.*
- **PHOTOTUBES BOOKLET—PT-20R1** (11" x 8- $\frac{1}{2}$ ")—16 pages. Phototube theory, data on 15 types, curves and circuits for light-operated relays, light measurements, and sound reproduction. Single copy free on request.
- **RADIOTRON DESIGNER'S HANDBOOK—**(9" x 6")—356 pages. Edited by E. Langford Smith of Amalgamated Wireless Valve Company Pty. Ltd. in Australia. Of value to anyone interested in fundamental principles of practical circuit design. Copiously illustrated. Price \$1.25.*
- **POWER AND GAS TUBES FOR RADIO AND INDUSTRY—**Bulletin PG-101 (11" x 8- $\frac{1}{2}$ ")—16 pages. Technical information on air-and-water-cooled transmitting tubes, rectifiers, thyratrons, ignitrons, and voltage regulators. Includes terminal connections. Price 10 cents.*
- **PHOTOTUBES, CATHODE-RAY AND SPECIAL TYPES—**Bulletin CRPS-102 (11" x 8- $\frac{1}{2}$ ")—16 pages. Technical information on gas- and vacuum-type phototubes, cathode-ray tubes, camera tubes, low-microphonic types, acorn types, and other small tubes for special applications. Includes terminal connections. Price 10 cents.*
- **RECEIVING TUBES FOR AM, FM, AND TELEVISION BROADCAST—**Bulletin 1275-D—24 pages. Completely revised and brought up to date. Contains characteristics for all RCA receiving tubes including kinescopes. Socket connection diagrams arranged for quick and easy reference. Price 10 cents.*
- **INSTRUCTION BOOKLETS—**Complete authorized information on RCA non-receiving types. Be sure to mention tube-type booklet desired. Single copy on any type free on request.
- **AIR-COOLED TRANSMITTING TUBES MANUAL—TT3** (8- $\frac{3}{8}$ " x 5- $\frac{3}{8}$ ")—192 pages. Published several years ago, this book still retains popularity for instruction purposes. It contains basic information on generic tube types, tube parts and materials, tube ratings, tube installation and application, transmitter-design considerations, rectifiers and filters, as well as data on many of the older tube types. Price 35 cents.*
- **QUICK-REFERENCE CHART, MINIATURE TUBES—**Bulletin MNT-30A (11" x 8- $\frac{1}{2}$ ")—4 pages. Contains characteristics, socket connections, and descriptions for RCA miniature tubes. Shows equivalent metal and GT types. Single copy free on request.
- **HEADLINERS FOR HAMS—**Bulletin HAM-103 (11" x 8- $\frac{1}{2}$ ")—4 pages. Technical information, terminal connections, and prices on RCA "HAM" PREFERENCE TYPES: class B modulators, class C amplifiers and oscillators, frequency doublers, rectifiers, thyratrons, and voltage regulators. Single copy free on request.
- **RCA PREFERRED TYPES LIST—**Bulletin PTL-501 (11" x 8- $\frac{1}{2}$ ")—4 pages. Lists RCA Preferred Tube Types, both receiving and non-receiving, by function. An aid to equipment designers in the selection of tube types for new equipment design. Single copy free on request.
- **QUICK SELECTION GUIDE, NON-RECEIVING TYPES—**Bulletin 2F403 (11" x 8- $\frac{1}{2}$ ")—4 pages. Contains brief identifying technical data on over 260 non-receiving types: vacuum power tubes, rectifier tubes, thyratrons, ignitrons, voltage regulators, phototubes, cathode-ray tubes and special types. Single copy free on request.

*Prices shown apply in U.S.A. and are subject to change without notice.

Reading List

The following list of references gives texts of both elementary and advanced character. Obviously, the list is not inclusive, but it will guide the reader to other references.

ALBERT, A. L. *Fundamental Electronics and Vacuum Tubes*. The MacMillan Co.

CHAFFEE, E. L. *Theory of Thermionic Vacuum Tubes*. McGraw-Hill Book Co., Inc.

CHUTE, G. M. *Electronics in Industry*. McGraw-Hill Book Co., Inc.

COOKE, N. M. *Mathematics for Electricians and Radiomen*. McGraw-Hill Book Co., Inc.

DOW, W. G. *Fundamentals of Engineering Electronics*. John Wiley and Sons, Inc.

EASTMAN, A. V. *Fundamentals of Vacuum Tubes*. McGraw-Hill Book Co., Inc.

EVERITT, W. L. *Communication Engineering*. McGraw-Hill Book Co., Inc.

FINK, D. G. *Engineering Electronics*. McGraw-Hill Book Co., Inc.

FINK, D. G. *Principles of Television Engineering*. McGraw-Hill Book Co., Inc.

GHIRARDI, A. A. *Modern Radio Servicing*. Radio and Technical Publishing Co., Inc.

HENNEY, KEITH *Radio Engineering Handbook* McGraw-Hill Book Co., Inc.

HOAG, J. B. *Basic Radio*. D. Van Nostrand Co., Inc.

KOLLER, L. R. *Physics of Electron tubes*. McGraw-Hill Book Co., Inc.

LAUER AND BROWN. *Radio Engineering Principles*. McGraw-Hill Book Co., Inc.

MCILWAIN AND BRAINERD. *High-Frequency Alternating Currents*. John Wiley and Sons, Inc.

M.I.T. ELECTRICAL ENGINEERING STAFF. *Applied Electronics*. John Wiley and Sons, Inc.

MOYER AND WOSTREL. *Radio Receiving and Television Tubes*. McGraw-Hill Book Co., Inc.

PENDER, DELMAR, AND MCILWAIN. *Handbook for Electrical Engineers—Communications and Electronics*. John Wiley and Sons, Inc.

PREISMAN, A. *Graphical Constructions for Vacuum Tube Circuits*. McGraw-Hill Book Co., Inc.

Proceedings of the Institute of Radio Engineers (a monthly publication).

REICH, H. J. *Theory and Applications of Electron Tubes*. McGraw-Hill Book Co., Inc.

RICHTER, WALTHER. *Fundamentals of Industrial Electronic Circuits*. McGraw-Hill Book Co., Inc.

TERMAN, F. E. *Fundamentals of Radio*. McGraw-Hill Book Co., Inc.

TERMAN, F. E. *Radio Engineering*. McGraw-Hill Book Co., Inc.

TERMAN, F. E. *Radio Engineers Handbook*. McGraw-Hill Book Co., Inc.

The Radio Amateurs Handbook. American Radio Relay League.

VAN DER BIJL, H. J. *Thermionic Vacuum Tubes*. McGraw-Hill Book Co., Inc.

ZWORYKIN AND MORTON. *Television: The Electronics of Image Transmission*. John Wiley and Sons, Inc.

RCA Receiving Types NOT Recommended

For New Equipment Design

Certain receiving tube types should be avoided in the design of new equipment because they are approaching obsolescence or have limited or dwindling demand. Such RCA Types are listed below:

OZ4-G	2A5*	6D8-G	19	47*
1A4-P	2A6	6F7*	24-A	49
1A6	2A7	6J7-G	25A6*	50
1B4-P	2B7	6J8-G	25Z6*	53
1B5/25S	2E5	6K5-GT	26	55
1C6	3A8-GT	6K7-G	27	56
1C7-G	5T4*	6K8-G	30	57
1D5-GP	5W4*	6L5-G	31	58
1D7-G	5X4-G*	6L7-G	32	59
1E5-GP	5Y4-G*	6P5-GT	32L7-GT	71-A*
1E7-G	6A3	6Q7-G	33	75
1F4	6A4/LA	6S7-G	34	76
1F5-G	6A6	6T7-G	35	77
1F6	6A7	6U7-G	35Z4-GT*	78
1F7-G	6A8-G	6W7-G	36	79
1G5-G	6AC5-GT	6X5*	37	81
1H4-G	6B5	6Z7-G	38	82*
1H6-G	6B6-G	9AP4*	39/44	83-v*
1J5-G	6B7	10	41*	84/6Z4
1J6-GT*	6B8-G	12A7	42*	85
1Q5-GT*	6C6	12AP4*	43*	89
2A4-G*	6D6	15	46*	

**Recently added to this list.*

RCA Preferred Types List

A list of preferred tube types is available to assist equipment designers and manufacturers in formulating their plans for future production of electronic equipment. This list is based on periodic surveys of the needs of the engineering and manufacturing fields and keeps abreast of technological advances in tube design and application.

A copy of this list will be gladly furnished on request. Write to Commercial Engineering, Tube Department, Radio Corporation of America, Harrison, N. J.

