

DAC 21 Diode-triode

The great reduction in filament current has led to the development of a combined detector and A.F.amplifier valve, the DAC 21. At 1.4 V the filament current is only 25 mA (directly heated). In order to attain this very low current consumption, it was necessary to evolve a special technique in the construction of the filament, the second diode generally used for A.G.C.purposes also being dispensed with. The gain factor of the triode section, however, is remarkably high for a battery valve, this being at the same time necessary for adequate sensitivity.

In an R—C coupled circuit the DAC 21 will give a gain of 25 with minimum distortion (with a grid leak on the following valve of 1 MOhm); if it is any higher, say 2 MOhms, the gain will be even greater.

The diode portion is screened from the triode, so that all coupling between the two systems is avoided; the interelectrode capacitance between the diode and the grid and anode of the triode is extremely low.

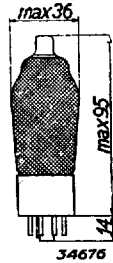

Fig. 1
Dimensions in mm.

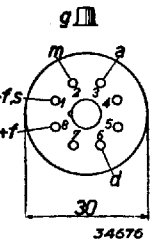
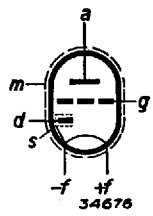

Fig. 2
Arrangement and sequence of contacts.

FILAMENT RATING

Filament feed: direct, by means of battery, rectified alternating current, or D.C.; series or parallel.

Filament voltage $V_f = 1.4$ V
 Filament current $I_f = 0.025$ A

CAPACITANCES

Anode-grid	$C_{ag} = 1.6$	pF
Anode-filament	$C_{af} = 3.3$	pF
Diode-filament	$C_{df} = 2$	pF
Diode-grid	$C_{dg} < 0.0025$	pF
Diode-anode	$C_{da} < 0.1$	pF
Grid-filament	$C_{gf} = 1.6$	pF

TRIODE SECTION RATINGS

Anode voltage	$V_a = 90$	120	V
Grid bias	$V_g = 0$	0	V
Anode current	$I_a = 0.45$	0.75	mA
Gain factor	$\mu = 40$	40	
Mutual conductance	$S = 0.3$	0.4	mA/V
Internal resistance	$R_i = 0.13$	0.1	MOhm

DAC 21

OPERATING DATA: TRIODE SECTION employed as resistance-capacitance coupled A.F. amplifier

Battery voltage	V_b	=	90 V		120 V
Anode feed resistance	R_a	=	0.5 0.2 MOhms	0.5	0.2 MOhm
Grid bias	V_g	=	0 0 V	0	0 V
Anode current	I_a	=	0.081 0.137 mA	0.120	0.225 mA
Required alternating grid voltage for an effective output voltage of V_o eff = 3 V	$V_{i\text{ eff}}$	=	0.132 0.154 V	0.119	0.140 V
Voltage gain	V_o/V_i	=	23 19.5	25	21
Total distortion at an alternating output voltage of V_o eff = 3 V	d_{tot}	=	1.0 1.2 %	0.5	0.7 %

MAXIMUM RATINGS FOR THE TRIODE SECTION

Anode voltage	V_a	= max.	135 V
Anode dissipation	W_a	= max.	0.1 W
Cathode current	I_k	= max.	3 mA
Max. external resistance between grid and filament	R_g	= max.	3 MOhms
Grid current commences ($I_g = +0.3 \mu A$)	V_g	= max.	-0.2 V
Minimum limit for filament voltage	V_f	= min.	1.1 V
Maximum limit for filament voltage	V_f	= max.	1.5 V

MAXIMUM RATINGS FOR THE DIODE SECTION

Peak voltage on the diode	V_d	= max.	125 V
Max. direct current through resistor	I_d	= max.	0.2 mA
Diode current commences	$V_d (I_d = +0.3 \mu A)$	= max.	-0.6 V

APPLICATIONS

The DAC 21 is suitable for diode detection and R—C coupled A.F. amplification. When used in conjunction with other valves in the D-series, this valve makes possible the design of receivers with extremely low current consumption. Since, for economy in current, no diode is provided for automatic gain control, the voltage for this purpose is taken from the detector diode. The filament electrode connected to pin No. 1 (see

Fig. 2) must be earthed, since the diode anode is mounted at that end of the filament, part of the latter of course being used for the diode. In the triode section, the negative end of the filament is slightly positive with respect to the negative filament pin, so that sufficient grid bias is obtained by earthing the grid through a resistance. The valve can thus be operated without any separate source of grid bias.

In view of the very low filament cur-

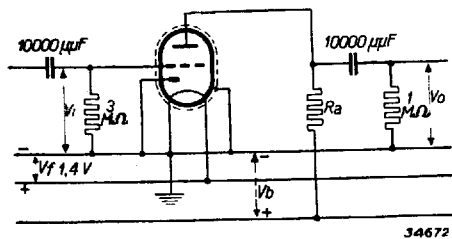

Fig. 3
Skeleton circuit illustrating the symbols employed in the operating data.

rent of the DAC 21, two of these valves can also be used in an A.F. amplifier stage to drive a push-pull output stage: one of them then acts as R—C coupled A.F. amplifier, with the triode part of the other as phase inverter. The two valves together consume only 50 mA filament current and no input transformer is required for the output stage. The filament current of the DBC 21 is also 50 mA, but with this valve an output transformer is necessary for a push-pull output stage. When two DAC 21 valves are employed, two diodes are available, one for detection and the other for A.G.C. Moreover, the combined anode current of the two DAC 21 valves is only 0.2 mA, whilst that of the DBC 21 with transformer coupling is 1.9 mA. The arrangement with two DAC 21 valves in the A.F. driver stage is especially important when the double pentode DLL 21 is used, and Fig. 6 shows a circuit for this combination, in which the anode voltage may be 90—120 V. The triode section of the first DAC 21 operates as a normal A.F. amplifier with R—C coupling and modulates the "left hand" pentode of the DLL 21 across a coupling resistance of 0.5 M Ohm + 25,000 Ohms, with a 10,000 pF condenser.

The alternating grid voltage for the second DAC 21 is taken from the anode resistance of 25,000 Ohms of the first DAC 21, and the anode of the second is coupled to the grid of the "right hand" pentode, but with a phase displacement of 180°.

The filament of the DLL 21 is then connected for a current of 100 mA, since an ordinary dry battery would be too heavily loaded at 200 mA. The sensitivity of the combination, consisting of two DAC 21 and the DLL 21 valves, is about 0.12 V at a high tension voltage of 120 V. Delay voltage for

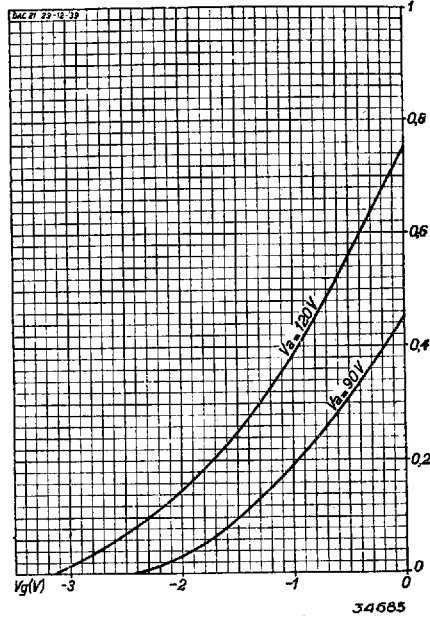

Fig. 4
Anode current as a function of the grid bias at $V_a = 90$ and 120 V.

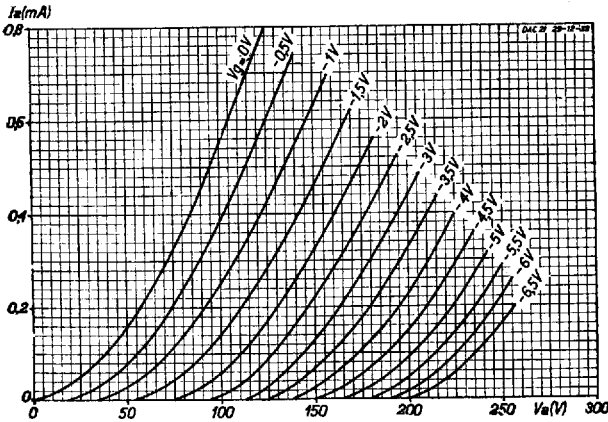

Fig. 5
Anode current as a function of the anode voltage, with V_g as parameter.

the A.G.C. is obtained very simply by applying to the diode of the second DAC 21 a negative potential, obtained automatically from the voltage drop across a resistance in the negative return to the battery. Without signal, this voltage is -1.5 V and

this serves simultaneously as initial voltage for the controlled valves. Naturally, it is possible also to arrange the A.G.C.circuit on other lines, for instance by applying to the controlled valves (mixer and I.F.amplifier) a lower initial voltage and employing a control that is accordingly less effective.

In certain cases it may be desirable to feed the filaments of the valves by means of a good 4.5 V torch battery and this can be done by forming a 50 mA circuit, employing the DK 21 and DL 21 in series with the DAC 21 and DF 21 in parallel: the filament current of the two last mentioned valves is 25 mA, so that overall consumption is 50 mA. Should one of the filament pins fail to make good contact in its valveholder, the filament of the other valve will be heavily overloaded, and although this overload will not usually mean the destruction of the filament, the emission will nevertheless be impaired. The same thing happens when one of the valves is removed without first breaking the filament circuit, and if the arrangement in question is employed the necessary care must be taken that contact between the valve pins and the valveholders is as effective as possible.

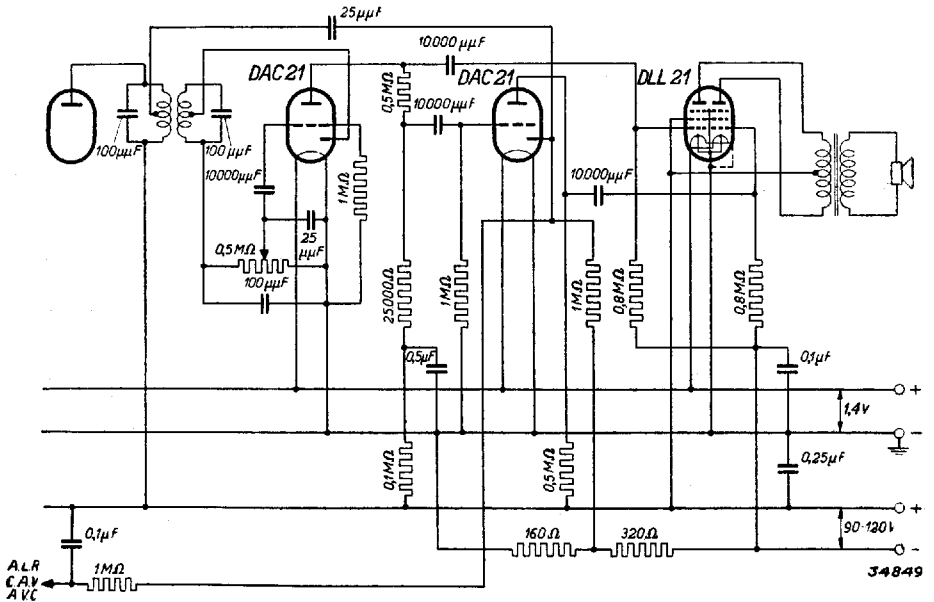

Fig. 6

Theoretical circuit showing method of employing two DAC 21 valves in a modulation stage preceding a push-pull output stage. Detection takes place at the diode of the first DAC 21, the diode of the second DAC 21 serving for the delayed A.G.C.