



# 7262

## VIDICON

Magnetic Focus  
Magnetic Deflection

For Use in Small, Compact Transistorized TV Cameras  
Low-Power (0.6-Watt) Heater  
600-Line Resolution

1"-Diameter Bulb  
5.12" Length

TENTATIVE DATA

RCA-7262 is a small, sturdy camera tube intended primarily for use in small, compact, transistorized television cameras. The use of this type in such cameras--black-and-white or color--is facilitated by its low-power heater which requires only 0.6 watt and its short overall length of only 5-1/8".

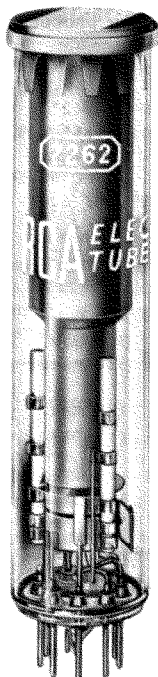

In either live or film pick-up service, the 7262 can provide a picture of high quality for broadcasting or industrial television applications. Its resolution capability is about 600 television lines.

The 7262 utilizes a unique photoconductive surface having uniform thickness which permits constant voltage gradient and uniform dark current across the scanned area. Because of the uniform thickness of its photoconductive surface, the 7262 can produce substantially uniform sensitivity over the entire scanned area. Therefore, the 7262 exhibits a degree of uniformity of characteristics from tube to tube that makes it possible to obtain excellent color uniformity and balance when used in three-vidicon color cameras. While dark current and sensitivity both increase with target voltage, the uniformity of the dark current makes it possible to operate the 7262 at relatively high values of target voltage and dark current. As a result, high effective sensitivity can be obtained with the 7262.

The design of the 7262 utilizes nonmagnetic materials in the front end, an extremely flat faceplate free from optical distortion, and an envelope without a side tip.

Full advantage of the uniformity of the photoconductive layer in the 7262 is realized only when the associated deflecting and focusing components do not introduce scanning-beam landing errors. These errors, if introduced by deflecting and focusing components, can be corrected by applying a modulating voltage of suitable waveform to the cathode, grid No.1, and grid No.2.

### PRINCIPLES OF OPERATION

The structural arrangement of the 7262, shown in Fig.1, consists of a target composed of a transparent conducting film (the signal electrode) on the inner surface of the faceplate and a thin photoconductive layer deposited on the film; a fine mesh screen (grid No.4) located adjacent to the photoconductive layer; a beam-focusing electrode (grid No.3) connected to grid No.4; and an electron gun for producing a beam of electrons.

Each element of the photoconductive layer is an insulator in the dark but becomes slightly conductive when it is illuminated and acts like a leaky capacitor having one plate at the positive potential of the signal electrode and the other floating. When light from the scene or film being televised is focused on the photoconductive-layer surface next to the faceplate, each illuminated layer element conducts slightly depending on the amount of illumination on the element and thus causes the potential of its opposite surface (on the gun side) to rise in less than the time of one frame toward that of the signal-electrode potential. Hence, there appears on the gun side of the entire layer surface a positive potential pattern, composed of the various element potentials, corresponding to the pattern of light imaged on the layer.

The gun side of the photoconductive layer is scanned by a low-velocity electron beam produced by the electron gun. This gun contains a thermionic cathode, a control grid (grid No.1), and an accelerating grid (grid No.2). The beam is focused at the surface of the photoconductive layer by the combined action of the uniform magnetic field of an external coil and the



electrostatic field of grid No.3. Grid No.4 serves to provide a uniform decelerating field between itself and the photoconductive layer so that the electron beam will tend to approach the layer in a direction perpendicular to it-- a condition necessary for driving the surface to cathode potential. The beam electrons approach the layer at low velocity because of the low operating potential of the signal electrode.

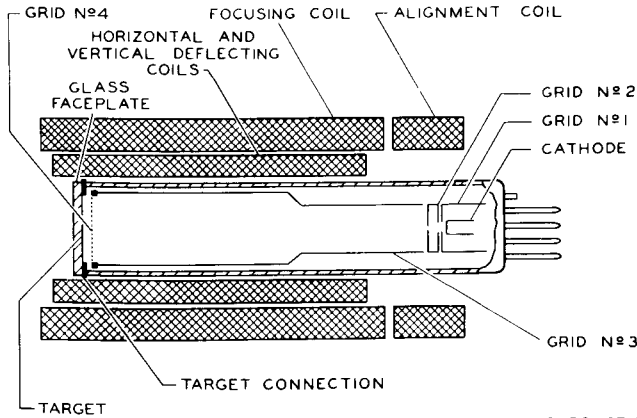

92CS-9767

Fig.1 - Schematic Arrangement of Type 7262.

When the gun side of the photoconductive layer with its positive potential pattern is scanned by the electron beam, electrons are deposited from the beam until the surface potential is reduced to that of the cathode, and thereafter are turned back to form a return beam which is not utilized. Deposition of electrons on the scanned surface of any particular element of the layer causes a change in the difference of potential between the two surfaces of the element. When the two surfaces of the element, which in effect is a charged capacitor, are connected through the external target (signal-electrode) circuit and the scanning beam, a capacitive current is produced and constitutes the video signal. The magnitude of the current is proportional to the surface potential of the element being scanned and to the rate of scan. The video-signal current is then used to develop a signal-output voltage across a load resistor. The signal polarity is such that for highlights in the image, the grid of the first video-amplifier tube swings in a negative direction.

Alignment of the beam is accomplished by a transverse magnetic field produced by external coils located at the base end of the focusing coil.

Deflection of the beam is accomplished by transverse magnetic fields produced by external deflecting coils.

## DATA

### General:

Heater, for Unipotential Cathode:  
 Voltage (AC or DC) . . . . . 6.3 ± 10% volts  
 Current . . . . . 0.095 amp  
 Direct Interelectrode Capacitance: Ⓢ

Target to all other electrodes . . . . . 4.6 μf  
 Spectral Response . . . . . See curves in Fig.12  
 Photoconductive Layer:

Maximum useful diagonal of rectangular image (4 x 3 aspect ratio) . . . . . 0.62 inch

Orientation of quality rectangle--Proper orientation is obtained when the horizontal scan is essentially parallel to the straight sides of the masked portions of the faceplate. The straight sides are parallel to the plane passing through the tube axis and short index pin. The masking is for orientation only and does not define the proper scanned area of the photoconductive layer.

Focusing Method . . . . . Magnetic  
 Deflection Method . . . . . Magnetic  
 Overall Length . . . . . 5.12" ± 0.06"  
 Greatest Diameter . . . . . 1.125" ± 0.010"  
 Bulb . . . . . T8  
 Base . . . . . Small-Button Ditetra 8-Pin (JETEC No.E8-11)  
 Socket . . . . . Cinch No.54A18088<sup>Ⓢ</sup>, or equivalent  
 Operating Position . . . . . Any  
 Weight (Approx.) . . . . . 2 oz

### Maximum Ratings, Absolute Values:

For scanned area of 1/2" x 3/8"

GRID-No.3 & GRID-No.4 VOLTAGE . . . . . 350 max. volts  
 GRID-No.2 VOLTAGE . . . . . 350 max. volts  
 GRID-No.1 VOLTAGE:  
 Negative bias value . . . . . 125 max. volts  
 Positive bias value . . . . . 0 max. volts  
 PEAK HEATER-CATHODE VOLTAGE:  
 Heater negative with respect to cathode . . . . . 125 max. volts  
 Heater positive with respect to cathode . . . . . 10 max. volts  
 DARK CURRENT . . . . . 0.25 max. μa  
 PEAK TARGET CURRENT . . . . . 0.55 max. μa  
 FACEPLATE:  
 Illumination . . . . . 1000 max. ft-c  
 Temperature . . . . . 60 max. °C

### Typical Operation:

For scanned area of 1/2" x 3/8"  
 Faceplate temperature of 30° to 35° C

Grid-No.4 (Decelerator) & Grid-No.3 (Beam-Focus Electrode\*) Voltage . . . . . 250<sup>□</sup> to 300 volts  
 Grid-No.2 (Accelerator) Voltage . . . . . 300 volts  
 Grid-No.1 Voltage for Picture Cutoff . . . . . -45 to -100 volts  
 Average "Gamma" of Transfer Characteristic for signal-output current between 0.02 μa and 0.2 μa . . . . . 0.65  
 Visual Equivalent Signal-to-Noise Ratio (Approx.)<sup>Ⓢ</sup> . . . . . 300:1  
 Minimum Peak-to-Peak Blanking Voltage:  
 When applied to grid No.1 . . . . . 75 volts  
 When applied to cathode . . . . . 20 volts  
 Field Strength at Center of Focusing Coil (Approx.) . . . . . 40 gauss  
 Field Strength of Adjustable Alignment Coil<sup>Ⓢ</sup> . . . . . 0 to 4 gauss

<sup>Ⓢ</sup> Made by Cinch Manufacturing Corporation, 1026 S. Homan Ave., Chicago 24, Illinois.



*Maximum-Sensitivity Operation for Live-Scene Pickup*

Faceplate Illumination (Highlight)	2	ft-c
Max. Target Voltage Required to Produce Dark Current of 0.2 $\mu$ a in Any Tube**	110	volts
Target Voltage†	60 to 100	volts
Dark Current	0.2	$\mu$ a
Target Current (Highlight)■	0.4 to 0.5	$\mu$ a
Signal-Output Current:#		
Peak	0.2 to 0.3	$\mu$ a
Average	0.08 to 0.1	$\mu$ a

*Average-Sensitivity Operation for Live-Scene Pickup*

Faceplate Illumination (Highlight)	15	ft-c
Max. Target Voltage Required to Produce Dark Current of 0.02 $\mu$ a in Any Tube**	60	volts
Target Voltage†	30 to 50	volts
Dark Current	0.02	$\mu$ a
Target Current (Highlight)■	0.3 to 0.4	$\mu$ a
Signal-Output Current:#		
Peak	0.3 to 0.4	$\mu$ a
Average	0.1 to 0.2	$\mu$ a

*Minimum-Lag Operation for Film Pickup*

Faceplate Illumination (Highlight)	100	ft-c
Max. Target Voltage Required to Produce Dark Current of 0.004 $\mu$ a in Any Tube**	30	volts
Target Voltage†	15 to 25	volts
Dark Current	0.004	$\mu$ a
Target Current (Highlight)■	0.3 to 0.4	$\mu$ a
Signal-Output Current:#		
Peak	0.3 to 0.4	$\mu$ a
Average	0.1 to 0.2	$\mu$ a

**OPERATING CONSIDERATIONS**

The *maximum ratings* in the tabulated data are established in accordance with the following definition of the *Absolute-Maximum Rating System* for rating electron devices.

Absolute-Maximum ratings are limiting values of operating and environmental conditions applicable to any electron device of a specified type as defined by its published data, and should not be exceeded under the worst probable conditions.

The device manufacturer chooses these values to provide acceptable serviceability of the device, taking no responsibility for equipment variations, environment variations, and the effects of changes in operating conditions due to variations in device characteristics.

The equipment manufacturer should design so that initially and throughout life no absolute-maximum value for the intended service is exceeded with any device under the worst probable operating conditions with respect to supply-voltage variation, equipment component variation, equipment control adjustment, load variation, signal variation, environmental conditions, and variations in device characteristics.

The *target connection* is made by a suitable spring contact bearing against the edge of the metal ring at the face end of the tube. This spring contact may conveniently be provided as part of the focusing-coil design.

*Support* for the 7262 is provided by a suitable spring-finger suspension at the face end of the tube and by a clamping mechanism near the base end. Orientation of the 7262 in its support should be such that the horizontal scan is essentially parallel to the straight sides of the masked portions of the faceplate. The straight sides are parallel to the plane passing through the tube axis and short index pin.

The *optical system* associated with the 7262 should be of high quality and provide depth of focus sufficient to focus a sharp image on the photoconductive layer.

The *deflecting yoke and focusing coil* should be designed so that no beam landing errors are produced in the 7262. Properly designed yokes and focusing coils will cause the beam to land perpendicularly to the target at all points of the scanned area with resultant superior uniformity of sensitivity and focus over the scanned area.

The yoke should be positioned so that the end of the deflecting coils toward the base of the tube will not extend more than 3-1/2 inches from the faceplate.

The *scanning speed* must be constant in order to obtain good black-level reproduction when the

- This capacitance, which effectively is the output impedance of the 7262, is increased when the tube is mounted in the deflecting-yoke and focusing-coil assembly. The resistive component of the output impedance is in the order of 100 megohms.
- \* Beam focus is obtained by combined effect of grid-No.3 voltage which should be adjustable over indicated range, and a focusing coil having an average field strength of 40 gauss.
- Definition, focus uniformity, and picture quality decrease with decreasing grid-No.4 and grid-No.3 voltage. In general, grid No.4 and grid No.3 should be operated above 250 volts.
- With no blanking voltage on grid No.1.
- ★ Measured with high-gain, low-noise, cascode-input-type amplifier having bandwidth of 5 Mc. Because the noise in such a system is predominately of the high-frequency type, the visual equivalent signal-to-noise ratio is taken as the ratio of the highlight video-signal current to rms noise current, multiplied by a factor of 3.
- ⊕ The alignment coil should be located on the tube so that its center is at a distance of 3-11/16 inches from the face of the tube, and be positioned so that its axis is coincident with the axis of the tube, the deflecting yoke, and the focusing coil.
- † Indicated range for each type of service serves only to illustrate the operating target-voltage range normally encountered.
- \*\* The target voltage for each 7262 must be adjusted to that value which gives the desired operating dark current.
- ▲ The deflecting circuits must provide extremely linear scanning for good black-level reproduction. Dark-current signal is proportional to the scanning velocity. Any change in scanning velocity produces a black-level error in direct proportion to the change in scanning velocity.
- Video amplifiers must be designed properly to handle target currents of this magnitude to avoid amplifier overload or picture distortion.
- # Defined as the component of the target current after the dark-current component has been subtracted.

7262 is operated at high dark current with resultant higher effective sensitivity. The dark-current signal is proportional to the scanning speed. Therefore, any change in scanning speed will produce a nonuniformity in black level in direct proportion to the change in scanning speed.

*Electrostatic shielding* of the target from external fields is required to prevent interference effects in the picture. Effective shielding from the fields produced by the deflecting components is ordinarily provided by grounding a shield on the inside of the faceplate end of the focusing coil and by grounding a shield on the inside of the deflecting yoke at a point near the input of the video amplifier.

The *temperature of the faceplate* should not exceed 60° C (140° F), either during operation or storage of the 7262. Operation with a faceplate temperature in the range from about 25° to 35° C (77° to 99° F) is recommended. The temperature of the faceplate is determined by the combined heating effects of the incident illumination on the faceplate, the associated components, and the tube itself. To reduce these heating effects in film-pickup cameras and permit operation in the preferred temperature range with a high value of illumination, the use of an infrared filter between the projector and faceplate as well as a blast of cooling air directed across the faceplate from a blower is recommended.

The dark current is doubled for every 10° C rise in the temperature of the faceplate, and halved for every 10° C decrease in the temperature of the faceplate. To obtain optimum performance, it is desirable to operate the 7262 at a pre-established value of dark current. Therefore, if the temperature of the faceplate is allowed to vary it will be necessary to adjust the target voltage to maintain the desired dark current, as shown in Fig. 2. Since the sensitivity of the tube decreases with increasing temperature, the amount of faceplate illumination necessary to produce a given signal as a function of faceplate temperature is also shown in Fig. 2. In addition, the lag will decrease with increasing temperature as shown in Fig. 2. For live pickup, it is desirable to select an operating temperature which provides the best balance between lag and sensitivity. The faceplate should be held close to this temperature to assure stability of black level and signal-output level.

The *target voltage* should be obtained from an adjustable dc source. As the target voltage is increased, the dark current increases as shown in Fig. 3. The target voltage must be adjusted to produce the desired value of dark current depending on the type of operation. The target-voltage range of the 7262 for a given value of dark current is small, as shown in Fig. 3. This feature permits utilization of simplified circuits in cameras where automatic change in target voltage is desired to compensate for varying light levels. *It should be noted that individual 7262's will have substantially identical performance characteristics when operated with an identical value of dark current.* For proper adjustment of the target voltage on each 7262, see *sequence of adjustments* on page 9.

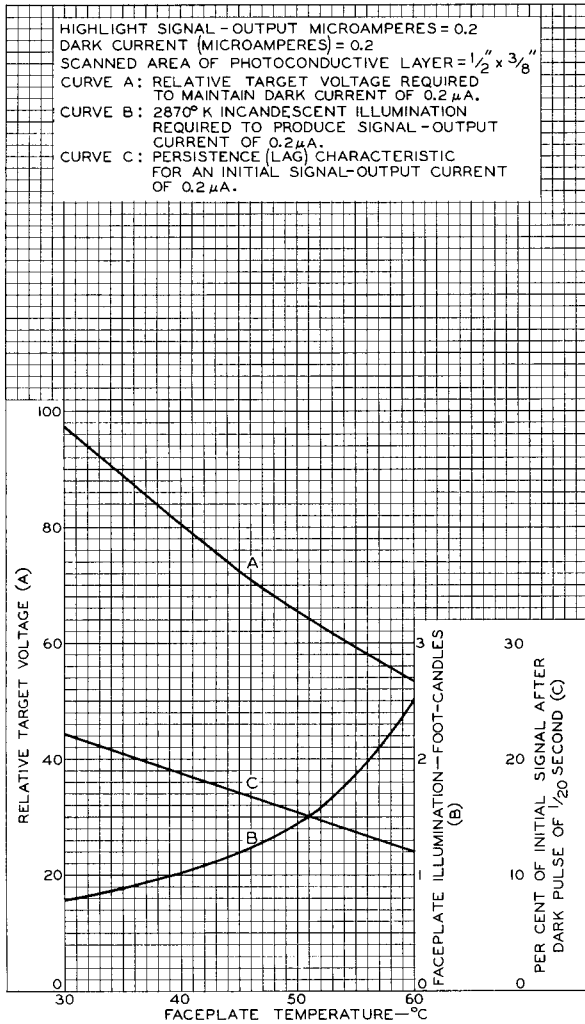

92CM-9499

Fig. 2 - Typical Characteristics of Type 7262.

The polarity of the focusing coil should be such that a north-seeking pole is attracted to the image end of the focusing coil, with the indicator located outside of and at the image end of the focusing coil.

The *alignment coil* should be located on the tube so that its center is at a distance of 3-11/16 inches from the face of the tube, and be positioned so that its axis is coincident with the axis of the tube, the deflecting yoke, and the focusing coil.

The *focusing-electrode (grid-No.3) voltage* may be fixed at a value of about 280 volts when focusing control is obtained by adjusting the current through the focusing coil. In general, resolution decreases with decreasing grid-No.3 voltage. Operation at a grid-No.3 voltage below 250 volts is not recommended. The necessary

The *grid-No.1 supply voltage* should be adjustable from 0 to -110 volts.

The *dc voltages* required by the 7262 can be provided by the circuit shown in Fig.4.

A *blanking signal* should be supplied to grid No.1 or to the cathode to prevent the electron beam from striking the photoconductive layer during the return portions of the horizontal and vertical deflecting cycles. Unless this is done, the camera-tube return lines will appear in the reproduced picture. The blanking signal is a series of negative voltage pulses when it is applied to grid No.1, or a series of positive voltage pulses when it is applied to the cathode.

*Beam intensity* is controlled by the amount of negative voltage on grid No.1. The beam must have adequate intensity to drive the highlight elements of the photoconductive-layer surface to cathode potential on each scan. When the beam has an intensity sufficient only to drive the lowlight elements to cathode potential, the highlight elements are not returned to cathode potential. As a result, the picture highlights all have the same brightness and show no detail. Also, when the beam has insufficient intensity, the photoconductive-layer surface which normally rises in potential by only a small fraction of the signal-electrode potential during each scan, gradually rises in potential to a value approaching nearly the full signal-electrode potential in the highlights. Under this condition, many scans are required to drive to cathode potential any element which has changed from a highlight to a lowlight because of movement of the image. As a result, the highlights tend to "stick". The loss of highlight detail and sticking of the highlights is referred to as "bloom".

On the other hand, a beam with excessively high intensity should not generally be used because the size of the scanning spot increases with resultant decrease in resolution.

The *video amplifier system* should be designed to handle peak ac voltages corresponding to a highlight target current of 0.5 microampere through the target load resistor. Such a system is shown by the block diagram in Fig.5 (a). This system employs a low-noise, cascode preamplifier having an 8-Mc bandwidth as shown in Fig.5 (b).

*Aperture correction* compensates for the aperturing effect of the scanning beam in the 7262. This effect produces a horizontal square-wave response shown by the "uncompensated" curve in Fig.6. When this effect is compensated, the horizontal square-wave response of the video system is raised to approximately 100 per cent over the entire broadcast bandwidth of 4.5 Mc, and is shown by the "compensated" curve in Fig.6. This compensation, however, does not affect the vertical resolution. Combining the

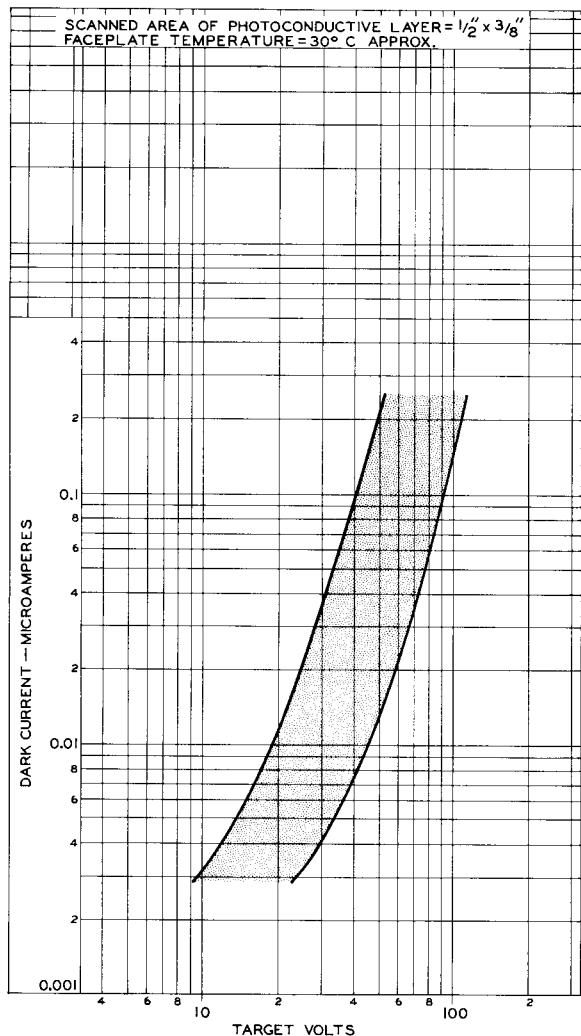

92CM-9497

Fig.3 - Range of Dark Current for Type 7262.

range of current adjustment will depend on the design of the coil, but should be such as to provide a field-strength range of 36 to 44 gauss. When it is desired to use a fixed value of focusing-coil current capable of providing a fixed strength of 40 gauss at the center of the focusing device, the grid-No.3 voltage should be adjustable over a range from 250 to 300 volts.

Definition, focus uniformity, and picture quality decrease with decreasing grid-No.4 and grid-No.3 voltage. In general, grid No.4 and grid No.3 should be operated above 250 volts.

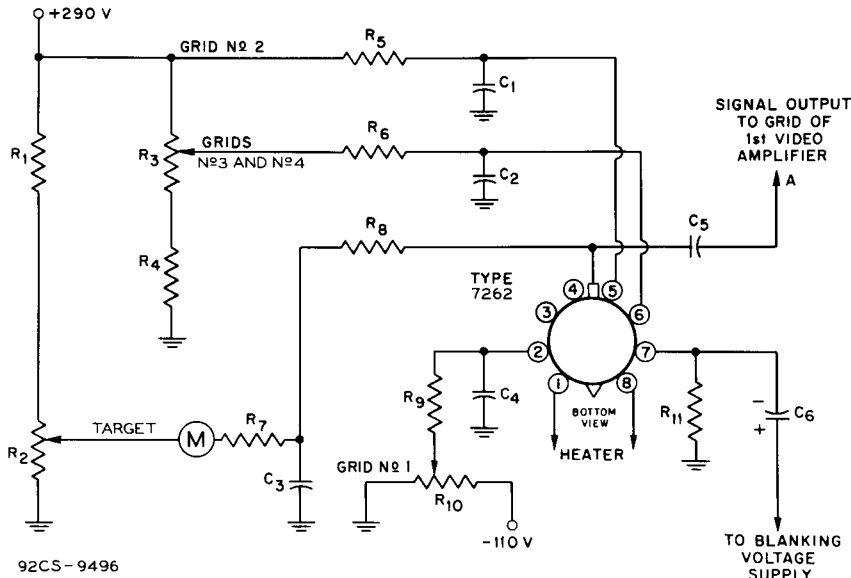

operation of the 7262. For this type of operation, a dark current of 0.2 microampere is required. This value will be obtained for a target voltage within the range of 60 to 100 volts. Under such low-level illumination conditions, the lag will be somewhat greater and the black-level uniformity will be somewhat poorer than for live-pickup conditions with higher faceplate illumination and lower dark current.

When the 7262 is used for live pickup with illumination levels of 10 to 20 foot-candles on the faceplate, a dark current of 0.02 microampere is required. This value will be obtained for a target voltage within the range of 30 to 50 volts.

For film pickup, an average highlight illumination of 50 to 200 foot-candles is required on the faceplate of the 7262 for minimum lag and best black-level uniformity. For this range of illumination, a dark current of about 0.004 microampere is required, and the target voltage will range between 15 and 25 volts.

The exact value of target voltage to give the required dark current will depend on the individual tube and on the temperature at which its faceplate is operated. It is important that the tube be allowed to reach a stable operating temperature before the operating dark current is determined; otherwise the dark current will change as the temperature of the tube changes.

In all cases, the illumination level and/or dark current must be limited or adjusted so that the peak signal-output current does not exceed those values shown under Typical Operation. In order that the signal-output current and dark current will be known at all times, it is recommended that the camera be provided with a suitable microammeter in the target circuit of each 7262 to read average target current, or that a calibration pulse of the proper magnitude be fed into the input of the video preamplifier to indicate peak target currents.

The maximum amount of illumination on the photoconductive layer is limited primarily by the temperature of the faceplate which should never exceed 60° C and should preferably be maintained within the operating range from 25° C to 35° C for most satisfactory performance.

- |   |   |
|---|---|
| C1 C4: 0.1 $\mu$ f, 300 volts (working voltage)                                 | R1: 120000 ohms, 1/2 watt               |
| C2: 0.1 $\mu$ f, 300 volts (working voltage)                                    | R2: 100000-ohm potentiometer, 2 watts   |
| C3 C5: 0.1 $\mu$ f, 200 volts (working voltage)                                 | R3: 50000-ohm potentiometer, 2 watts    |
| C6: 4 $\mu$ f, electrolytic, 300 volts (working voltage)                        | R4: 70000 ohms, 1/2 watt                |
| M: Target-Current Meter, RCA Ultra-sensitive Microammeter WV-84B, or equivalent | R5: 5000 ohms, 1/2 watt                 |
|   | R6: 10000 ohms, 1/2 watt                |
|   | R7: 200000 ohms, 1/2 watt               |
|   | R8: 50000 ohms, 1/2 watt, non-inductive |
|   | R9: 100000 ohms, 1/2 watt               |
|   | R10: 500000-ohm potentiometer, 2 watts  |
|   | R11: 1000 ohms, 1/2 watt, non-inductive |

Fig. 4 - Typical Voltage Dividers for Supplying DC Electrode Voltages to Type 7262.

compensated horizontal resolution and the uncorrected vertical resolution yields the equivalent square-wave response which is shown in Fig. 6 and is expressed by the equation

$$\text{Equiv. Square-Wave Response} = \sqrt{R_v \times R_h}$$

where  $R_v$  and  $R_h$  are the vertical square-wave response and the horizontal square-wave response, respectively.

The illumination incident on the faceplate will range from relatively high values for film pickup to relatively low values for direct pickup. For satisfactory operation of the 7262 at these extremely different light levels, it is essential that the target voltage be properly adjusted with reference to the curves in Figs. 7, 8, and 11 to give the proper value of dark current for the desired service. Adjustment of the target voltage to obtain the desired dark current, is covered in sequence of adjustments on page 9.

For live pickup involving low illumination levels, a good picture can be obtained with a highlight illumination of 1 to 3 foot-candles on the faceplate of the 7262. Such a low illumination level, however, requires maximum-sensitivity



*Signal Output and Light Transfer Characteristics.* Typical signal output as a function of uniform 2870° K tungsten illumination on the photoconductive layer for different values of dark current is shown in Fig.8. It is to be

maintained to insure satisfactory operation of color cameras in which the signal-output currents of the three 7262's must match closely over a wide range of scene illumination. Because its transfer characteristic is approximately the

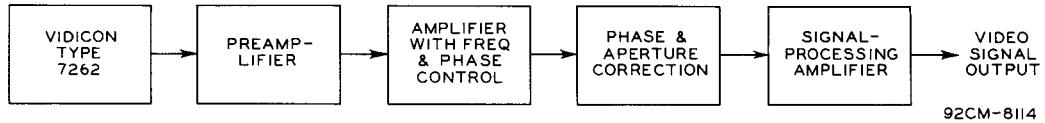
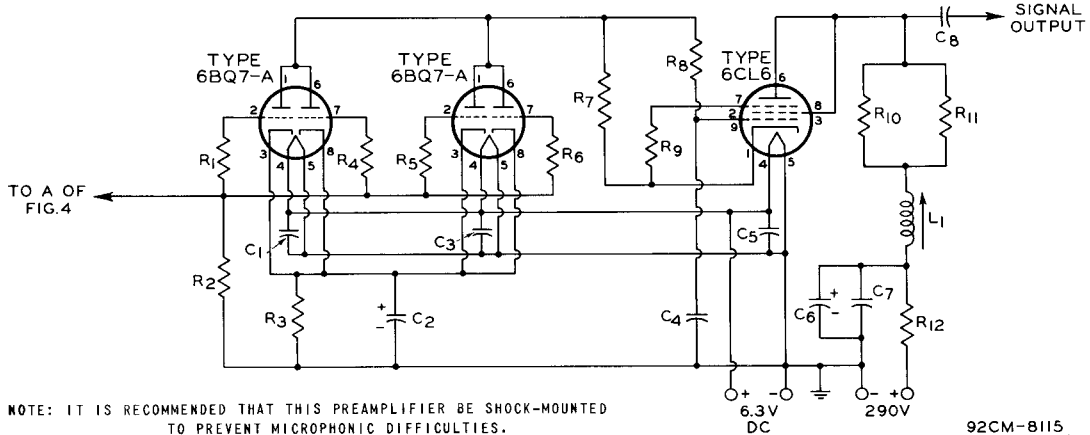

Fig.5 (a) - Block Diagram of Video System.



- All capacitor voltages are working values*
- C1 C3 C5: 0.01  $\mu$ f, 100 volts
  - C2: 2000  $\mu$ f, electrolytic, 3 volts
  - C4: 0.01  $\mu$ f, 350 volts
  - C6: 90  $\mu$ f, electrolytic, 350 volts
  - C7: 0.1  $\mu$ f, 350 volts
  - C8: 0.1  $\mu$ f, 300 volts
  - L1: 12  $\mu$ h peaking coil, adjustable core to cover range from 9 to 15  $\mu$ h

- All resistors are of the carbon-composition type*
- R1 R4 R5 R6: 100 ohms, 1/2 watt
  - R2: 500000 ohms, 1/2 watt
  - R3: 15 ohms, 1/2 watt
  - R7: 12 ohms, 1/2 watt
  - R8: 100000 ohms, 1/2 watt
  - R9: 1 megohm, 1/2 watt
  - R10 R11: 1800 ohms, 2 watts
  - R12: 470 ohms, 2 watts

Fig.5 (b) - Low-Noise Cascode Preamplifier Having 8-Mc Bandwidth.

noted that these curves are for a typical 7262 under the conditions indicated. Because the target voltage needed to give maximum sensitivity at a dark current of 0.2 microampere may range between 60 and 100 volts, it is essential that the best operating target voltage be determined for each 7262. From these curves, it will also be noted that the illumination must be increased about 30 times to produce an increase of 10 times in signal-output current for any given value of dark current.

The average "gamma", or slope, of the light transfer characteristic curves shown in Fig.8 is approximately 0.65. This value is relatively constant over an adjustment range of 4 to 1 in target voltage, or 50 to 1 in dark current, for a signal-output current range between 0.01 and 0.3 microampere. Close uniformity in the value of gamma between individual 7262's is

complement of the transfer characteristic of a picture tube, the 7262 can produce a picture having proper tone rendition.

Because uniformity of sensitivity of the photoconductive layer in the 7262 is excellent, uniform signal output over the scanned area can be obtained if the 7262 is operated with a deflecting-yoke and focusing-coil system designed so that no beam landing errors are produced in the vidicon. If the 7262 is to be utilized with designs of focusing and deflecting systems which introduce such errors, uniform sensitivity over the scanned area of the 7262 can be achieved by compensating for the beam landing errors thus introduced. Without compensation for these errors, variations in sensitivity over the scanned area will occur. These variations resulting from beam landing errors are in the form of lower signal from the edges of the scanned area than

from the center. However, because of the uniformity of the photoconductive layer, these variations in sensitivity are the same from tube to tube. Compensation for the beam landing errors to achieve uniform sensitivity can be obtained by

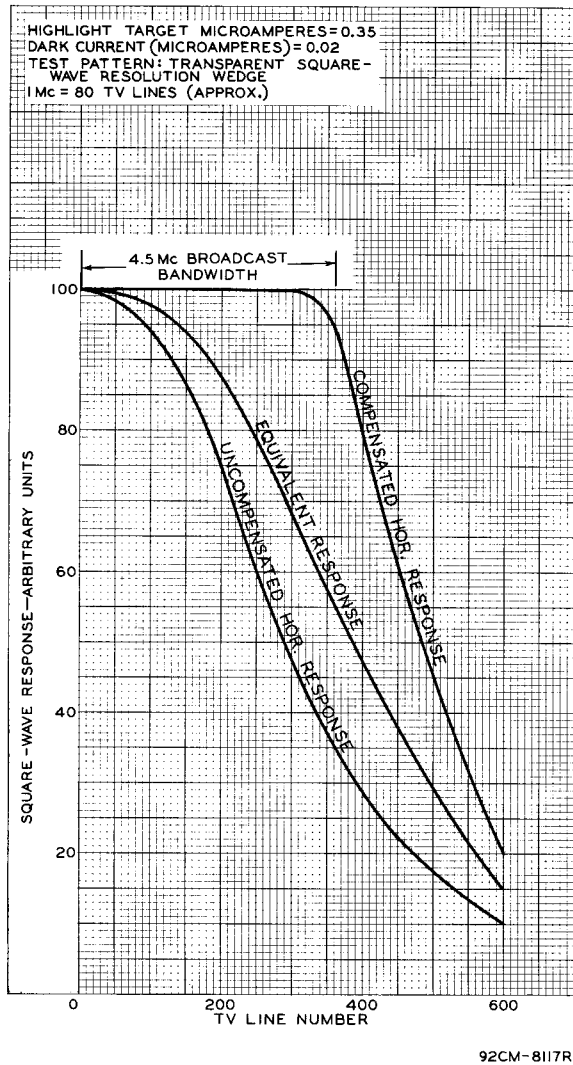

Fig. 6—Curves Showing Uncompensated Horizontal Square-Wave Response of Type 7262 as well as Compensated Horizontal Square-Wave Response and Equivalent Square-Wave Response of the Video System Including Type 7262.

supplying a modulating voltage of a suitable waveform to the cathode of the 7262. The desired waveform is parabolic in shape and of such a polarity that the cathode voltage is lowered as the beam approaches the edges of the scanned area. The modulating waveform should contain parabolic components of both the horizontal and vertical scanning frequencies. The horizontal component should have the greater amplitude and will be the most effective in obtaining uniform sensitivity.

The circuit of Fig. 9 shows the amount of parabolic-waveform voltage required and the method of applying the waveform to the cathode, grid No. 1, and grid No. 2 of a 7262 which utilizes a deflecting-yoke and focusing-coil system that

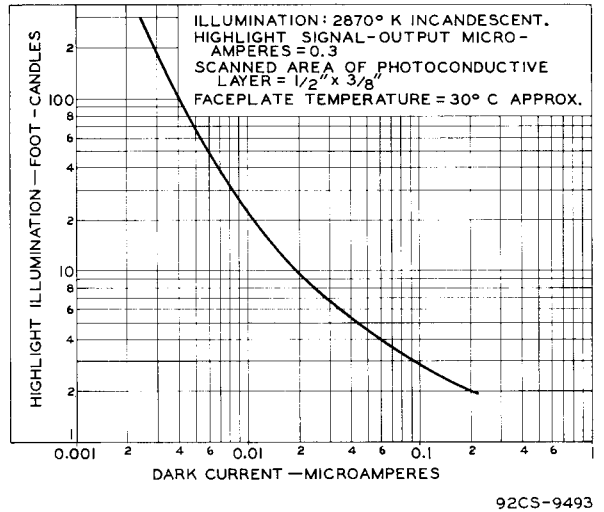

Fig. 7—Typical Characteristic of Type 7262.

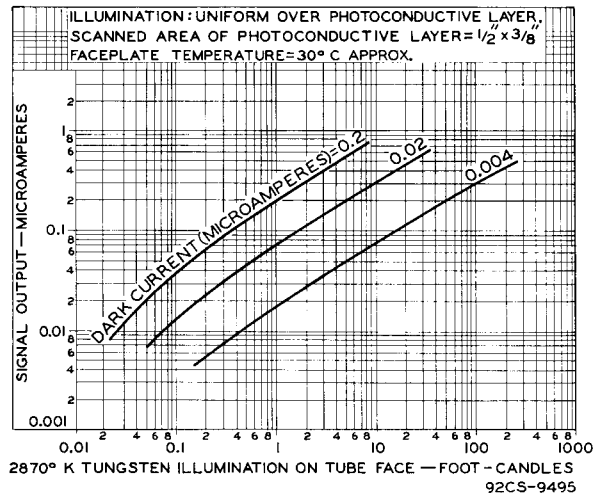

Fig. 8—Light Transfer Characteristics of a Typical 7262 Vidicon.

introduces beam landing errors. The modulating voltage is applied to grid No. 1 and grid No. 2 as well as to the cathode to prevent modulation of the scanning beam.

The use of this modulating waveform also improves the center-to-edge focus of the vidicon and assures that sensitivity over the scanned area will be uniform for the recommended dark current for any specific service. Care must be taken that identical waveforms are applied to



electrodes of each of the three tubes when using the 7262 in 3-vidicon color cameras to insure good registration of all signals over the entire scanned area.

*Persistence* or lag of the photoconductive layer is given in Fig. 10 for two values of dark

*Signal-output-current buildup* when light is applied to the photoconductive layer previously in the dark is as fast or faster than the rate of decay.

The *spectral response* of the 7262 is shown by curves A and C in Fig. 12. Curve A is on the basis of equal values of signal-output current at all wavelengths, whereas curve C is on the basis of equal values of signal-output current with radiant flux from a tungsten source at 2870° K. For comparison purposes, the response of the eye is shown in curve B.

*Full-size scanning of the 1/2" x 3/8" area of the photoconductive layer* should always be used. This condition can be assured by first adjusting the deflection circuits to overscan the photoconductive layer sufficiently so that the edges of the sensitive area can be seen on the monitor. Then, after centering the image on the sensitive area (see Fig. 13), reduce scanning until the edges of the image just disappear. In this way, the maximum signal-to-noise ratio and maximum resolution can be obtained. It should be noted that overscanning the photoconductive layer produces a smaller-than-normal picture on the monitor.

*Underscanning of the photoconductive layer*, i.e., scanning an area of the layer less than 1/2" x 3/8", should never be permitted. This condition which produces a larger-than-normal picture on the monitor, not only causes sacrifice in signal-to-noise ratio and resolution, but also may cause permanent change in sensitivity and dark current of the underscanned area. An underscanned area showing such a change will be visible in the picture when full-size scanning is restored.

*Failure of scanning* even for a few seconds may permanently damage the photoconductive layer. The damaged area shows up as a spot or line in the picture during subsequent operation. To avoid damaging the 7262 during scanning failure, it is necessary to prevent the scanning beam from reaching the layer. The scanning beam can conveniently be prevented from reaching the layer by increasing the grid-No. 1 voltage to cutoff.

The *sequence of adjustments* in operating the 7262 for live pickup is as follows: With the Grid-No. 1 Voltage Control set for maximum negative bias (beam cutoff), Target Voltage Control set for the minimum voltage shown under *Typical Operation*, and Deflection Controls set for maximum overscan, apply other voltages to the 7262 as indicated under *Typical Operation*.

Next, with a 1/2" x 3/8" mask centered on the face of the tube, and with the iris set for minimum opening, decrease the grid-No. 1 bias to just bring out the highlight details of the picture on the monitor. Adjust the Beam-Focus Voltage Control, the lens stop, and the optical

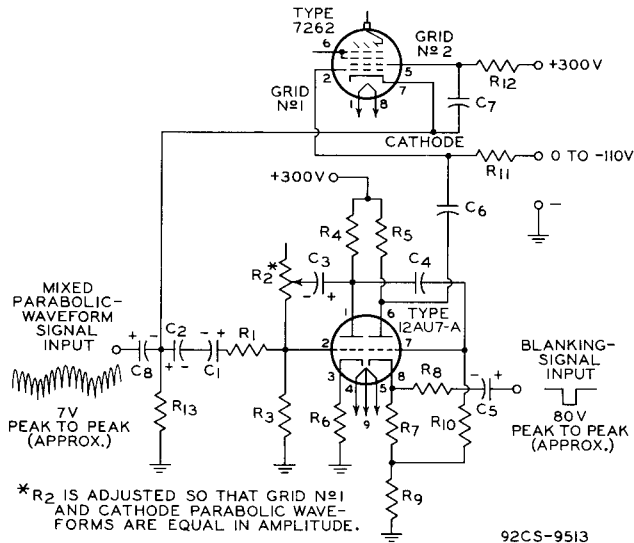

All capacitor voltages are working values

C1: 8 $\mu$ f, electrolytic,	25 volts	C5: 8 $\mu$ f, electrolytic,	450 volts
C3: 8 $\mu$ f, electrolytic,	450 volts	C6: 1 $\mu$ f, paper tubular,	400 volts
C4: 0.1 $\mu$ f, paper tubular,	400 volts	C7: 30 $\mu$ f, electrolytic,	450 volts
C8: 125 $\mu$ f, electrolytic,	350 volts		

All resistors are of the carbon-composition type

R1: 10000 ohms, 1/2 watt	R7: 1800 ohms, 1/2 watt
R2: 50000 ohm-poten- tiometer, linear taper	R8: 10000 ohms, 1/2 watt
R3: 1 megohm, 1/2 watt	R9: 8200 ohms, 1 watt
R4: 20000 ohms, 1 watt	R10: 1 megohm, 1/2 watt
R5: 10000 ohms, 1 watt	R11: 100000 ohms, 1/2 watt
R6: 1000 ohms, 1/2 watt	R12: 5100 ohms, 1/2 watt
	R13: 1000 ohms, 1/2 watt

Fig. 9 - Typical Circuit for Applying Waveform to Compensate for Beam Landing Errors in Type 7262.

current. Each curve shows the decay in signal-output current from an initial value of 0.3 microampere after the illumination is cut off. The effect of faceplate temperature on persistence is shown in Fig. 2.

Persistence of the photoconductive layer for different values of dark current is given by the curve in Fig. 11. It is to be noted that the initial signal-output current is held constant for each value of dark current. This curve shows decreasing lag with decreasing dark current, and a small value of lag for the low value of dark current recommended for film pickup.

focus to obtain the best picture. Reduce horizontal and vertical scanning so that the edges of the image extend just outside the scanned area on the monitor. Then adjust the alignment field so that the center of the picture does not

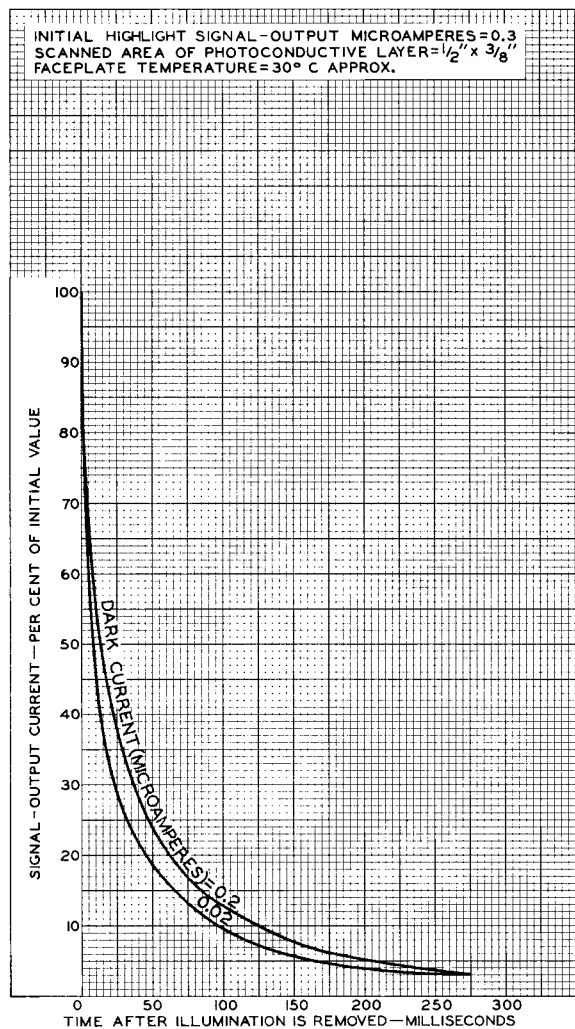

92CM-9505

Fig.10 - Typical Persistence Characteristics of Type 7262.

move as the beam-focus voltage is varied. Some readjustment of horizontal and vertical centering may be necessary after alignment.

For maximum-sensitivity operation of the 7262 in live-pickup service, proceed as follows: With no illumination on the face of the tube, increase the target voltage until a dark current of 0.2 microampere is measured. The current should be measured with a sensitive microammeter such as the RCA Type WV-84B Microammeter.

Next, open the lens and adjust the aperture to give a peak signal-output current of 0.2 to 0.3 microampere. A good procedure for doing this is to focus the camera on a uniform white area having the same brightness as the highlights in the scene to be televised. The image of this white area must at least cover the scanned area of the tube face. The current read on the microammeter will be the dark current plus the peak signal-output current, i.e., highlight target current.

A waveform-oscilloscope monitor can be used to compare the peak signal-output current produced by any scene to the peak value measured with the microammeter when the camera is focused on a uniformly bright scene. When a camera is

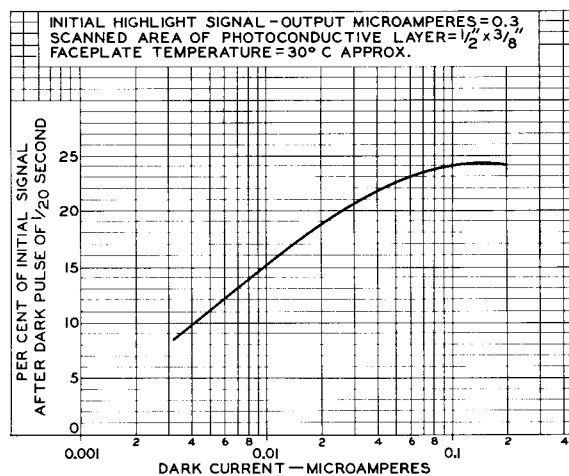

92CS-9504

Fig.11 - Typical Persistence Characteristic of Type 7262.

adjusted in this manner, video gain should be kept constant and the light level on the tube face should be controlled to maintain the constant predetermined value of peak signal as observed on the oscilloscope.

After adjusting the light level to obtain the correct signal-output current, the grid-No.1-bias voltage should be adjusted to just discharge the highlights. Too much current will result in poor resolution and poor picture quality. After the grid-No.1 bias is properly adjusted, it will be necessary to check and readjust the dark current and the peak signal-output current.

Proper adjustment of the dark current, the peak signal-output current, and the grid-No.1 bias, will result in a picture of good quality with minimum smearing of moving objects.

For average-sensitivity operation of the 7262 in live-pickup service, the adjustments are



similar to those for maximum-sensitivity operation except that the target voltage should be adjusted to produce a dark current of 0.02 microampere. When sufficient light is available, decreased lag can be obtained by operating with this lower value of dark current.

For film-pickup operation of the 7262, the adjustments will be similar to those for live

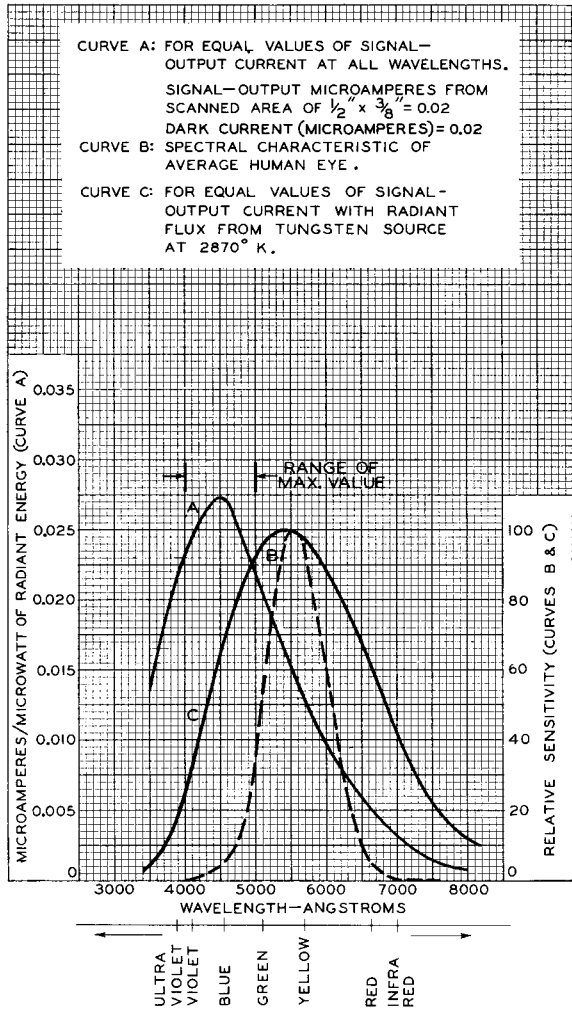

Fig. 12 - Spectral Sensitivity Characteristics of Type 7262.

pickup except that the target voltage should be adjusted to produce a dark current of 0.004 microampere and the peak signal-output current should be adjusted to the desired value by controlling the light level on the faceplate of the tube.

In setting up three 7262's in a color camera, particular attention must be given to proper alignment, best obtainable focus, and identical centering of scanned areas on the photoconductive layers. For best color balance and color tracking over a wide range of light levels, the light level in each color channel should be controlled

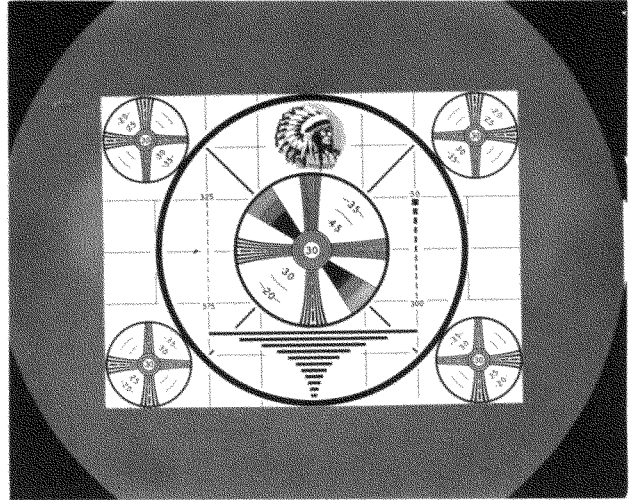

Fig. 13 - Illustration Showing Proper Positioning of Image on the Face of the Vidicon.

so that each of the three 7262's develops the same value of peak signal output for white portions of a scene. Observation of these operating conditions will assure good registration and good color balance.

## REFERENCES

- Otto H. Schade, "Electro-Optical Characteristics of Television Systems; Introduction and
- "Part I -- Characteristics of Vision and Visual Systems," RCA Review, March, 1948;
- "Part II -- Electro-Optical Specifications for Television Systems," RCA Review, June, 1948.
- "Part III -- Electro-Optical Characteristics of Camera Systems," RCA Review, September, 1948.
- "Part IV -- Correlation and Evaluation of Electro-Optical Characteristics of Imaging Systems," RCA Review, December, 1948.
- R. G. Neuhauser, "Vidicon for Film Pickup," Jour. of S.M.P.T.E., Vol. 62, No. 2, February, 1954.
- H. N. Kozanowski, "Vidicon Film-Reproduction Cameras," Jour. of S.M.P.T.E., Vol. 62, February, 1954.
- H. N. Kozanowski, "3-Vidicon Color Film Camera," Broadcast News, No. 79, May-June, 1954.
- R. G. Neuhauser and L. D. Miller, "Beam-Landing Errors and Signal-Output Uniformity of Vidicons," Jour. of S.M.P.T.E., Vol. 67, March, 1958.
- L. D. Miller and B. H. Vine, "An Improved Developmental One-Inch Vidicon for Television Cameras," Jour. of S.M.P.T.E., Vol. 67, March, 1958.



### DIMENSIONAL OUTLINE

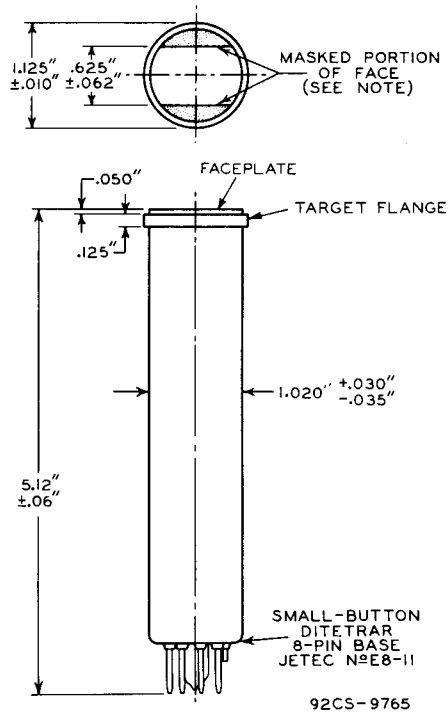

**NOTE:** STRAIGHT SIDES OF MASKED PORTIONS ARE PARALLEL TO THE PLANE PASSING THROUGH TUBE AXIS AND SHORT INDEX PIN.

### SOCKET CONNECTIONS Bottom View

- PIN 1: HEATER
- PIN 2: GRID No.1
- PIN 3: INTERNAL CONNECTION--- DO NOT USE
- PIN 4: INTERNAL CONNECTION--- DO NOT USE
- PIN 5: GRID No.2
- PIN 6: GRIDS No.3 and No.4

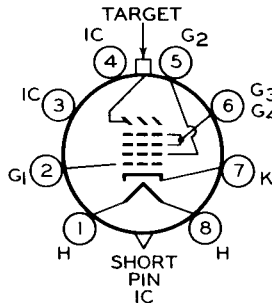

- PIN 7: CATHODE
- PIN 8: HEATER
- FLANGE: TARGET
- SHORT INDEX PIN: INTERNAL CONNECTION--- MAKE NO CONNECTION

DIRECTION OF LIGHT:  
INTO FACE END OF TUBE

8HM

Devices and arrangements shown or described herein may use patents of RCA or others. Information contained herein is furnished without responsibility by RCA for its use and without prejudice to RCA's patent rights.