

*doing new jobs  
everywhere in  
electronics*

# SYLVANIA DECADE COUNTER TUBES

Sylvania Decade counter tubes are growing in importance in the electronics industry due to their wide range of applications, including

COMPUTERS AND TABULATING MACHINES  
MACHINE CONTROLS  
COUNTER DEVICES AND SCALERS  
RADIATION MEASURING EQUIPMENT  
TIMING DEVICES

*The tubes will perform all of these varied functions:*

DISTRIBUTING	CODING	MATRIXING
SAMPLING	MODULATING	INDEXING
FREQUENCY DIVIDING	COMMUTATING	MULTIPLEXING

The new high speed tubes, types 6909, 6910, and the miniature 7155, are designed to operate at frequencies up to 100 kilocycles per second. All of Sylvania's decade counter tubes offer these advantages:

1. high reliability
2. electrical and direct visual readout with bright neon glow
3. negligible power dissipation
4. short resolution time
5. simple, low cost circuitry
6. no moving parts

On the following pages you will find complete technical information on the Sylvania line of cold cathode decade counter tubes.



## principles of operation

The Sylvania decade counter (glow transfer) tube is a gas-filled device employing 30 pin-like cathodes which surround a disc-shaped anode. The cathodes are identical physically but are electrically connected in three groups, called guide 1 buss, guide 2 buss, and output cathode buss. Conduction occurs in the tube between the anode and the most negative cathode pin, causing a glow on the tip of the pin which permits direct visual read-out, and electrical read-out in the form of voltage developing across a cathode load.

In operation, a negative input pulse is applied to the guide 1 buss, which causes the glow to move from a cathode (the quiescent position) to the nearest guide 1 pin. Near the end of the first input pulse, a second input pulse is applied to guide 2, making it the most negative pin and causing the glow to shift there. Since the guide pins are normally positive with respect to the cathodes, removal of the input pulse from guide 2 causes the glow to move to the nearest cathode, thus completing one counting cycle.

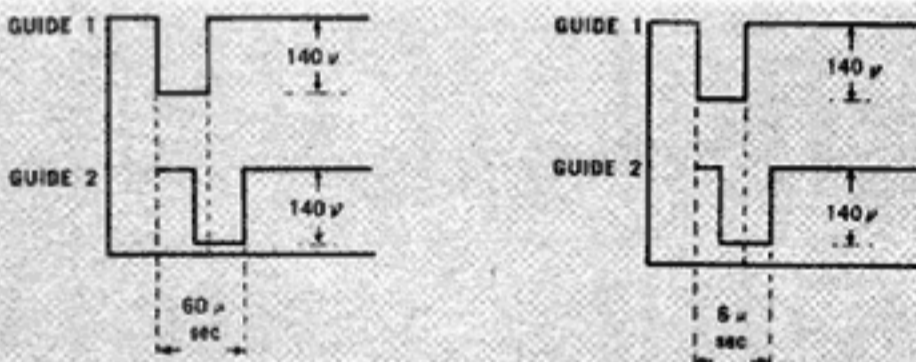

**FIG. 1**  
Idealized Waveforms on Adjacent Guides, Medium Speed Tubes. Pulse widths are 30 to 40  $\mu$ s min. Overlap is 10  $\mu$ s min.

**FIG. 2**  
Idealized Waveforms on Adjacent Guides, High Speed Tubes. Pulse width are 4  $\mu$ s min. Overlap is 2  $\mu$ s min.

## resetting

Usually, it is a requirement of the equipment that counting starts from a particular initial cathode, and that upon completion of a counting period, the glow be returned to the reference, or zero cathode. This may be accomplished either by opening the negative connection of all cathodes and guides except the zero cathode, or by pulsing the zero cathode negative. In either case, the zero cathode becomes 120 volts or more negative with respect to all other pins, for 50 microseconds or longer in the medium speed tubes and for 2 microseconds or longer in the higher speed tubes.

The maximum pulse duration for the reset pulse is limited by the operating frequency. Commonly, the reset action is made to occur slowly, with a wide reset pulse, but in certain applications it may become necessary to reset the glow rapidly to a reference cathode to avoid loss of count during the resetting operation. Therefore, the reset pulse-width in this case should be consistent with the speed at which the counted signal is being received from the drivers.

When several tubes are cascaded, it is recommended that resetting be made to the zero cathode in the first stage, and the number 9 cathode in succeeding stages. This is to absorb the counting pulse which is passed to the other tubes when the first tube is reset.

## phase relationships

Proper timing of the ignition and extinction of adjacent guides is the key to reliable operation. Four steps must occur in order: ignition of guide 1, ignition of guide 2, extinction of guide 1, and extinction of guide 2. This is shown by the voltage waves in Figures 1 and 2, the values of 1 being for medium speed tubes and those of 2 for high speed tubes. Note that in order to satisfy the basic requirement, an overlap of guide pulses is necessary. The minimum overlap is 10 microseconds for the medium speed tube and 2 microseconds for the high speed tube.

The idealized waveforms of figures 1 and 2 are encountered only in test equipment; waveforms similar to those of Figure 3 are more common. Here, not only is the overlap time of importance, but also the time between leading edges, and the time between trailing edges. The minimum value of overlap is 10 microseconds for the medium speed tube, and 2 microseconds for the high speed. These are also the minimums for the time between leading edges, and the time between trailing edges.

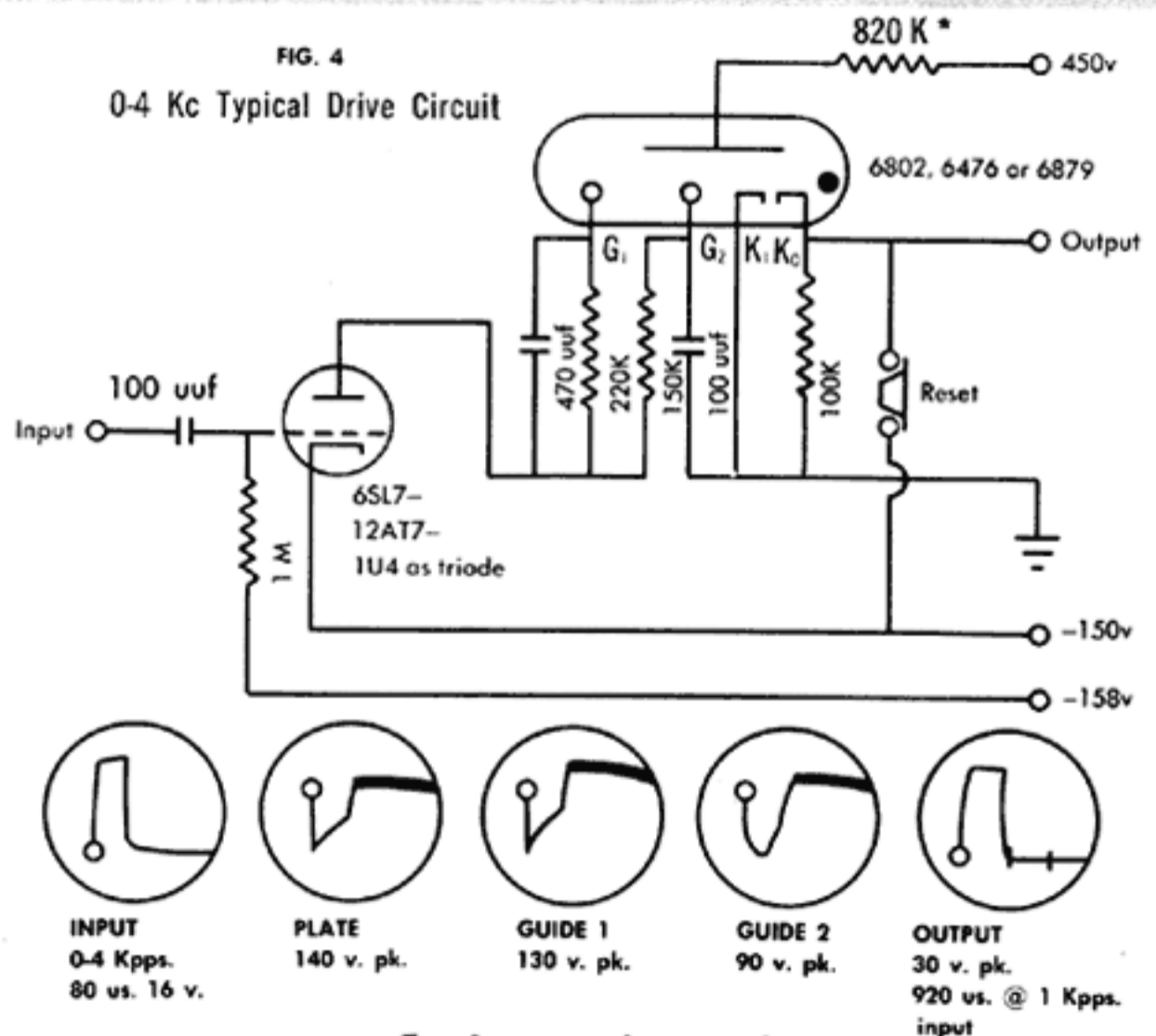
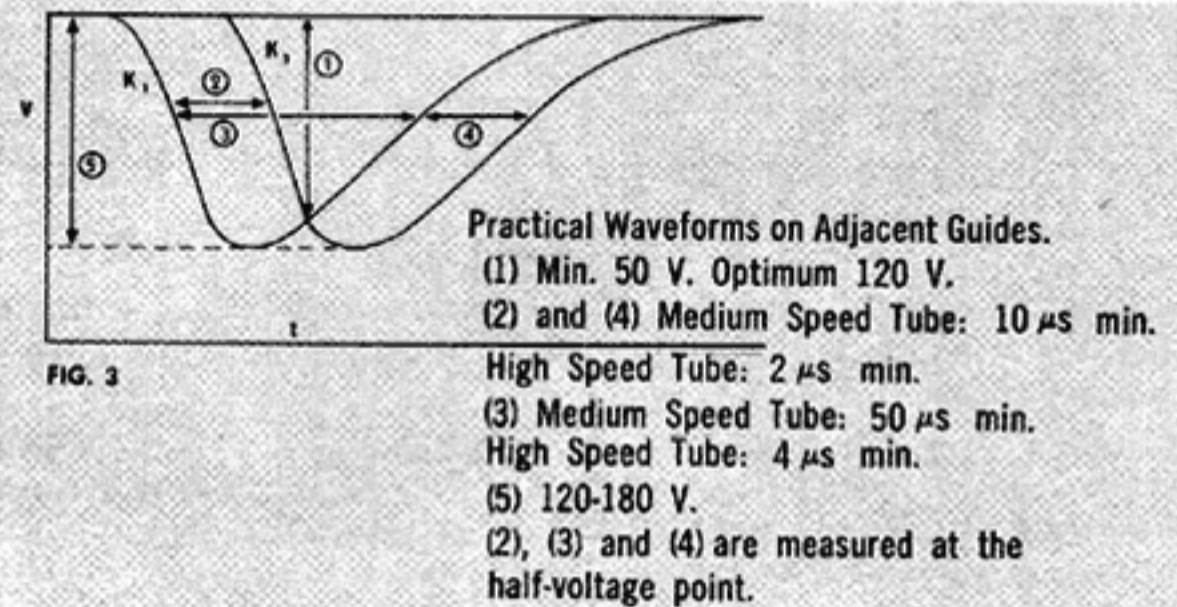

## drive circuits

0-4 Kc—The circuit of Figure 4 employs a minimum number of components for use with the medium speed (4 Kc) tubes, types 6476, 6476A, 6802 and 6879. It gives excellent, reliable response from slow random pulses and up to 4000 pulses per (cont'd on Page 4)

(cont'd from Page 3)

second, especially where the information pulse has a short rise time but is otherwise not an ideal square wave. With a sin wave or other inputs not exhibiting a short rise time, upward adjustment of capacitance values in the input and the time delay RC network will insure more reliable operation at frequencies below 500 cps. Generally, high reliability will be achieved with this circuit if the pulse supplied to the guides has sharp rate of rise and sufficient amplitude and width, as indicated.

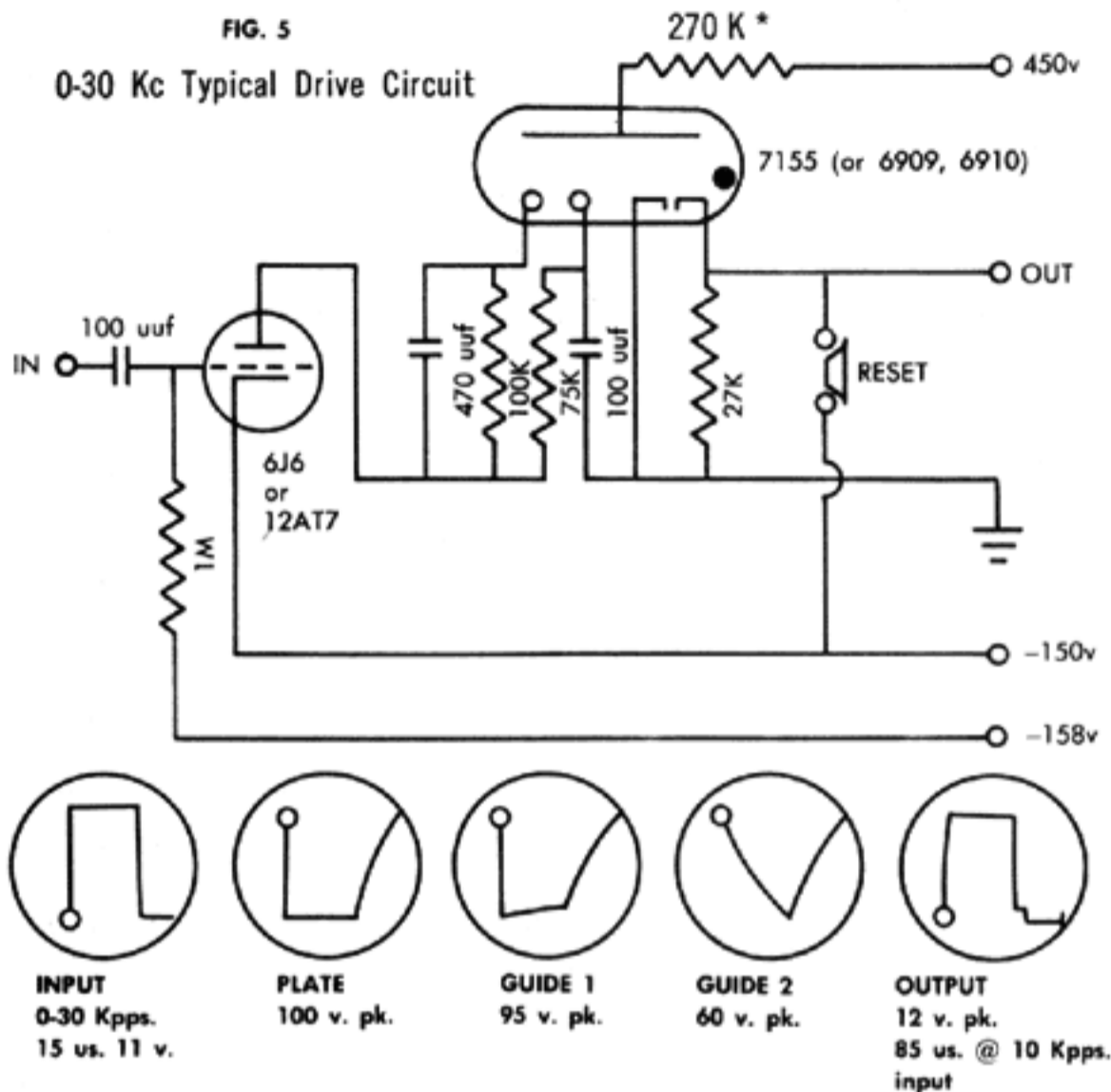

0-30 Kc—This circuit (Figure 5) is designed for the high speed tubes, types 6909, 6910 and 7155, in applications where speeds over 30 Kc will not be encountered.

0-100 Kc—Figure 6 gives a typical circuit for use with the high speed tubes, types 6909, 6910 and 7155, at any counting rate between 0 and 100 Kc. In the 50 to 100 Kc range the variable plate resistor should be adjusted for best operation.

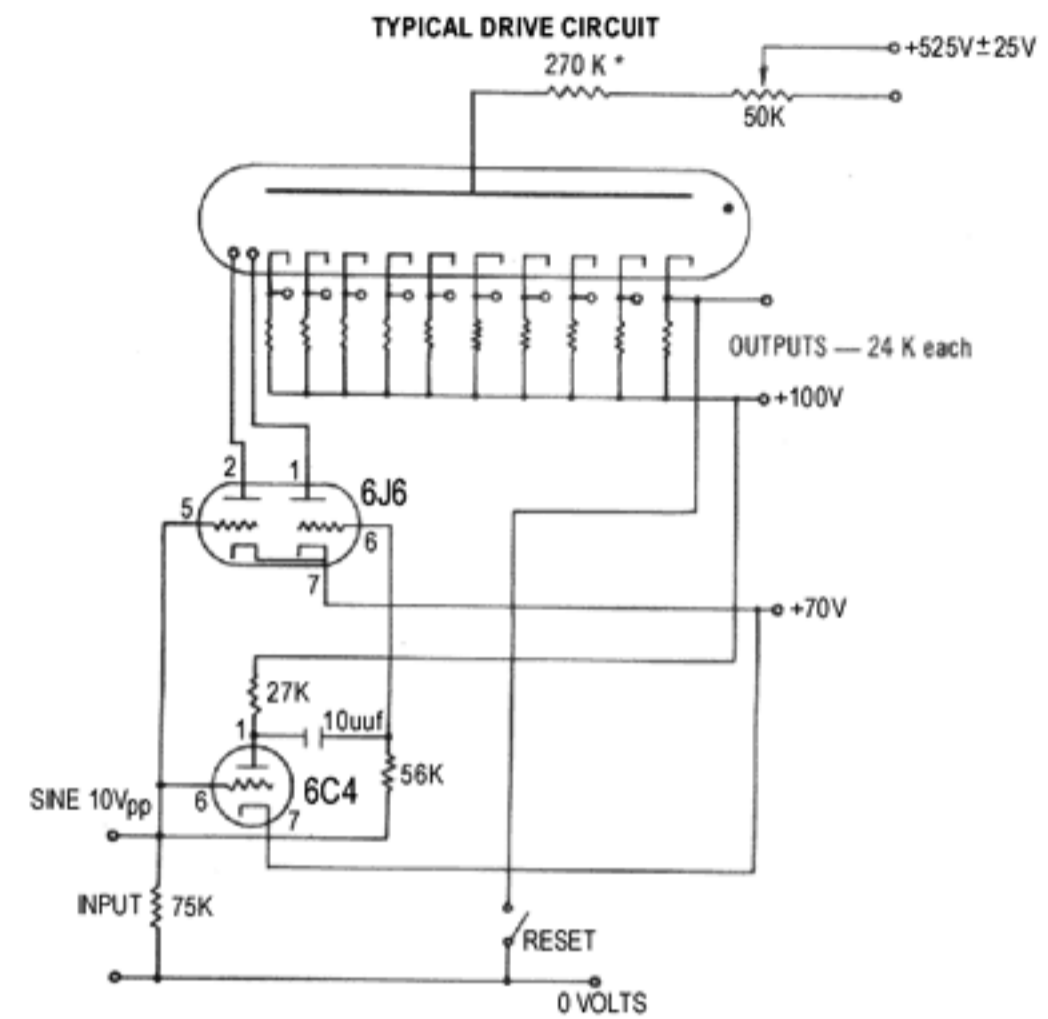

\*Locate anode resistor within 1/2" of anode pin.

## 100 KC. 4 OUTPUT CATHODES. T5 1/2 BULB

# 7155

### MECHANICAL DATA

Mounting Position . . . . .	Any
Zero Position (Cathode No. 10) . . . . .	Aligned with Pin No. 5 ±10°
Bulb . . . . .	T5 1/2
Base . . . . .	7-pin

### ELECTRICAL DATA

#### RATINGS (Absolute Values)

Total Anode Current . . . . .	1.2 Ma max.
Voltage Between Electrodes (other than anode) . . . . .	140 Volts max.
Supply Voltage (anode to cathode) . . . . .	425 Volts min.
Input Frequency . . . . .	100,000 P.P.S. max.

#### TYPICAL OPERATION

DC Supply Voltage . . . . .	450 Volts
Anode Resistor . . . . .	0.27 Megohms
Nominal Tube Drop (under these conditions) . . . . .	235 Volts
Cathode Resistor . . . . .	27 Kohms
Output Voltage (developed across cathode resistor) . . . . .	12 Volts

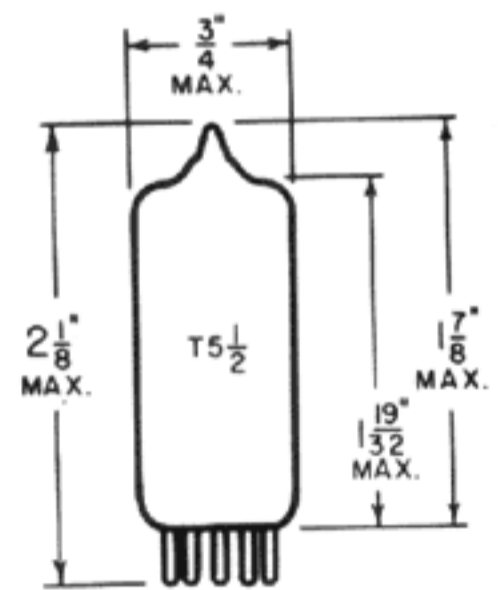
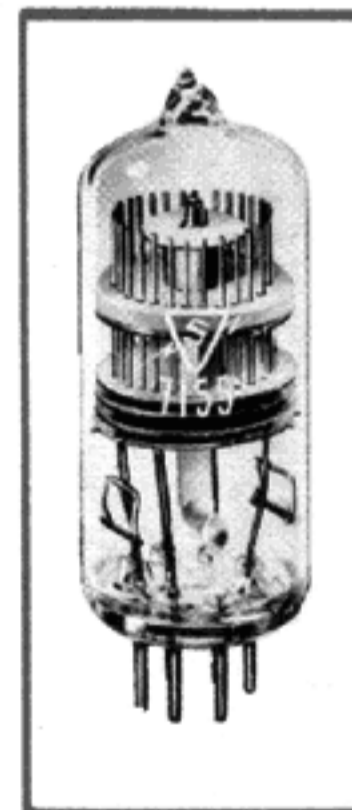

Outline Drawing

- Pin No. 1 Cathode No. 8
- Pin No. 2 Guide No. 1
- Pin No. 3 Common Cathode
- Pin No. 4 Guide No. 2
- Pin No. 5 Cathode No. 0
- Pin No. 6 Cathode No. 9
- Pin No. 7 Anode

# 6476-6476A

## 4 KC. 10 OUTPUT CATHODES. T11 BULB

### MECHANICAL DATA

Mounting Position . . . . . Any  
 (Count is read from top of tube)  
 Zero Position (Cathode No. 10) . . . Aligned with pin No. 12  $\pm 10^\circ$   
 Bulb . . . . . T11  
 Base . . . . . Modified Duo-decal\*

\*Part No. 7460-0008, available from Sylvania Parts Div., Warren, Pa.

### ELECTRICAL DATA

#### RATINGS (Absolute Values)

Total Anode Current . . . . .	0.60 Ma	max.
Voltage Between Electrodes (other than anode)		
6476 . . . . .	140 Volts	max.
6476A . . . . .	200 Volts	max.
Supply Voltage (anode to cathode) . . . . .	350 Volts	min.
Input Frequency . . . . .	4,000 P.P.S.	max.

#### TYPICAL OPERATION

DC Supply Voltage . . . . .	400-450 Volts
Anode Resistor . . . . .	0.82 Megohms
Nominal Tube Drop (under these conditions) . . . . .	191 Volts
Cathode Resistor . . . . .	100 Kohms
Output Voltage (developed across cathode resistor) . . . . .	30 Volts

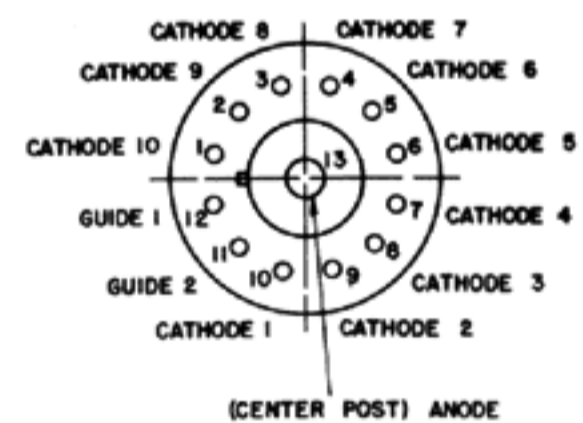
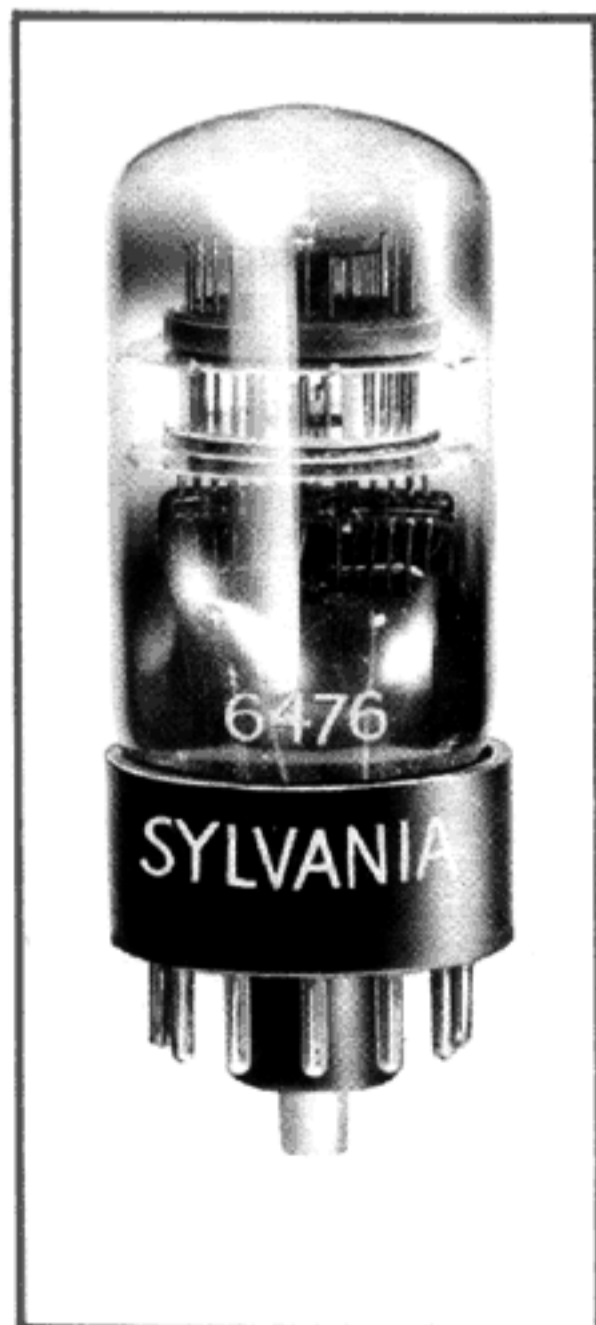
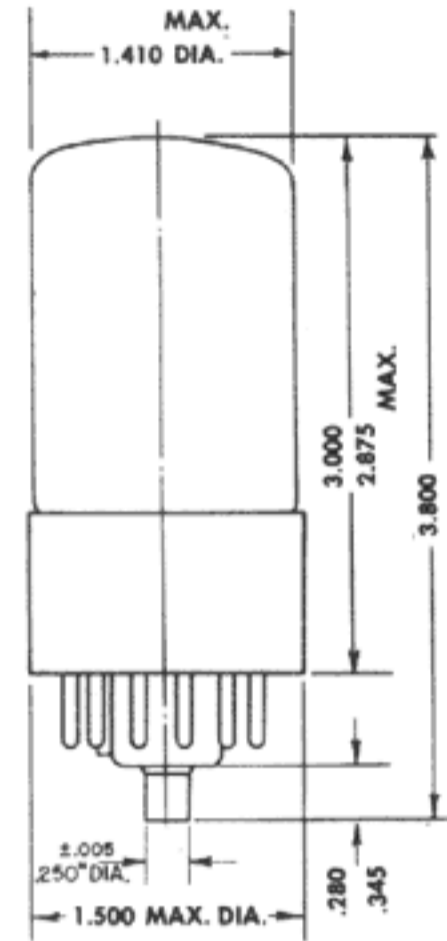

6476 and 6476A  
Base Connections

**4 KC. 4 OUTPUT CATHODES. T9 BULB**

**6802**

**MECHANICAL DATA**

Mounting Position . . . . . Any  
 (Count is read from top of tube)  
 Zero Position (Cathode No. 10) . . . Aligned with pin No. 6  $\pm 10^\circ$   
 Bulb . . . . . T9  
 Base . . . . . Octal

**ELECTRICAL DATA**

**RATINGS (Absolute Values)**

Total Anode Current . . . . . 0.60 Ma max.  
 Voltage Between Electrodes  
 (other than anode) . . . . . 140 Volts max.  
 Supply Voltage (anode to cathode) . . . . . 350 Volts min.  
 Input Frequency . . . . . 4,000 P.P.S. max.

**TYPICAL OPERATION**

Supply Voltage . . . . . 425 Volts  
 Anode Resistor . . . . . 0.82 Megohms  
 Nominal Tube Drop  
 (under these conditions) . . . . . 195 Volts  
 Cathode Resistor . . . . . 100 Kohms  
 Output Voltage  
 (developed across cathode resistor) . . . . . 30 Volts

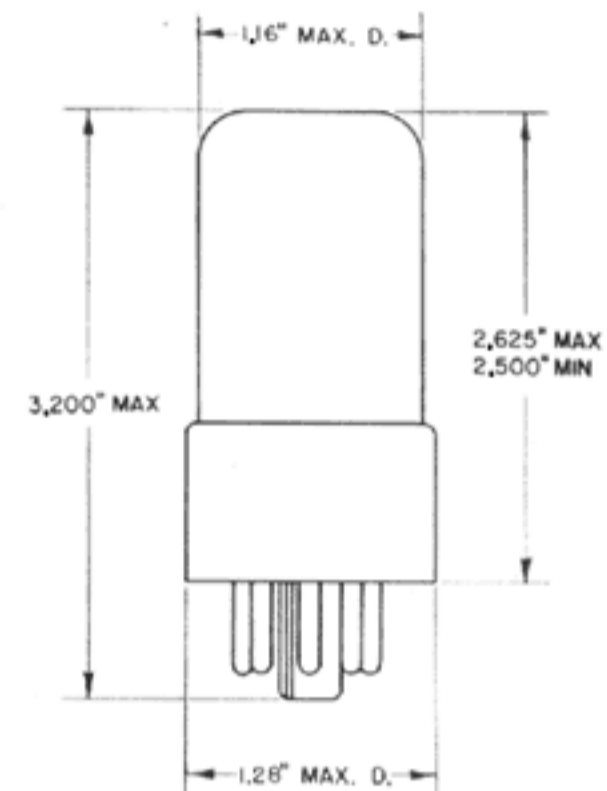

**Outline Drawing**

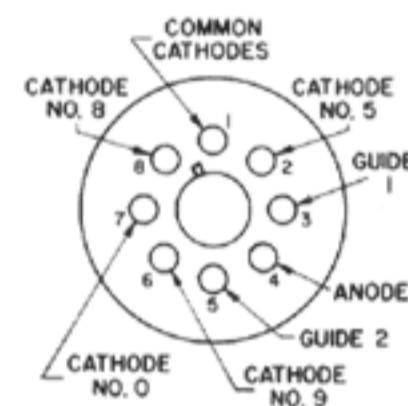

**Base Connections**

**5 KC. 3 OUTPUT CATHODES. T5 1/2 BULB**

**6879**

**MECHANICAL DATA**

Mounting Position . . . . . Any  
 (Count is read from top of tube)  
 Zero Position (Cathode No. 10) . . . Aligned with pin No. 5  $\pm 10^\circ$   
 Bulb . . . . . T5 1/2  
 Base . . . . . 7-pin

**ELECTRICAL DATA**

**RATINGS (Absolute Values)**

Total Anode Current . . . . . 0.60 Ma max.  
 Voltage Between Electrodes  
 (other than anode) . . . . . 140 Volts max.  
 Supply Voltage (anode to cathode) . . . . . 320 Volts min.  
 Input Frequency . . . . . 5,000 P.P.S. max.

**TYPICAL OPERATION**

DC Supply Voltage . . . . . 450 Volts  
 Anode Resistor . . . . . 0.82 Megohms  
 Nominal Tube Drop  
 (under these conditions) . . . . . 195 Volts  
 Cathode Resistor . . . . . 100 Kohms  
 Output Voltage  
 (developed across cathode resistor) . . . . . 30 Volts

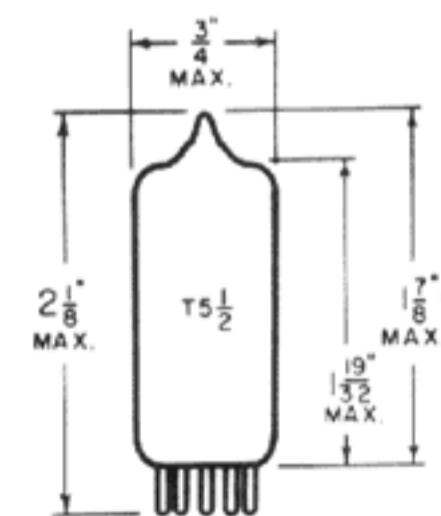

**Outline Drawing**

- Pin No. 1 Cathode No. 8
- Pin No. 2 Guide No. 1
- Pin No. 3 Common Cathode
- Pin No. 4 Guide No. 2
- Pin No. 5 Cathode No. 0
- Pin No. 6 Cathode No. 9
- Pin No. 7 Anode

# 6909-6910

**6909: 100 KC.  
4 OUTPUT CATHODES. T9 BULB**

**6910: 100 KC.  
10 OUTPUT CATHODES. T11 BULB**

## MECHANICAL DATA

Mounting Position . . . . .	Any
	(Count is ready from top of tube)
Zero Position (Cathode No. 10)	
6909 . . . . .	Aligned with pin No. 6 $\pm 10^\circ$
6910 . . . . .	Aligned with pin No. 12 $\pm 10^\circ$
Bulb	
6909 . . . . .	T9
6910 . . . . .	T11
Base	
6909 . . . . .	Octal
6910 . . . . .	Modified Duo-decal*

\*Part No. 7460-0008, available from Sylvania Parts Div., Warren, Pa.

## ELECTRICAL DATA

### RATINGS (Absolute Values)

Total Anode Current . . . . .	1.2 Ma	max.
Voltage Between Electrodes (other than anode) . . . . .	140 Volts	max.
Supply Voltage (anode to cathode) . . . . .	400 Volts	max.
Input Frequency . . . . .	100,000 P.P.S.	max.

## TYPICAL OPERATION

DC Supply Voltage . . . . .	450 Volts
Anode Resistor . . . . .	0.27 Megohms
Nominal Tube Drop (under these conditions) . . . . .	235 Volts
Cathode Resistor . . . . .	24 Kohms
Output Voltage (developed across cathode resistor) . . . . .	15 Volts

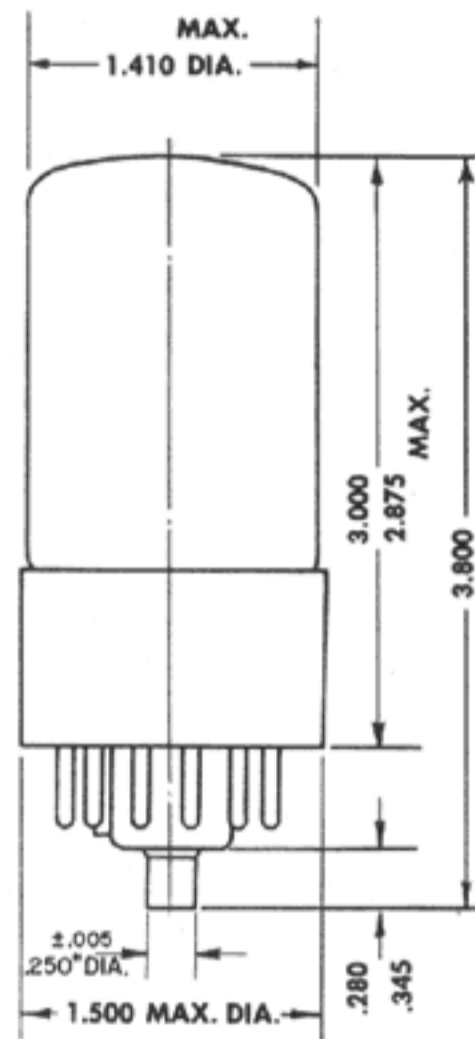

6910 Outline Drawing

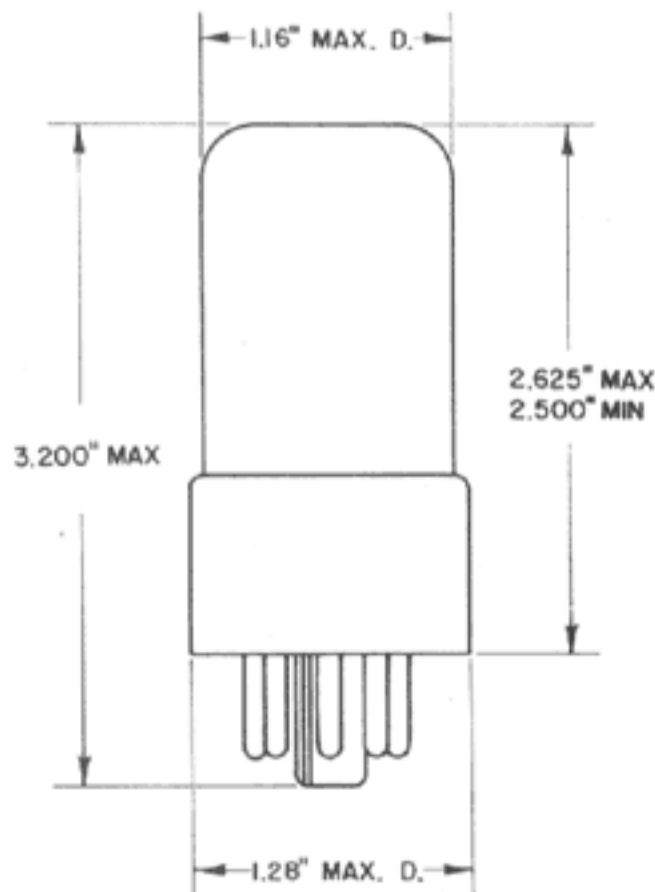

6909 Outline Drawing

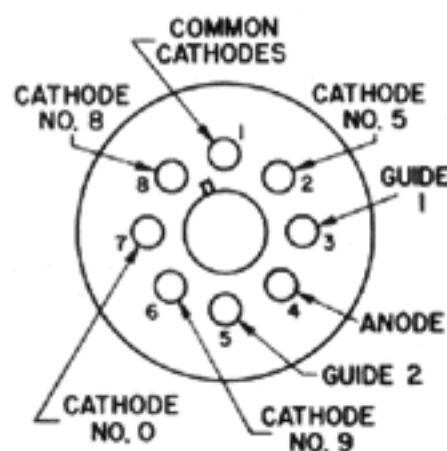

6909 Base Connections

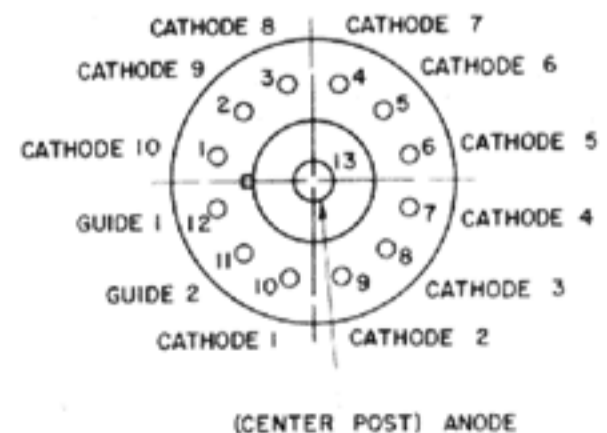

6910 Base Connections