



CR192A

V.H.F. POWER TETRODE

American equivalent 6166A*

Service Type CV8244

The data should be read in conjunction with the Power Tetrode Preamble.

ABRIDGED DATA

Forced-air cooled tetrode with coaxial metal-ceramic envelope, for television and other applications at frequencies up to 220MHz.

Anode dissipation	10	kW max
Anode voltage	6.9	kV max
Frequency for full ratings:		
class C telegraphy or f.m. telephony	60	MHz max
class B or class C television service	216	MHz max
Output power:		
television service (synchronising level)	12	kW
class C telegraphy or f.m. telephony (216MHz)	9.0	kW

GENERAL

Electrical

Filament		thoriated tungsten
Filament voltage (see note 1)	5.0	V
Filament current	175	A
Surge filament current (peak) (see note 2)	400	A max
Filament cold resistance	3.8	m Ω
Peak usable cathode current	20	A
Grid-screen amplification factor ($V_a = 2.0kV$, $V_{g2} = 1.0kV$, $I_a = 2.0A$)	10	
Mutual conductance ($V_a = 2.0kV$, $V_{g2} = 1.0kV$, $I_a = 2.0A$)	25	mA/V

Continued on page 2

* CR192A is a direct replacement for types 6166 and 6166A, except that the filament posts are larger in diameter. Suitable filament adaptors are available to facilitate replacement of 6166 or 6166A in existing equipments (see page 20).

Electrical (continued)

Inter-electrode capacitances:

grid to anode (see note 3)	0.6	pF max
grid to filament	44	pF
anode to filament (see note 3)	0.08	pF max
grid to screen grid	60	pF
screen grid to anode	21	pF

Mechanical

Overall length	11.625 inches (295.3mm) max
Overall diameter	6.410 inches (162.8mm) max
Net weight	17 pounds (7.8kg) approx
Mounting position	vertical, either way up

COOLING

The required quantity of air through the radiator for cooling the anode is indicated on the graphs (pages 17 and 18) and should be delivered by a blower through the radiator before and during the application of any voltages. It should enter at the envelope end and some of the flow should be used to cool the screen-grid seal.

In addition, a flow of about 50ft³/min (1.42m³/min) should be directed at the filament and grid terminals.

The temperature of anode, screen, grid and filament seals must not exceed 180°C.

Power and air supplies may be removed simultaneously.

R.F. POWER AMPLIFIER

(Class B Television Service, U.S.A. System)

(Synchronising-level conditions per valve unless otherwise specified. Voltages are referred to cathode unless otherwise specified)

MAXIMUM RATINGS (Absolute values) (Frequency 54 to 216MHz)

Anode voltage	6.0	kV max
Screen voltage	2.0	kV max
Anode current	4.0	A max
Anode input power	22	kW max
Screen input power	400	W max
Anode dissipation	10	kW max
Grid dissipation	300	W max

TYPICAL OPERATION IN GRID-DRIVE CIRCUIT**(at 216MHz and bandwidth 8.5MHz — see note 4)**

Anode voltage	5.8	kV
Screen voltage	1.2	kV
Grid voltage	-130	V
Peak r.f. grid voltage:		
synchronising level	375	V
pedestal level	290	V
Anode current:		
synchronising level	3.45	A
pedestal level	2.60	A
Screen current (pedestal level)	207	mA
Grid current (approx):		
synchronising level	350	mA
pedestal level	170	mA
Driving power (approx, see note 5):		
synchronising level (see note 6)	800	W
pedestal level	450	W
Output power (approx):		
synchronising level	12	kW
pedestal level	6.8	kW

TYPICAL OPERATION IN CATHODE-DRIVE CIRCUIT**(at 216MHz and bandwidth 8.5MHz — see note 4)**

Anode voltage	5.8	kV
Screen voltage	800	V
Grid voltage	-85	V
Peak r.f. grid voltage:		
synchronising level	330	V
pedestal level	260	V
Anode current:		
synchronising level	3.45	A
pedestal level	2.60	A
Screen current (pedestal level)	152	mA
Grid current (approx):		
synchronising level	405	mA
pedestal level	220	mA
Driving power (approx, see note 7):		
synchronising level (see note 8)	1.3	kW
pedestal level	700	W
Output power (approx):		
synchronising level	12	kW
pedestal level	6.8	kW

GRID-MODULATED R.F. POWER AMPLIFIER

(Class C Television Service, U.S.A. System)

(Synchronising-level conditions per valve unless otherwise specified)

MAXIMUM RATINGS (Absolute Values) (frequency 54 to 216MHz)

Anode voltage	6.0	kV max
Screen voltage	2.0	kV max
Grid voltage (white level)	-1.0	kV max
Anode current	4.0	A max
Anode input power	22	kW max
Screen input power	400	W max
Anode dissipation	10	kW max
Grid dissipation	300	W max

TYPICAL OPERATION IN GRID-DRIVE CIRCUIT

(at 216MHz and bandwidth 8.5MHz, See Note 4)

Anode voltage	5.8	kV
Screen voltage	1.2	kV
Grid voltage:		
synchronising level	-130	V
pedestal level	-195	V
white level	-350	V
Peak r.f. grid voltage	375	V
Anode current:		
synchronising level	3.45	A
pedestal level	2.42	A
Screen current (pedestal level)	148	mA
Grid current (approx):		
synchronising level	350	mA
pedestal level	190	mA
Driving power (approx, see note 5):		
synchronising level (see note 6)	800	W
pedestal level	425	W
Output power (approx):		
synchronising level	12	kW
pedestal level	6.8	kW

ANODE-MODULATED R.F. POWER AMPLIFIER

(Class C Telephony, carrier conditions per valve for use with a maximum modulation factor of 1.0)

MAXIMUM RATINGS (Absolute Values. See Note 9)

Anode voltage	5.0	kV max
Screen voltage	2.0	kV max
Grid voltage	-1.0	kV max
Anode current	2.0	A max
Grid current	600	mA max
Anode input power	10	kW max
Screen input power	270	W max
Anode dissipation	6.6	kW max

TYPICAL OPERATION IN GRID-DRIVE CIRCUIT

(at frequencies up to 60MHz)

Anode voltage	4.7	kV
Screen voltage (modulated 100%, see note 10)	800	V
Grid voltage (see note 11)	-280	V
Peak r.f. grid voltage	485	V
Anode current	1.56	A
Screen current	217	mA
Grid current (approx)	300	mA
Driving power (approx. See note 12)	180	W
Output power (approx)	5.5	kW

R.F. POWER AMPLIFIER AND OSCILLATOR

(Class C Telegraphy, key-down conditions per valve, see Note 19)

AND R.F. POWER AMPLIFIER (Class C, F.M. Telephony)

MAXIMUM RATINGS (Absolute Values. See Note 9)

Anode voltage	6.9	kV max
Screen voltage	2.0	kV max
Grid voltage	-1.0	kV max
Anode current	2.75	A max
Grid current	600	mA max
Anode input power	18	kW max
Screen input power	400	W max
Anode dissipation	10	kW max

TYPICAL OPERATION IN GRID-DRIVE CIRCUIT

Frequency	up to 60	216	216	MHz
Anode voltage	6.4	5.8	5.8	kV
Screen voltage (see note 13)	1.2	1.2	1.2	kV
Grid voltage (see note 14)	-310	-130	-175	V
Peak r.f. grid voltage	560	230	370	V
Anode current	2.75	1.8	2.6	A
Screen current	300	100	267	mA
Grid current (approx)	280	100	222	mA
Driving power (approx) (see note 5)	75	*300	†750	W
Output power (approx)	11.6	6.0	9.0	kW

* See note 15

† See note 16

MAXIMUM PERMISSIBLE ANODE VOLTAGES AND INPUTS (expressed as a percentage of maximum values quoted)

	Frequency	
	60MHz	220MHz
Class C telephony, anode modulated	100%	90%
Class C telegraphy and f.m. telephony		
Class B television service	Full ratings	
Class C television service	54 to 216MHz	

NOTES

1. The valve must be operated at the stated filament voltage. Fluctuations must not exceed $\pm 5\%$.
2. The filament current must not exceed 400A, even momentarily, at any time.
3. Measured with external flat metal shield 12 inches (305mm) square having a centre hole 4.312 inches (109.5mm) diameter located in the plane of the screen grid terminal, perpendicular to the valve axis, and connected to the screen grid.
4. Computed between half-power points and based on valve output capacitance only.
5. The driver stage is required to supply valve losses and r.f. circuit losses. The driver stage should be designed to provide an excess of power

above the indicated value to take care of variations in line voltage, components, initial valve characteristics, and valve characteristics during life.

6. This value includes 700W of r.f. circuit loss at 216MHz.
7. The driver stage is required to supply the r.f. power added to the anode circuit in addition to the losses indicated under Note 5.
8. This value includes 300W of r.f. circuit loss at 216MHz and 900W added to anode circuit.
9. These ratings apply for operation up to 60MHz; for ratings at higher frequencies, see table on page 6.
10. Obtained preferably from a separate source.
11. Obtained preferably from a combination of 365 ohms control grid resistor and -170V fixed bias.
12. This value includes 50W of r.f. circuit loss at 30MHz.
13. Obtained preferably from a separate source, or from the anode supply voltage with a voltage divider, or through a series resistor. A series screen resistor should not be used if the tube or a preceding stage is keyed. In this case, the regulation of the source should be sufficient to prevent the screen voltage from rising above 2000V under key-up conditions and additional fixed grid bias must be provided to limit the anode current.
14. Obtained from fixed supply, by grid resistor, by cathode resistor, or by combination methods.
15. This value includes 270W of r.f. circuit loss.
16. This value includes 675W of r.f. circuit loss.
17. In Class B and Class C television circuits, the valve should be supplied with its grid bias voltage from a source of good regulation — not from a grid resistor. In anode-modulated Class C operation, the grid bias may be obtained from a grid resistor or part from a grid resistor and the balance from either a cathode bias resistor or a fixed voltage. In Class C telegraphy or Class C f.m. telephony operation, the bias may be obtained by any convenient method.
18. With Class B and Class C television circuits, or with Class C f.m. operation the screen should be supplied from a source having good regulation. With anode-modulated Class C operation the screen voltage may preferably be obtained from a separate source and the screen grid should be modulated so as to keep the ratio of screen to anode voltages constant. With Class C telegraphy any convenient method may be used.
19. Modulation essentially negative may be used if the positive peak of the a.f. envelope does not exceed 115% of the carrier conditions.

TYPICAL ANODE CHARACTERISTICS

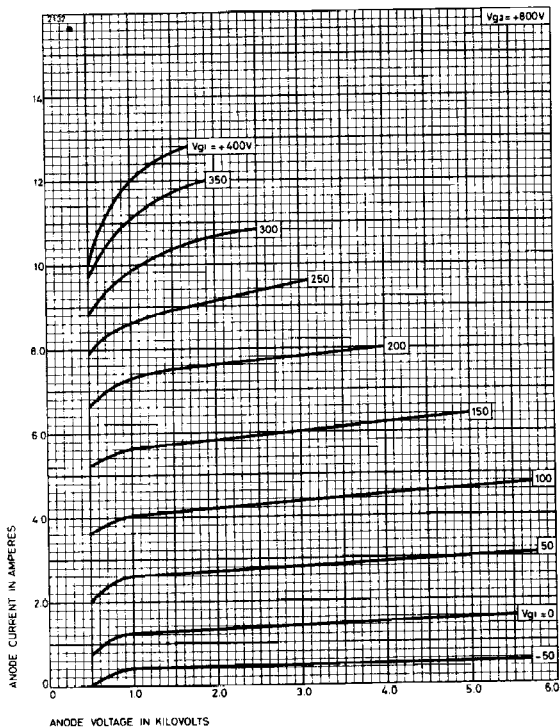

TYPICAL GRID AND SCREEN CHARACTERISTICS

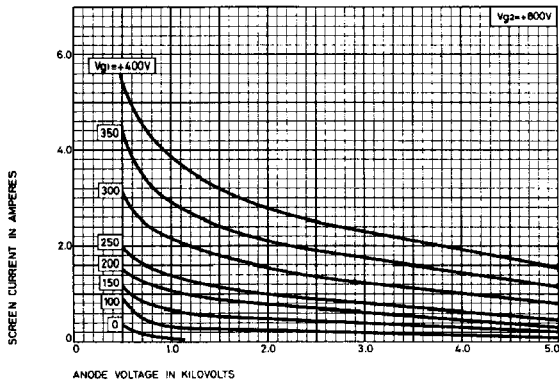
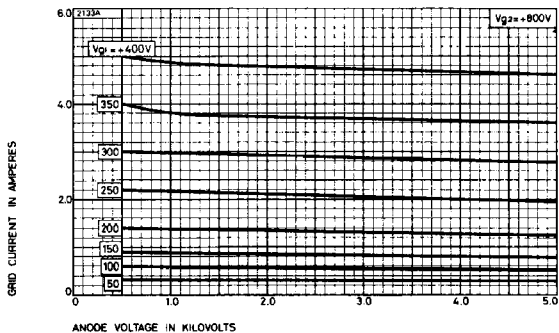

TYPICAL CONSTANT CURRENT CHARACTERISTICS

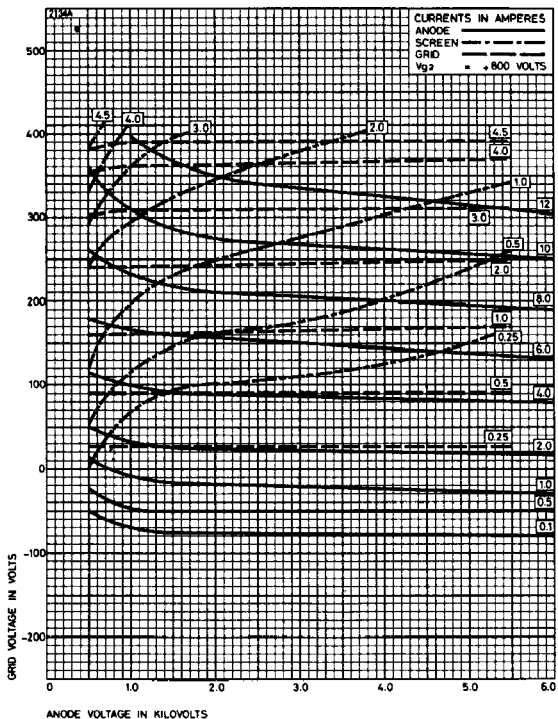

TYPICAL ANODE CHARACTERISTICS

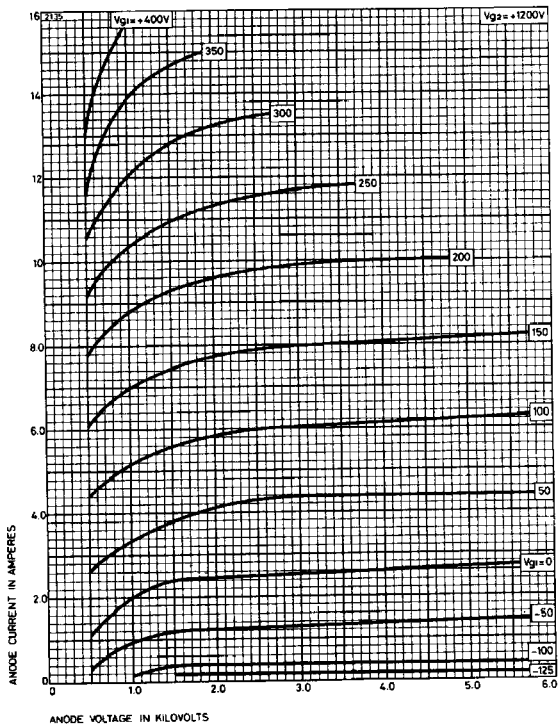

TYPICAL GRID AND SCREEN CHARACTERISTICS

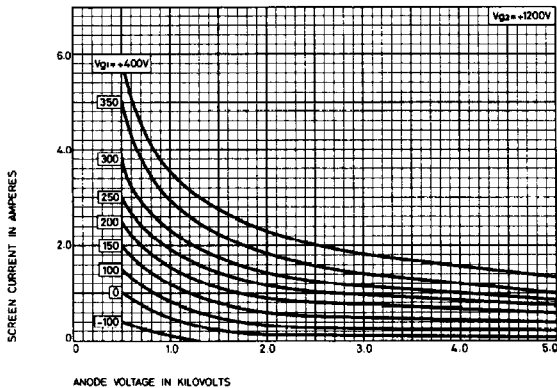
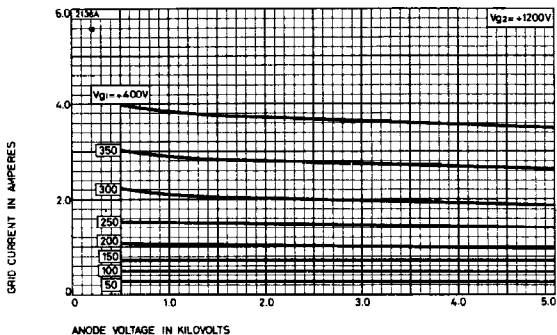

TYPICAL CONSTANT CURRENT CHARACTERISTICS

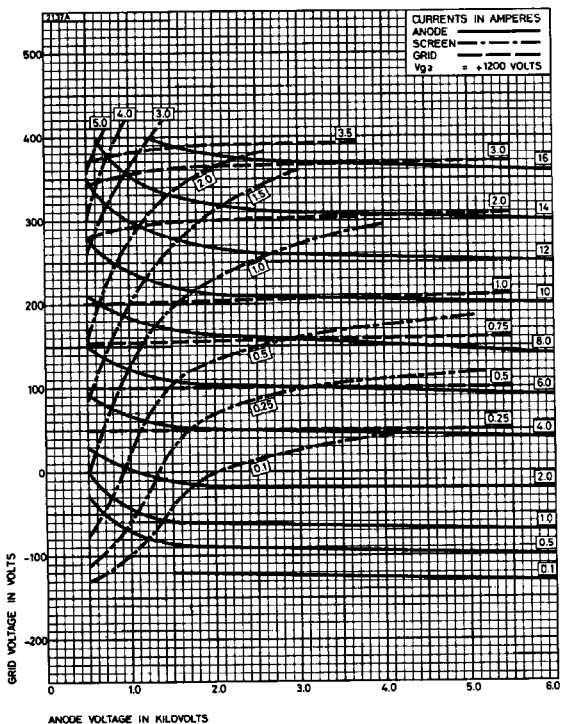

TYPICAL ANODE CHARACTERISTICS

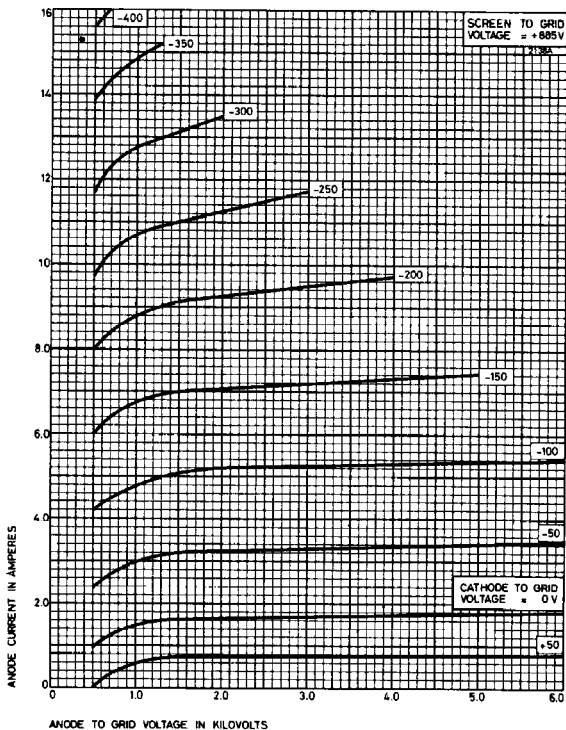

TYPICAL GRID AND SCREEN CHARACTERISTICS

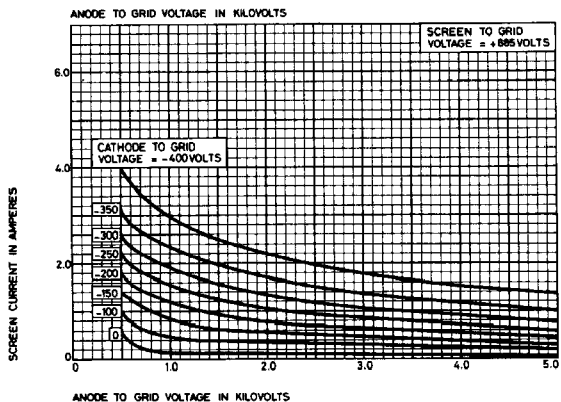
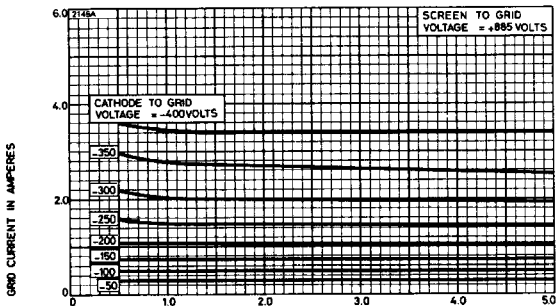

TYPICAL CONSTANT CURRENT CHARACTERISTICS

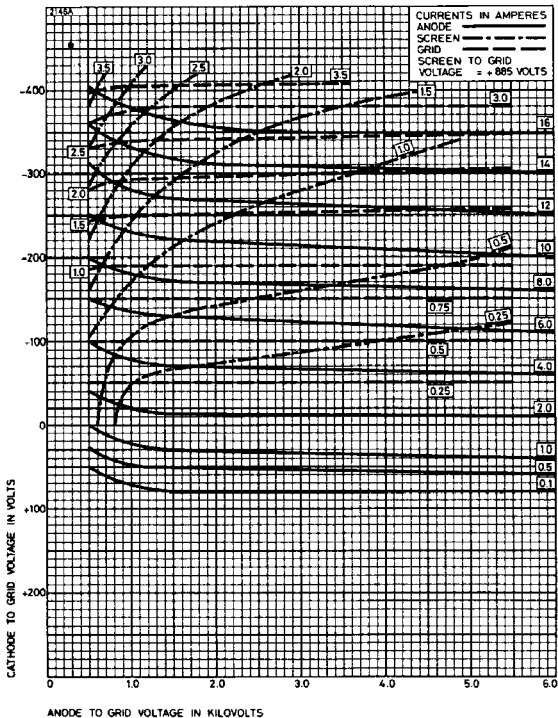

AIR COOLING REQUIREMENTS

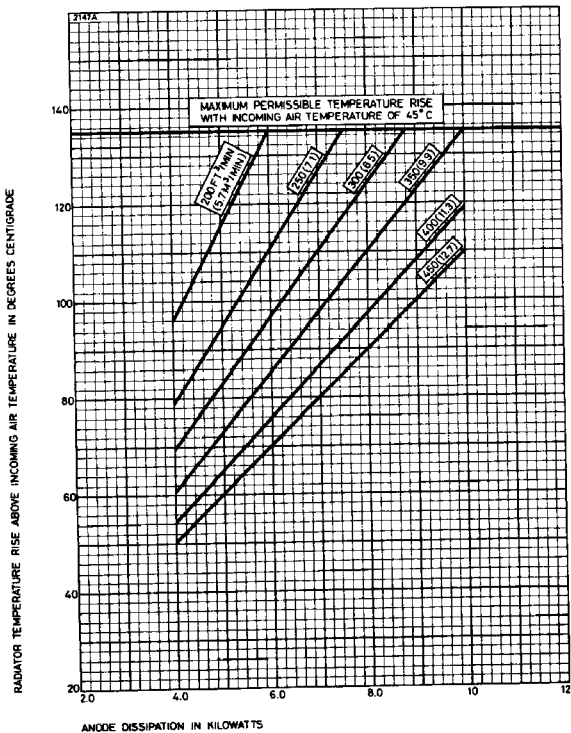

TYPICAL AIR FLOW CHARACTERISTIC

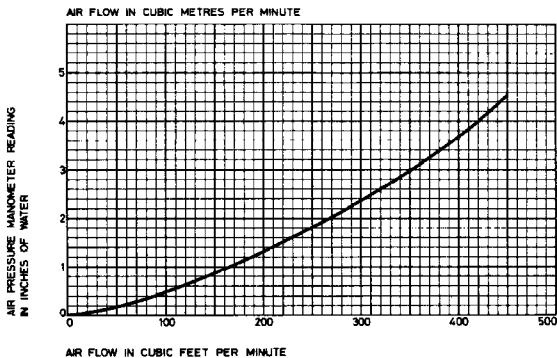
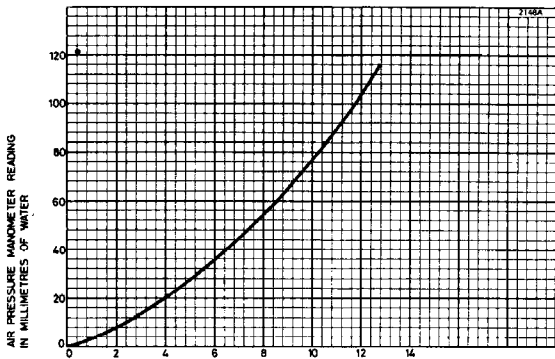

OUTLINE

2149

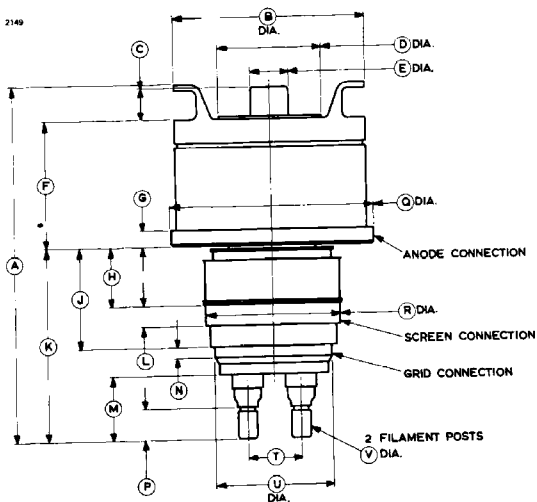

Ref	Inches	Millimetres	Ref	Inches	Millimetres
A	11.625 max	295.3 max	L	0.500 min	12.70 min
B	6.000 ± 0.094	152.4 ± 2.39	M	1.907 min	48.44 min
C	1.150 max	29.21 max	N	0.350 min	8.89 min
D	3.375 max	85.73 max	P	0.812 min	20.62 min
E	1.187	30.15	Q	6.375 ± 0.031	161.9 ± 0.79
F	4.094 max	104.0 max	R	4.248 ± 0.020	107.9 ± 0.51
G	0.500 ± 0.031	12.70 ± 0.79	T	1.710 ± 0.040	43.43 ± 1.02
H	1.846 ± 0.050	46.89 ± 1.27	U	3.685 ± 0.025	93.60 ± 0.64
J	3.151 ± 0.070	80.04 ± 1.79	V	0.625 ± 0.002	15.875 ± 0.051
K	6.094 ± 0.156	154.8 ± 3.96			

Millimetre dimensions have been derived from inches.

PUSH-ON FILAMENT ADAPTORS (Dimensions without limits are nominal)

MA136

MA137

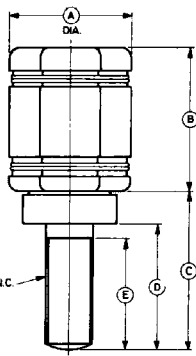
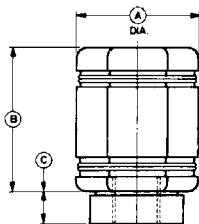
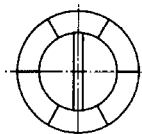
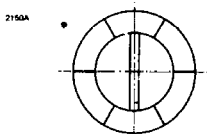

HOLE THREADED
3/8 - 16 U.N.C.
BY (D) DEEP

3/8 - 16 U.N.C.
THREAD

Ref	Inches	Millimetres
A	0.980	24.89
B	1.125	28.58
C	0.250	6.35
D	0.312	7.92

Ref	Inches	Millimetres
A	0.980	24.89
B	1.125	28.58
C	1.250	31.75
D	1.000	25.40
E	0.875 min	22.22 min

Millimetre dimensions have been derived from inches.