

Western Electric

244A Vacuum Tube

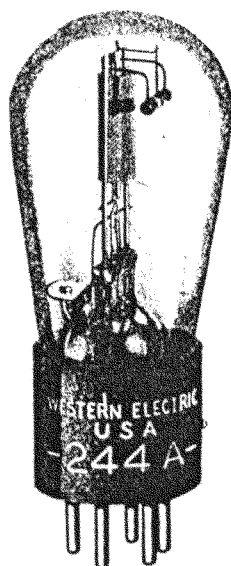

Classification—Low-power triode with indirectly heated cathode

For most applications, the heater element of the 244A tube may be operated on alternating current.

Applications

- Audio-frequency voltage amplifier.
- Audio-frequency power amplifier where small amounts of power are required.
- Oscillator.

Dimensions—Dimensions, outline diagrams of the tube and base, and the arrangement of the electrode connections to the base terminals are shown in Figures 1 and 2.

Base—Medium, five-pin type with bayonet pin.

Socket—Standard, five-contact type, such as the Western Electric 141A socket.

Mounting Positions—The 244A tube may be mounted in any position.

Average Direct Interelectrode Capacitances

	A	B
Grid to plate, $\mu\text{f.}$	3.3	3.2
Grid to heater and cathode, $\mu\text{f.}$	3.1	3.3
Plate to heater and cathode, $\mu\text{f.}$	2.8	3.2

Column A—Based tube without socket.

Column B—Tube alone when measured in 141A socket mounted in metal plate; mounting plate connected to heater and cathode.

Heater Rating

Heater voltage.....	2.0 volts, a.c. or d.c.
Nominal heater current.....	1.6 amperes

The heater element of this tube is designed to operate on a voltage basis and should be operated at as near the rated voltage as is practicable.

Cathode Connection—When the heater is operated on alternating current, a reduction of hum in the tube may usually be obtained by connecting the cathode to a center tap on the secondary of the heater transformer or to the center point of a suitable resistance connected across the heater terminals. If voltage must be applied between the heater and cathode, it should be kept as low as possible and should not exceed 90 volts.

Characteristics—Plate current characteristics of a typical 244A tube are shown in Figure 3 as functions of grid bias for several values of plate voltage. Corresponding amplification factor, plate resistance, and transconductance characteristics are given in Figures 4, 5, and 6, respectively. Plate current characteristics are shown as functions of plate voltage for several values of grid bias in Figure 7.

Operating Conditions and Output—Permissible operating plate and grid voltages are included within the area, ABCD, in Figure 3. Amplification factor, plate resistance, transconductance, and performance data are given in the table on page 3 for a number of typical operating conditions represented by selected points within this area. The less severe operating conditions should be selected in preference to maximum operating conditions wherever possible. The life of the tube at maximum conditions may be shorter than at less severe conditions.

The performance data include the fundamental power output in milliwatts and the second and third harmonic levels in decibels below the fundamental for values of the load resistance, R , equal to one, two, three, or five times the plate resistance, r_p . The peak value of the sinusoidal input, E_{gm} , which gives the indicated power output, P_m , and harmonic levels, F_{2m} and F_{3m} , in each case, is numerically equal to the grid bias. For a smaller input, E_g , the output and harmonic levels, except for very low third harmonic levels, are given approximately by the following relations:

$$P = P_m \left(\frac{E_g}{E_{gm}} \right)^2$$

$$F_2 = F_{2m} + 20 \log_{10} \frac{E_{gm}}{E_g}$$

$$F_3 = F_{3m} + 40 \log_{10} \frac{E_{gm}}{E_g}$$

The level of the third harmonic in the 244A tube is usually low and may differ widely in individual tubes. The values given in the table are for a typical tube.

Microphonic and Sputter Noise—With a plate voltage of 135 volts, a grid bias of -6 volts, and a load resistance of 100,000 ohms, the mean microphonic noise output level of the 244A tube, measured in a laboratory reference test set, is 32 decibels below 1 volt. The range of levels of individual tubes extends from 24 to 43 decibels below 1 volt. Since microphonic noise depends on the type and intensity of the mechanical disturbance which produces it, the values given here are useful chiefly for comparison with the levels of other tubes which have been tested in the same way.

Improvements in the design of the 244A tube have practically eliminated both the disagreeable sputtering sounds and the isolated microphonic noise impulses which sometimes occur spontaneously at random intervals in tubes of this general type. When the tube is shielded from external microphonic noise impulses, it is quiet in operation and can be used for the audio-frequency amplification of exceptionally low level signals.

Plate Voltage Volts	Grid Bias Volts	Plate Current Milli-amperes	Amplification Factor	Plate Resistance Ohms r_p	Trans-conductance Micro-mhos	Input Voltage Peak Volts	Load Resistance R	Power Output Milli-watts	Second Harmonic db	Thrd Harmonic db
90	- 6	1.9	9.5	15100	630	6	$R = r_p$	32	21	50
							$R = 2r_p$	29	25	45
90	- 4	3.3	10.1	11800	850	4	$R = r_p$	20	25	55
							$R = 2r_p$	17	28	50
120	- 8	2.6	9.5	13600	700	8	$R = r_p$	58	21	50
							$R = 2r_p$	51	25	50
							$R = 3r_p$	46	27	50
120	- 6	4.1	9.9	11200	890	6	$R = r_p$	43	24	50
							$R = 2r_p$	39	27	50
120	- 4	6.1	10.4	9500	1090	4	$R = r_p$	24	27	65
							$R = 2r_p$	22	30	60
135	-10	2.4	9.3	14600	640	10	$R = r_p$	84	19	35
							$R = 2r_p$	75	23	45
							$R = 3r_p$	63	26	50
135	- 8	3.8	9.7	11800	820	8	$R = r_p$	69	22	45
							$R = 2r_p$	60	26	50
135	- 6	5.5	10.1	10000	1010	6	$R = r_p$	49	25	50
							$R = 2r_p$	43	28	50
150	-12	2.1	9.1	15800	580	12	$R = 2r_p$	98	22	40
							$R = 3r_p$	86	25	45
150	-10	3.4	9.5	12500	760	10	$R = r_p$	100	21	50
							$R = 2r_p$	89	25	45
							$R = 3r_p$	76	27	45
150	- 8	5.1	9.8	10600	930	8	$R = r_p$	80	23	50
							$R = 2r_p$	70	27	50
*135	- 4	7.7	10.5	8800	1200	4	$R = r_p$	26	28	65
							$R = 2r_p$	24	31	70
*150	- 6	7.1	10.2	9200	1110	6	$R = r_p$	54	26	50
							$R = 2r_p$	47	29	50
*180	-16	1.8	8.9	17800	500	16	$R = 3r_p$	128	23	45
							$R = 5r_p$	104	27	50
*180	-14	2.9	9.2	14000	660	14	$R = 2r_p$	150	22	45
							$R = 3r_p$	130	25	50
*180	-12	4.4	9.5	11600	820	12	$R = r_p$	153	20	45
							$R = 2r_p$	136	24	50
*180	-10	6.2	9.8	10000	980	10	$R = r_p$	128	23	50
							$R = 2r_p$	112	26	45

*Maximum operating conditions.

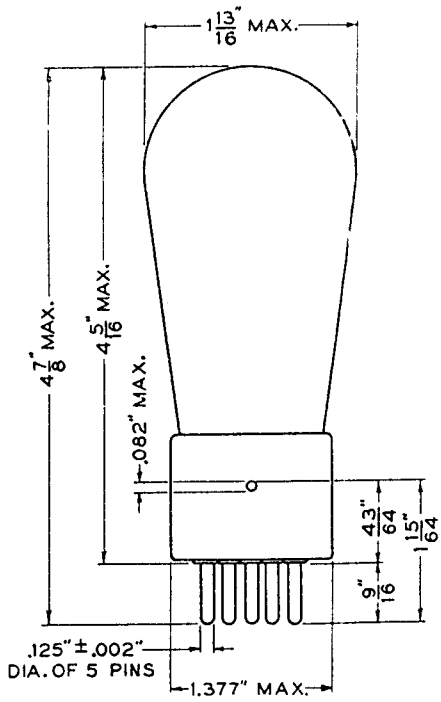

FIG. 1

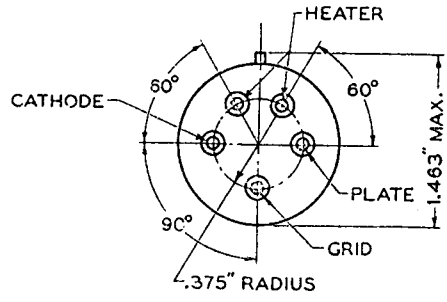

FIG. 2

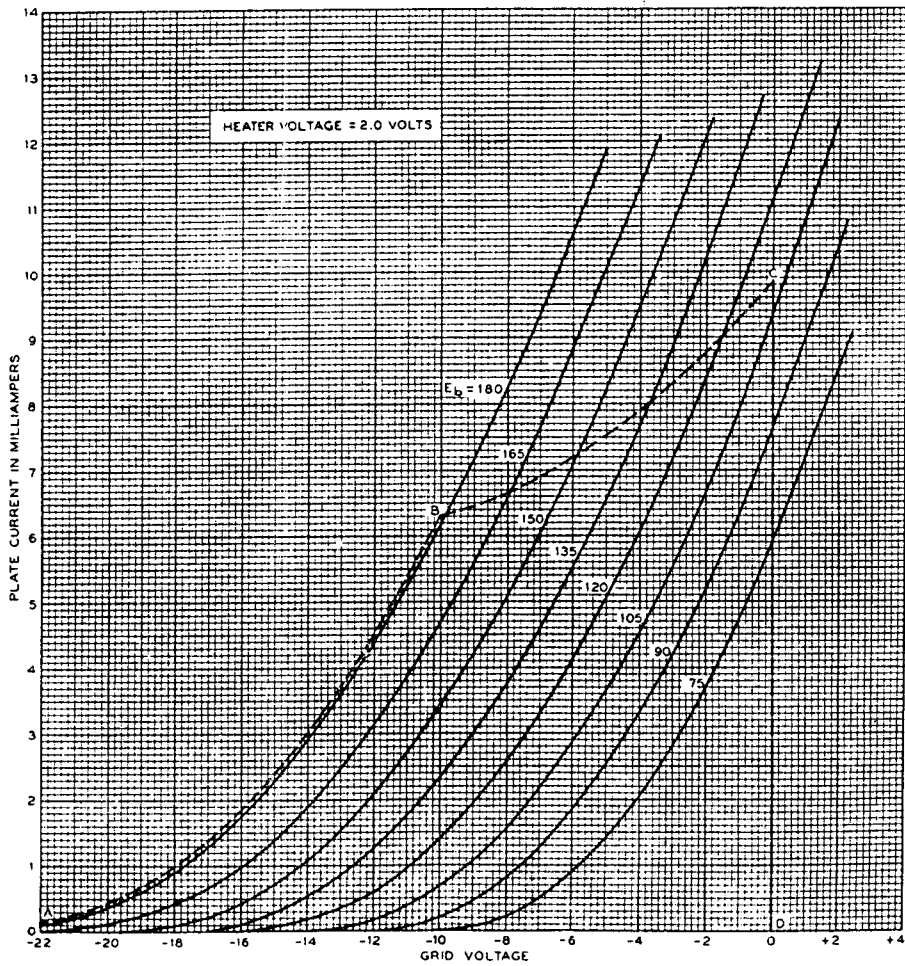

FIG. 3

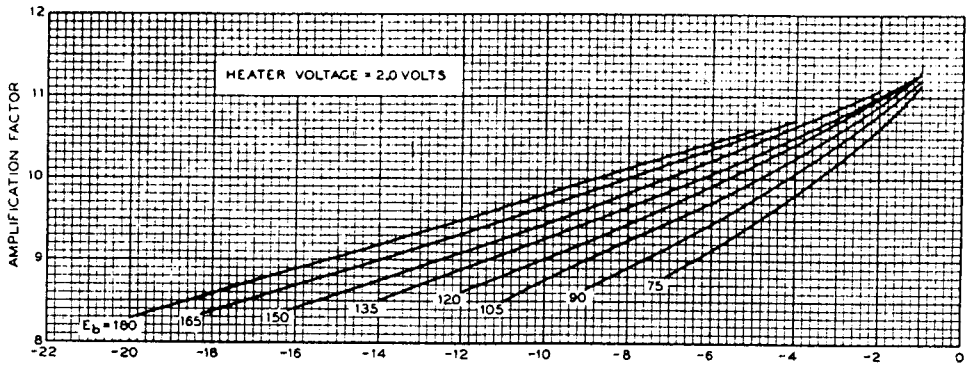

FIG. 4

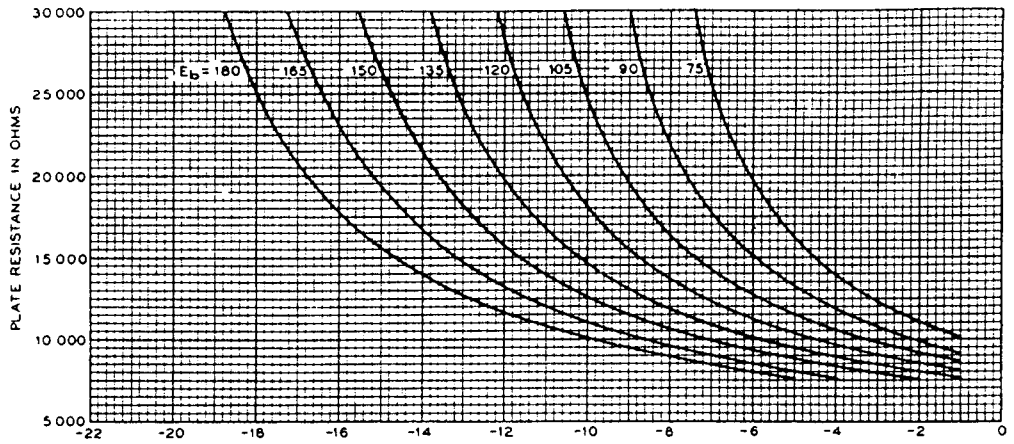

FIG. 5

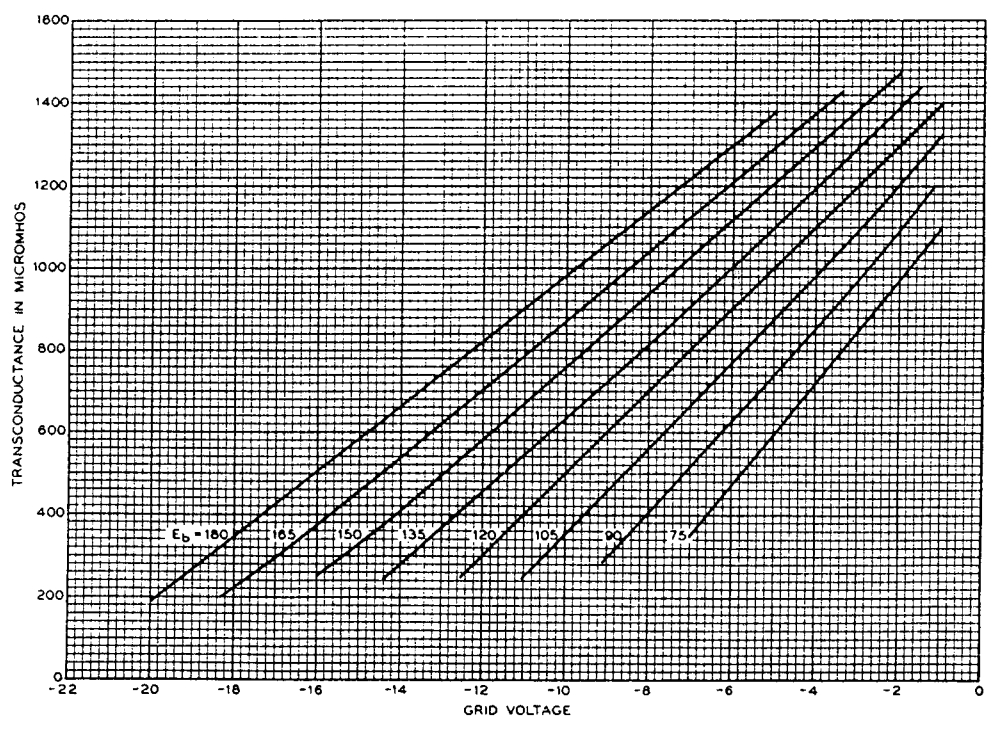

FIG. 6

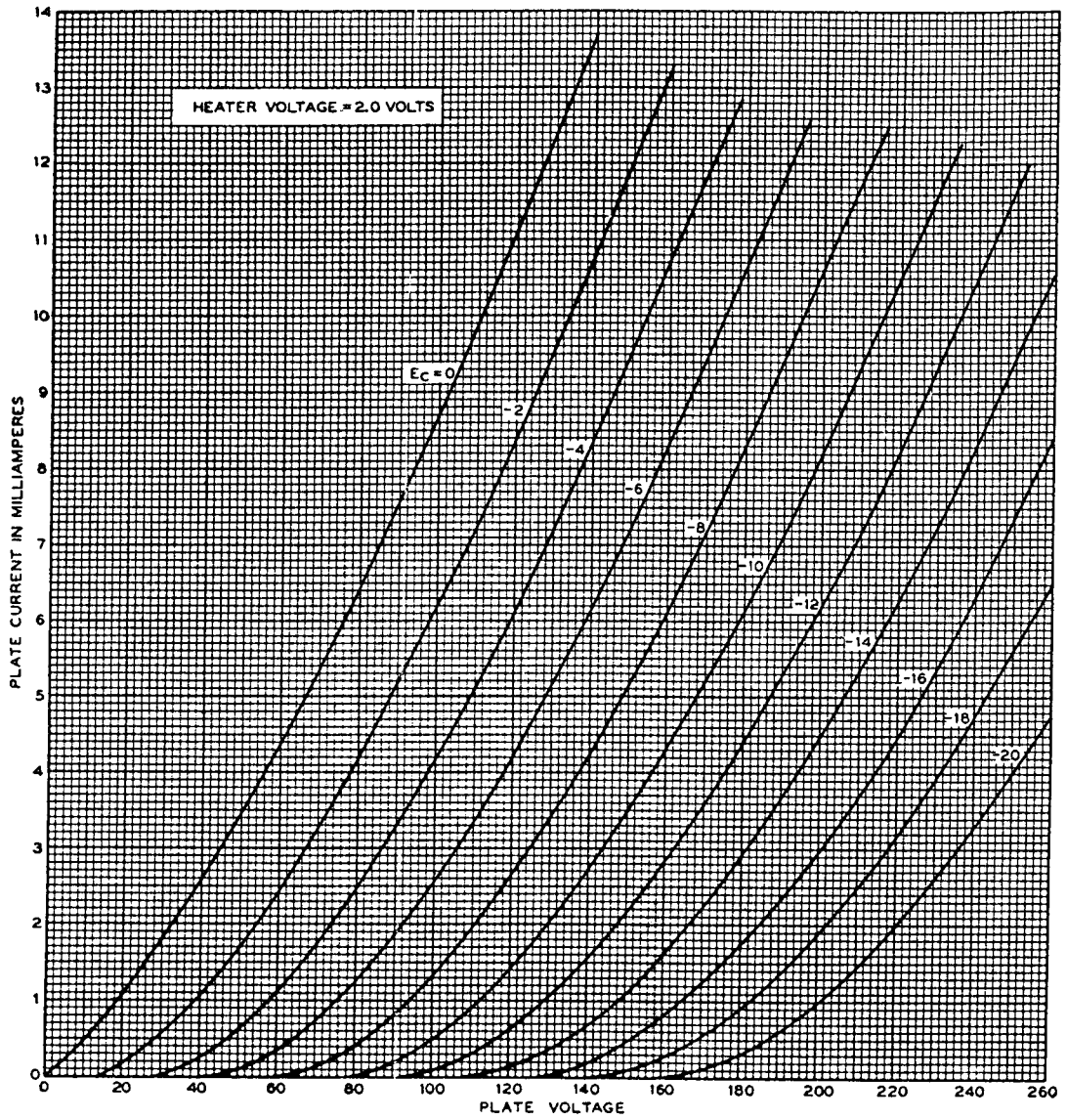

FIG. 7