

MECHANICAL DATA

Bulb	T-3
Base	E8-10, Subminiature Button Flexible Leads
Outline	JETEC 3-1
Basing	8DG
Cathode	Coated Unipotential
Mounting Position	Any

RATINGS¹ (Absolute Maximum)

Impact Acceleration	450 G
Uniform Acceleration	1000 G
Fatigue (Vibrational Acceleration for Extended Periods)	2.5 G
Bulb Temperature	220° C
Altitude ²	80000 Ft.

ELECTRICAL DATA

HEATER CHARACTERISTICS

	Min.	Bogey	Max.
Heater Voltage ³	6.0	6.3	6.6 V
Heater Current		300	mA

DIRECT INTERELECTRODE CAPACITANCES

	Shielded ⁴	Unshielded
Grid to Plate (Each Section)	1.4	1.5 μmf
Input (Each Section)	2.1	2.4 μmf
Output		
Section No. 1	1.3	0.28 μmf
Section No. 2	1.4	0.32 μmf
Grid to Grid	0.011	0.013 μmf Max.
Plate to Plate	0.33	0.52 μmf Max.

RATINGS¹ & ⁵ (Absolute Maximum)

Plate Voltage	165 Vdc
Peak Plate Forward Voltage ⁶	330 v
Plate Dissipation (Each Section)	1.1 W
Plate Current (Each Section)	22 mA Dc
DC Grid Voltage	
Positive Value	0 Vdc
Negative Value	55 Vdc
Grid Current	5.5 mA Dc
Heater-Cathode Voltage	
Heater Positive with Respect to Cathode	200 v
Heater Negative with Respect to Cathode	200 v
Grid Circuit Resistance	1.1 Meg

CHARACTERISTICS (Each Section)

Plate Voltage	100 Vdc
Cathode Resistor	150 Ohms
Plate Current	6.5 mA Dc
Transconductance	5400 μmhos
Amplification Factor	35
Grid Voltage for $I_b = 100 \mu\text{A Dc}$ Max.	-6.5 Vdc

NOTES:

1. Limitations beyond which normal tube performance and tube life may be impaired.
2. If altitude rating is exceeded, reduction of instantaneous voltages (Ef excluded) may be required.
3. Tube life and reliability of performance are directly related to the degree of regulation of the heater voltage to its center rated value of 6.3 volts.
4. External shield of 0.405 inch diameter connected to cathode.
5. Values shown are as registered with RETMA.
6. Per MIL-E-1C Par. 6.5 and General Section of this Sylvania Subminiature Tube Manual titled Specifications and Ratings.

QUICK REFERENCE DATA

The Premium Subminiature Type 6021 is a general purpose, medium μ , double triode having separate cathode connections for each section. It is particularly useful in oscillator and amplifier applications where power requirements permit the use of two tubes in one envelope.

The 6021 is designed to provide dependable operation under conditions of severe shock, vibration, high temperature and high altitude and is manufactured and inspected to meet the applicable MIL-E-1 specification for reliability.

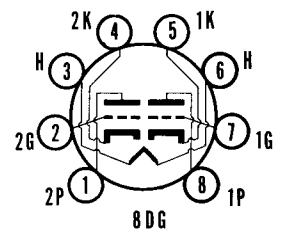
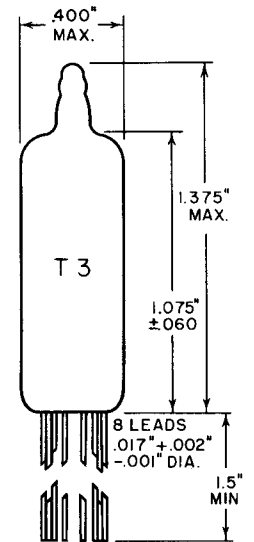

SYLVANIA ELECTRIC PRODUCTS INC.

**RADIO TUBE DIVISION
EMPORIUM, PA.**

*Prepared and Released By The
TECHNICAL PUBLICATIONS SECTION
EMPORIUM, PENNSYLVANIA*

FEBRUARY 1957

PAGE 1 OF 9

ACCEPTANCE CRITERIA

Test Conditions

Heater Voltage 6.3 V
 Plate Voltage 100 Vdc
 Grid Voltage 0 V

Heater-Cathode Voltage MIL-E-1 Par. 3.2.2.1 0 V
 Cathode Resistance Per Cathode MIL-E-1
 Par. 3.2.2.1 150 Ohms

For the purposes of inspection, use applicable reliable paragraphs of MIL-E-1 and Inspection Instructions for Electron Tubes.

MIL-E-1 Ref.	Test	AQL (%)	Limits					Units
			Min.	LAL	Bogey	UAL	Max.	
Measurements Acceptance Tests, Part 1, Note 1								
4.1.1.7 4.10.8	(Method A) Heater Current: ALD = 24	—	—	288	300	312	—	mA
4.10.8	Heater Current:	0.65	280	—	—	—	320	mA
4.10.15	Heater-Cathode Leakage: Note 4	0.65	—	—	—	—	—	—
	Ehk = +100 Vdc	—	—	—	—	—	5.0	μA _{dc}
	Ehk = -100 Vdc	—	—	—	—	—	5.0	μA _{dc}
4.10.6.1	Grid Current: Note 4 Eb = 150 Vdc; Rk = 300 Ohms; Rg = 1.0 Meg	0.65	0	—	—	—	-0.3	μA _{dc}
4.1.1.7 4.10.4.1	(Method A) Plate Current (1): Note 4 ALD = 2.3	—	—	5.6	6.5	7.3	—	mA _{dc}
4.10.4.1	Plate Current (1):	0.65	4.5	—	—	—	8.5	mA _{dc}
4.10.4.1	Plate Current (2): Note 4 Ec = -6.5 Vdc; Rk = 0 Ohms	0.65	—	—	—	—	100	μA _{dc}
4.1.1.7 4.10.9	Transconductance (1): Note 4 ALD = 1100 Sm	—	—	5000	5400	5800	—	μmhos
4.10.9	Transconductance (1): Sm	0.65	4450	—	—	—	6350	μmhos
4.7.5	Continuity and Shorts: (Inoperatives)	0.4	—	—	—	—	—	—
4.9.1	Mechanical: Envelope (8-1)	—	—	—	—	—	—	—
Measurements Acceptance Tests, Part 2								
4.8.2	Insulation of Electrodes: Note 4	2.5	—	—	—	—	—	—
	g-all	—	100	—	—	—	—	Meg
	p-all	—	100	—	—	—	—	Meg
4.10.4.1	Plate Current (1) Difference Between Sections:	2.5	—	—	—	—	1.6	mA _{dc}
4.10.9	Transconductance (2): Note 4 $\Delta \frac{Sm}{Ef}$ Ef = 5.7 V	2.5	—	—	—	—	15	%
4.10.6.2	Grid Emission: Notes 4 and 5 Ef = 7.5 V; Ec = -7.5 Vdc; Eb = 150 Vdc; Rk = 0 Ohms; Rg = 1.0 Meg	2.5	0	—	—	—	-0.5	μA _{dc}
4.10.3.2	AF Noise: Note 7 Esig = 65 mVac; Rg = 0.1 Meg; Rp = 0.01 Meg; Rk = 75 Ohms; Ck = 1000 μf	2.5	—	—	—	—	17	UV
— — — —	Pulse Emission: Notes 4 and 6 Ef = 6.0 V; e pulse = 50 v; tp = 25 μsec; prr = 200 pps	6.5	300	—	—	—	—	ma
4.10.11.1	Amplification Factor: Note 4	6.5	30	—	35	—	40	—
4.10.14	Capacitance:	6.5	—	—	—	—	—	—
	No Shield; Note 4 Cgp	—	1.2	—	—	—	1.8	μμf
	No Shield; Note 4 Cin	—	1.8	—	—	—	3.0	μμf
	No Shield; Section 1 Cout	—	0.20	—	—	—	0.36	μμf
	No Shield; Section 2 Cout	—	0.22	—	—	—	0.42	μμf
	No Shield Cgg	—	—	—	—	—	0.013	μμf
	No Shield Cpp	—	—	—	—	—	0.52	μμf

ACCEPTANCE CRITERIA (Continued)

MIL-E-I Ref.	Test	AQL (%)	Limits					Units
			Min.	LAL	Bogey	UAL	Max.	
Measurements Acceptance Tests, Part 2 (Continued)								
4.9.12.1	Low Pressure Voltage Breakdown: Pressure = 20 ± 5 mm Hg.; Voltage = 300 Vac.....	6.5	—	—	—	—	—	
4.9.20.3	Vibration (1): No Voltages; Post Shock and Fatigue Test End Points Apply	10.0	—	—	—	—	—	
4.9.19.1	Vibration (2): Note 4 Rp = 10,000 Ohms; Ck = 1000 μ f; F = 40 cps; G = 15.....	2.5	—	—	—	—	50	mVac
4.9.19.1	White Noise: (Each Section); Note 8 Rp = 10,000 Ohms; Ck = 1000 μ f;..... Peak Acceleration = 15 G.....	2.5 2.5	— —	— —	— —	— —	250 50	mv pk-pk mVac
Degradation Rate Acceptance Tests, Note 2								
4.9.5.3	Subminiature Lead Fatigue.....	2.5	4	—	—	—	—	arcs
4.9.20.5	Shock: Hammer Angle = 30°; Ehk = +100 Vdc; Rg = 0.1 Meg....	20	—	—	—	—	—	
4.9.20.6	Fatigue: G = 2.5; Fixed Frequency; F = 25 min., 60 max.....	6.5	—	—	—	—	—	
-----	Post Shock and Fatigue Test End Points: Vibration (2).....	—	—	—	—	—	200	mVac
	Heater-Cathode Leakage Ehk = +100 Vdc.....	—	—	—	—	—	20	μ Adc
	Ehk = -100 Vdc.....	—	—	—	—	—	20	μ Adc
	Change in Transconductance (1) of Individual Tubes $\Delta \frac{Sm}{t}$	—	—	—	—	—	20	%
4.9.6.3	Glass Strain.....	6.5	—	—	—	—	—	

MIL-E-I Ref.	Test	AQL (%)	Allowable Defectives per Characteristic		Limits		Units
			1st Sample	Combined Samples	Min.	Max.	
Acceptance Life Tests, Note 2							
4.11.7	Heater Cycling Life Test: Ef = 7.0 V; 1 min. on, 4 min. off; Ehk = 140 Vac; Ec = Eb = 0 V.....	2.5	—	—	—	—	
4.11.3.1	Stability Life Test: (1 Hour) Note 7 Ehk = +200 Vdc; Rg/g = 1.0 Meg; TA = Room.....	1.0	—	—	—	—	
4.11.4	Stability Life Test End Points: Change in Transconductance (1) of Individual Tubes $\Delta \frac{Sm}{t}$	—	—	—	—	15	%
4.11.3.1	Survival Rate Life Test: (100 Hours) Stability Life Test Conditions or Equivalent; TA = Room....	—	—	—	—	—	
4.11.3.1.1		—	—	—	—	—	
4.11.4	Survival Rate Life Test End Points: Continuity and Shorts (Inoperatives).....	0.65	—	—	—	—	
4.11.5	Intermittent Life Test: Note 3 Stability Life Test Conditions; T Envelope = +220°C min.; 1000 Hour Requirements Do Not Apply.....	1.0	—	—	40000	—	μ mhos
4.11.3.1		—	—	—	—	—	

ACCEPTANCE CRITERIA (Continued)

MIL-E-I Ref.	Test	AQL (%)	Allowable Defectives per Characteristic		Limits		Units
			1st Sample	Combined Samples	Min.	Max.	
Acceptance Life Tests, Note 2 (Continued)							
4.11.3.1 4.11.4	Intermittent Life Test End Points: (500 Hours)						
	Inoperatives	—	1	3	—	—	
	Grid Current	—	1	3	0	-0.9	μA _{dc}
	Heater Current	—	2	5	276	328	mA
	Change in Transconductance (1) of Individual Tubes	—	1	3	—	25	%
	Transconductance (2)	—	2	5	—	15	%
	Heater-Cathode Leakage	—	2	5	—	—	
	Ehk = +100 Vdc	—	—	—	—	10	μA _{dc}
	Ehk = -100 Vdc	—	—	—	—	10	μA _{dc}
	Insulation of Electrodes	—	2	5	—	—	
	g-all	—	—	—	50	—	Meg
	p-all	—	—	—	50	—	Meg
	Transconductance (1) Average Change, Avg	—	—	—	—	15	%
	Total Defectives	—	4	8	—	—	

ACCEPTANCE CRITERIA NOTES:

- The AQL for the combined defectives for attributes in Measurements Acceptance Tests, Part 1, excluding inoperatives and mechanical shall be one (1) percent. A tube having one (1) or more defects shall be counted as one (1) defective.
- Tubes subjected to the following destructive tests are not to be accepted under this specification.
 - 4.9.5.3 Subminiature lead fatigue
 - 4.9.20.5 Shock
 - 4.9.20.6 Fatigue
 - 4.11.7 Heater cycling life test
 - 4.11.5 Intermittent life test

- Envelope temperature is defined as the highest temperature indicated when using a thermocouple of #40 BS or smaller diameter elements welded to a ring of 0.025 inch diameter phosphor bronze placed in contact with the envelope. Envelope temperature requirement will be satisfied if a tube, having bogey Ib (±5%) under normal test conditions, is determined to operate at maximum specified temperature at any position on the life rack.
- Test each section separately.
- Prior to this test tubes shall be preheated five (5) minutes with each section operating separately at conditions indicated below. Test within three (3) seconds after preheating. Three-minute test is not permitted. Grid Emission shall be the last test performed on the sample selected for the Grid Emission Test.

Ef	Ec	Eb	Rk	Rg
V	Vdc	Vdc	Ohms	Meg
7.5	0	150	500	1.0

- The pulse is essentially a square wave with 1.0 μsec rise time and 0.8 μsec fall. The pulse shall be applied to plate and grid tied together. Pulse emission shall be measured in terms of voltage developed across a 1.0 ohm resistor in the cathode circuit. Test limit as measured by the leading edge of a calibrated trace, the amplitude of the trailing edge of which shall not vary by more than 20 percent from the value of the leading edge. Test each unit separately.

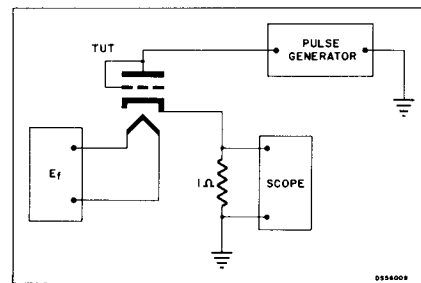

- Tie 1k to 2k; 1g to 2g; and 1p to 2p.
- The tube shall be rigidly mounted on a table vibrating such that the instantaneous values of acceleration shall constitute approximately a "White Noise" spectrum which is free from discontinuities from 100 cps to 5000 cps. The spectrum of instantaneous acceleration shall be such that each octave of bandwidth delivers 2.3 G's rms acceleration. With this the case, the rms value of acceleration for any bandwidth within the specified spectrum is equal to

$$G_{rms} = 2.3 G \sqrt{3.32 \log_{10} (f_2/f_1)}$$

f₂ and f₁ are the upper and lower frequencies respectively of the band under consideration. The degree of clipping of the peak accelerations shall be such that the peak value of acceleration is at least 15 G's.

The voltage (ep) produced across the resistor (Rp) as a result of vibration shall be coupled through a compensating amplifier to a low pass filter. The compensating amplifier shall have a high input impedance (0.25 megohm or more) and shall be adjusted to compensate for any insertion losses in the filter. The combined frequency response of amplifier and filter shall be flat within ±0.5 db from 50 cps to 8000 cps, shall be down no more than 5 db at 10,000 cps and at 20 cps, and down at least 40 db at 13,000 cps. For reading the peak to peak value of output voltage the filter output shall be fed directly to the input of a Ballantine Model 305 peak to peak electronic voltmeter or equal, while the rms value shall be measured with a Hewlett-Packard Model 400C or equal.

APPLICATION DATA

The Sylvania Premium Subminiature Type 6021 is a medium μ double triode having separate cathode connections for each section. It is intended as a general purpose tube and is particularly useful in applications where power requirements are such that the 6021 may be employed rather than two high power single triodes. Among the many uses for this type are a number of low frequency amplifier and oscillator configurations. To insure optimum performance in pulse applications this type is subjected to a pulse emission test as shown in the accompanying data. The tube must, under the specified pulse operating conditions, deliver a minimum specified current. A further discussion of this test is included in the general section of this manual.

Resistance coupled amplifier data is shown in the accompanying table.

The Type 6021 may also be used as uhf amplifier. Instability, however, may be noted with cascode arrangements at frequencies above approximately 100 mc. Input resistance is plotted as a function of frequency in Figure 1.

To insure correlation with actual field conditions and thereby enhance equipment reliability, vibrational noise output is controlled by the "white noise test" as shown in the acceptance criteria. Briefly, this test consists of subjecting the tubes to a white noise vibration spectrum

covering the frequency band of 100 to 5000 cps at a rms level of 2.3 g's per octave and a peak level of 15 g's. Limits are shown for both peak and rms output. A further discussion of the white noise vibrational test is included in the frontal section of this manual.

Life expectancy is described by the life tests, specified on the attached pages and/or individual MIL-E-1 specifications. The actual life expectancy of the tubes in an operating circuit is affected by both the operating and environmental conditions involved. Likewise, the life tests specified indicate performance under certain operating criteria to a set of specified end points. Performance at conditions other than those specified can usually be estimated only roughly as giving better or poorer life expectancy. For further discussion of life expectancy, reference should be made to the frontal section of this manual.

The Type 6021 is manufactured and inspected to meet the applicable MIL-E-1 specification and is intended for operation under severe conditions of vibration, shock, high temperature and high altitude.

When operated under conditions common to on-off control applications the tube exhibits freedom from the development of interface resistance. The heater-cathode construction is designed to withstand intermittent operation.

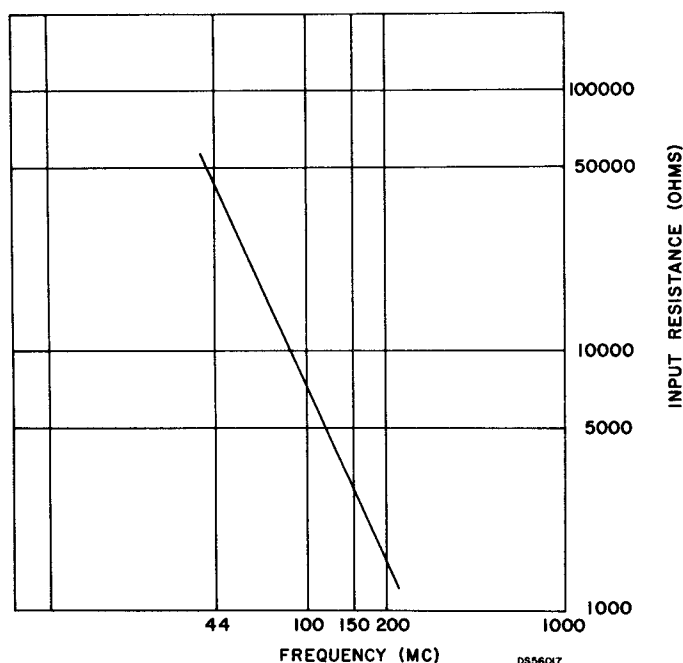

Figure 1—Input resistance vs frequency

The information presented on this data sheet is furnished without assuming any obligation.

RESISTANCE COUPLED AMPLIFIER DATA
SELF-BIAS OPERATION

Rb (megohms).....	Ebb = 100 Volts								Ebb = 200 Volts							
	.047		0.10		0.27		.47		.047		.10		.27		.47	
Rcf (megohms).....	.10	.27	.10	.47	.27	.47	.47	1.0	.10	.27	.10	.47	.27	.47	.47	1.0
Rk (ohms).....	1500	1500	2200	3300	6800	8200	12000	16000	1000	1200	1500	2700	4700	5600	9100	12000
Ib (ma).....	.85	.86	.51	.44	.19	.18	.115	.10	2.05	1.95	1.20	.98	.45	.43	.26	.24
Ec (volts).....	-1.27	-1.29	-1.12	-1.45	-1.29	-1.48	-1.38	-1.60	-2.05	-2.34	-1.80	-2.65	-2.12	-2.40	-2.36	-2.88
Eb (volts).....	58.8	58.2	47.9	54.5	47.4	49.8	44.6	51.4	101.6	106.2	78.2	99.4	76.9	81.6	75.6	84.1
Esig (volts, rms).....	.1	.1	.1	.1	.1	.1	.1	.1	.1	.1	.1	.1	.1	.1	.1	.1
Eout (volts, rms).....	2.01	2.14	2.04	2.18	2.05	2.1	2.04	2.14	2.34	2.42	2.36	2.4	2.3	2.36	2.28	2.29
Gain.....	20.1	21.4	20.4	21.8	20.5	21.0	20.4	21.4	23.4	24.2	23.6	24.0	23.0	23.6	22.8	22.9
% Distortion.....	1.4	1.4	1.4	2.4	1.4	2.3	2.4	1.5	1.20	1.3	1.3	1.4	1.3	1.3	1.3	1.4
Esig* (volts, rms).....	.47	.57	.42	.63	.55	.62	.58	.78	1.15	1.35	.97	1.41	1.15	1.35	1.2	1.6
Eout (volts, rms).....	9.4	12.1	8.5	13.5	11.0	12.8	11.7	16.0	26.8	32.1	22.8	33.5	26.5	31.5	27.2	36.0
Gain.....	20.0	21.2	20.2	21.4	20.0	20.5	20.2	20.5	23.3	23.8	23.5	23.8	23.0	23.3	22.6	22.6
% Distortion.....	5.0	5.0	4.7	5.0	5.0	5.0	5.0	5.0	5.0	5.0	5.0	5.0	5.0	4.9	4.8	5.0

*Maximum signal for 5% distortion or 1/8 microampere grid current.

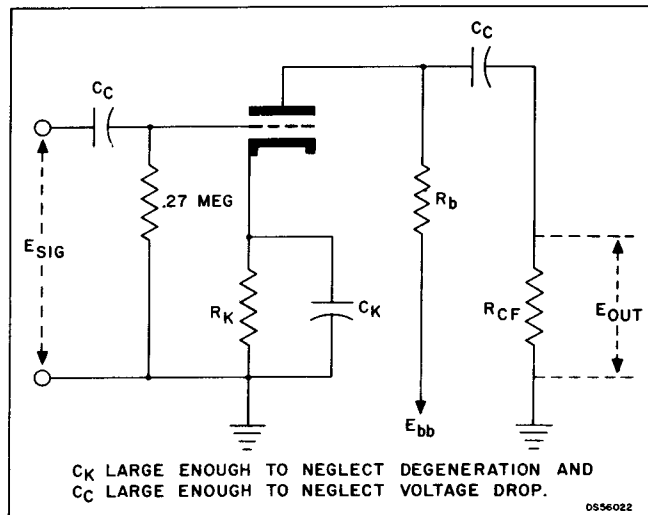

Resistance coupled amplifier circuit (Self-Bias)

AVERAGE PLATE CHARACTERISTICS

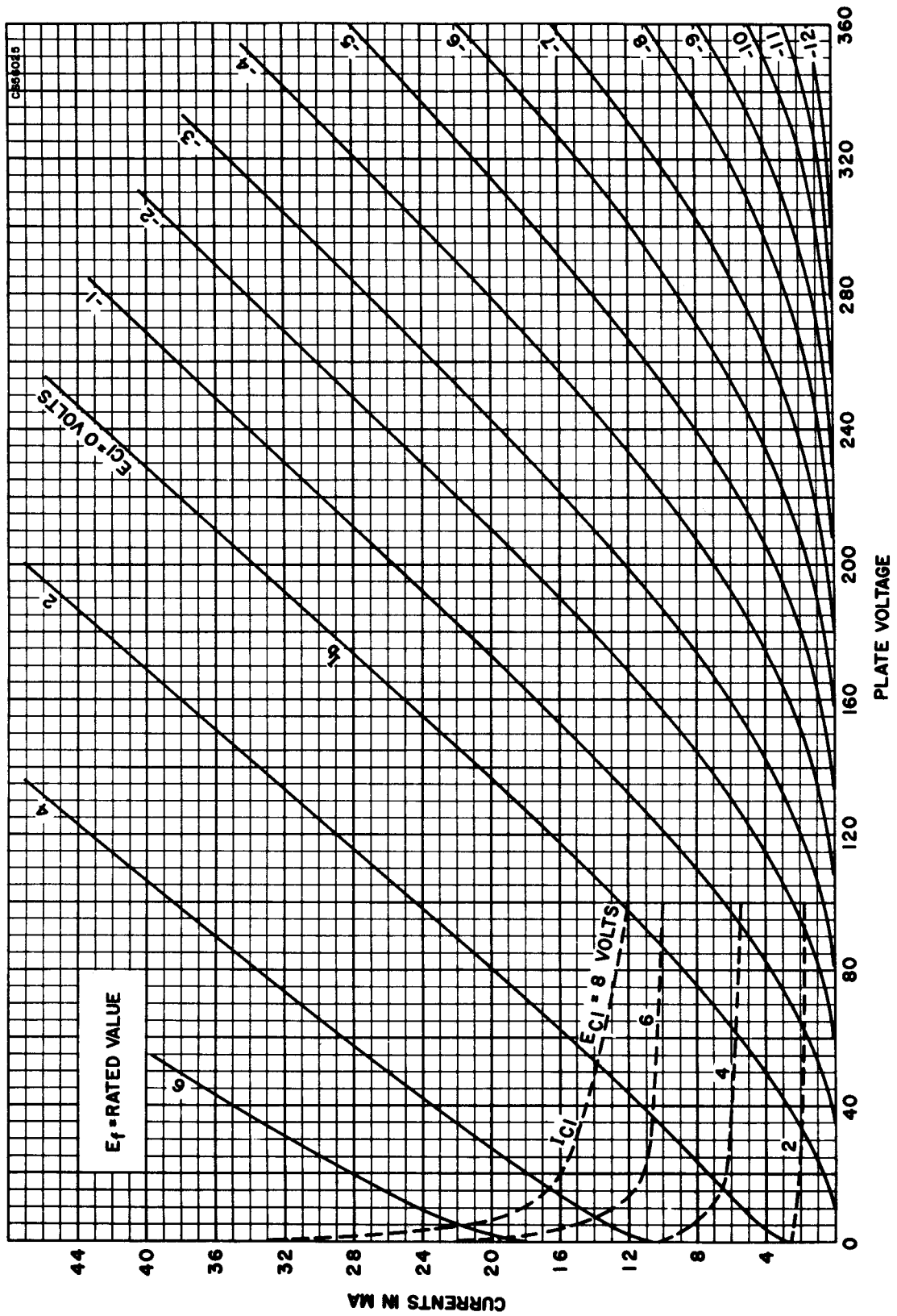

AVERAGE TRANSFER CHARACTERISTICS

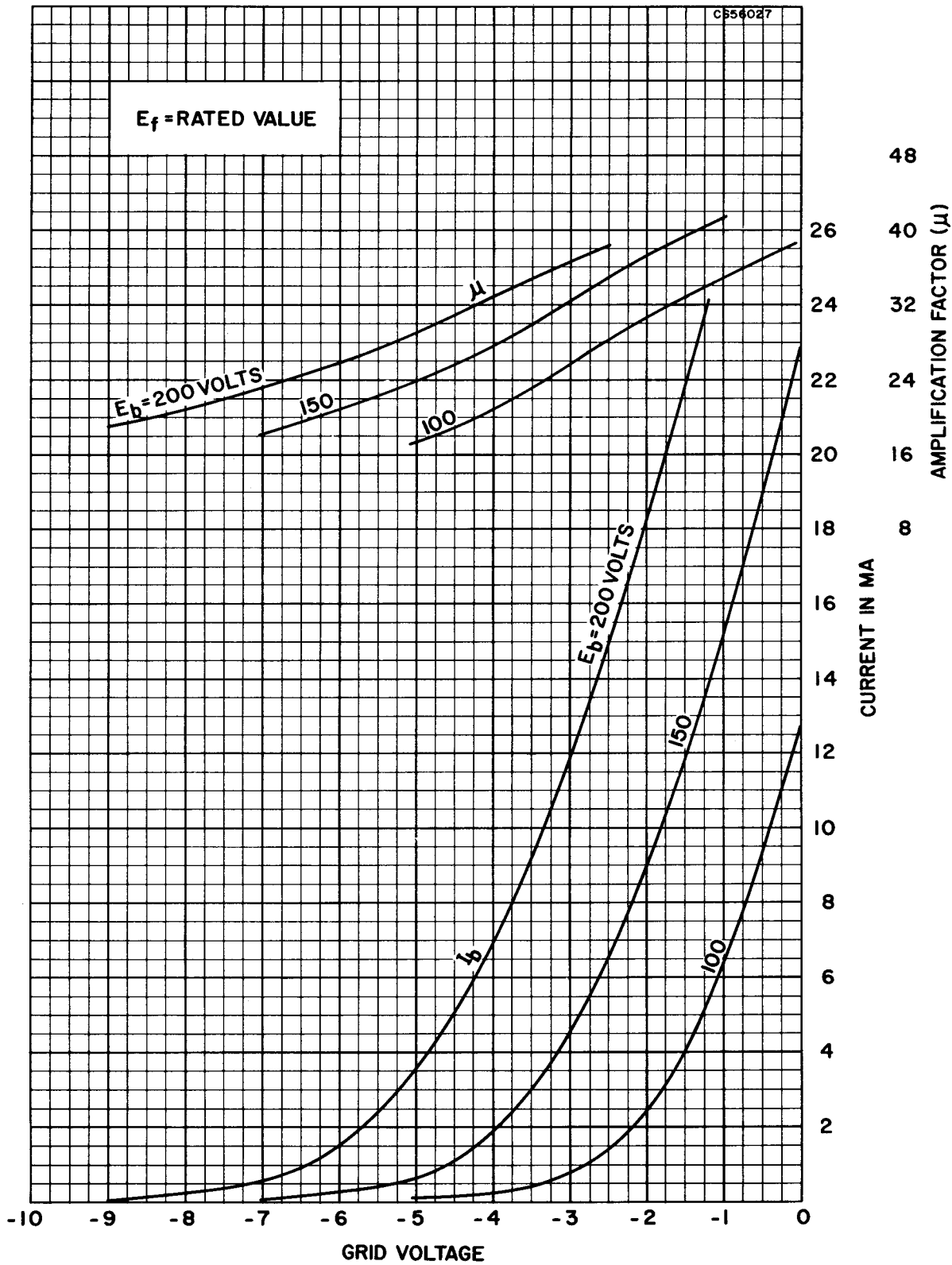

AVERAGE TRANSFER CHARACTERISTICS

