

Recording storage tube | TCM 15X



TCM 15X

BARRIER GRID STORAGE TUBE WITH HIGH RESOLUTION.

The tube TCM 15X is a barrier grid storage tube which can store an amplitude modulated signal as a charge pattern on a dielectric surface for a long period of time. The used phenomenon for creating the charges is the secondary emission of the dielectric target. The tube has a single gun.

PIN ARRANGEMENT

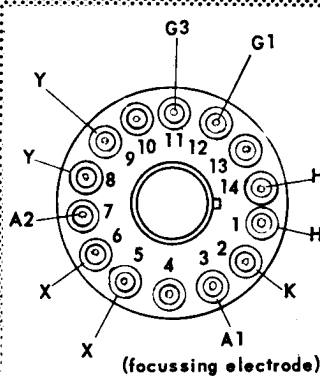

Medium Schell
Diheptal 14 pins
base JETEC
n° B 14-38

OUTSIDE DIMENSIONS

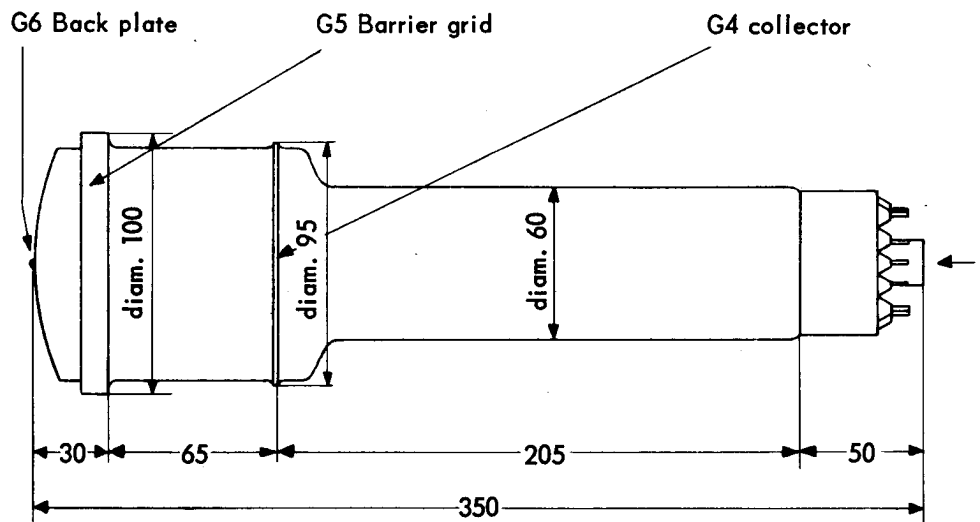

Dimensions in millimeters

Net weight : 2.20 lbs

Compagnie générale

Société Anonyme au Capital de 40.608.900 Nouveaux Francs
Siège Social : 79, Bd HAUSSMANN - PARIS - 8^e - ANJ. 84-60

Février 1960



Printed in France

de télégraphie Sans Fil

DIVISION TUBES ÉLECTRONIQUES
Direction Commerciale : 79, Bd Haussmann, PARIS-8^e - ANJ. 84-60

Doc.CSF.11.035

1/6

STRUCTURE

The tube is made of :

- a high resolution gun with a triode type first lens, an electrostatic focusing lens, an astigmatism correcting iris G3 and electrostatic deflecting plates X and Y. The focusing lens is symmetrical, therefore no current flows into the focus electrode A1. The two sets of deflecting plates X and Y are inside a shield called "plate box" connected to the anode A2.
- an optical device for collecting the secondaries coming from the target. This is accomplished by a conically shaped collector G4.
- a mesh and target assembly consisting of a thin insulating shut on the front face of which a fine mesh is applied and on backface of which is the metallic backplate.

ELECTRICAL CONNECTIONS

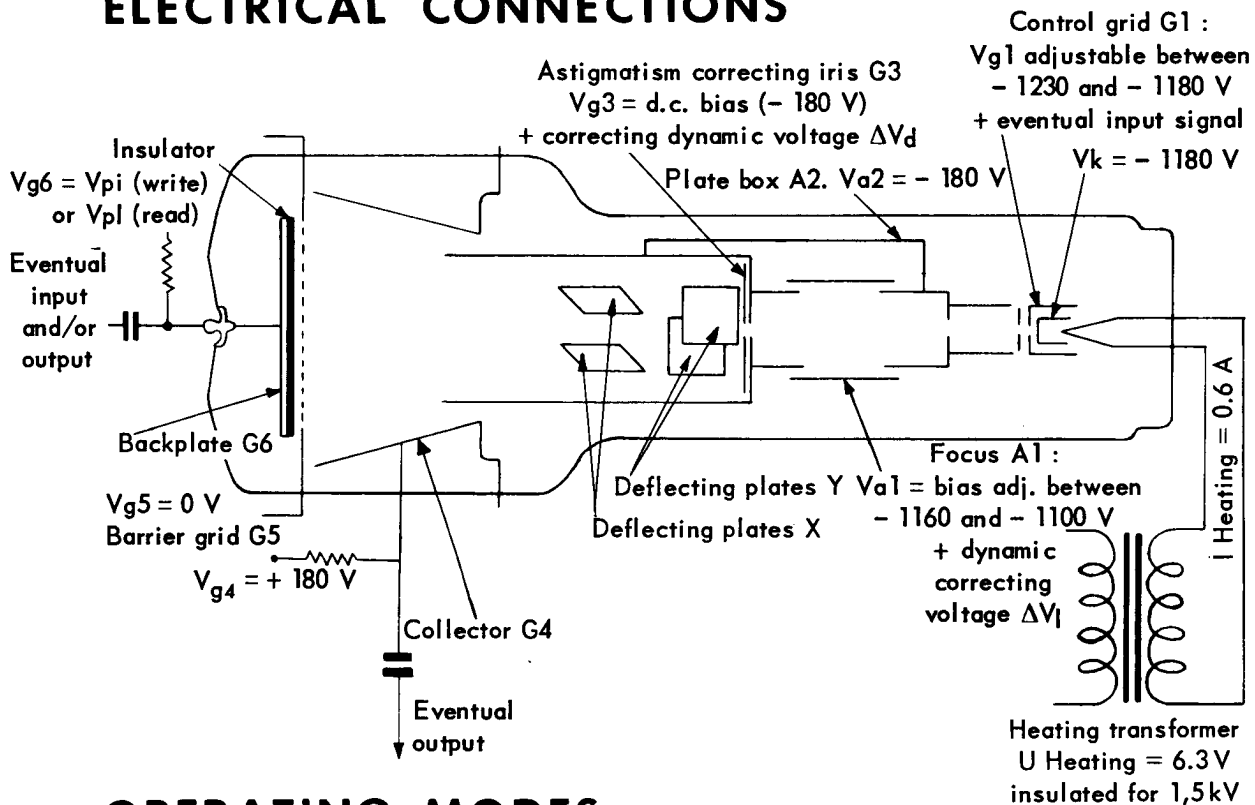

OPERATING MODES

WRITE

To write, the target backplate G6 is set to a d-c bias V_{pi} either positive or negative. The chosen value depends upon the desired writing intensity; in a certain application, ± 45 volt is used.

The signal to be written is sent either on the gun control grid G1 to amplitude modulate the beam or on the backplate G6 through a capacitor.

READ

To read the stored charge pattern, the target backplate G6 potential is switched to V_{pl} , usually 0 volt with respect to the grid. The target is then scanned by a unmodulated beam.

The read signal is taken either from the collector electrode G4 or from the backplate G6, through a capacitor.

Compagnie générale

Société Anonyme au Capital de 40.608.900 Nouveaux Francs
 Siège Social : 79, Bd HAUSSMANN - PARIS - 8^e - ANJ. 84-60



de télégraphie Sans Fil

DIVISION TUBES ÉLECTRONIQUES
 Direction Commerciale : 79, Bd Haussmann, PARIS-8^e - ANJ. 84-60

ERASE

The reading partially discharges the target. When total erasure is needed, the target backplate voltage is set to zero and the storage surface scanned by an unmodulated beam. This action completely discharges any stored pattern, bringing the whole storage surface to a uniform equilibrium potential.

STATIC OPERATING VALUES

Voltages (With respect to the barrier grid)

- Heater : 6.3 volt (insulated 1.5 kV w.r. to ground)
: 0.6 A
- Maximum cathode current : 3 mA
- Cathode K : - 1180 volt
- Control grid G1 : adjustable between - 1230 and - 1180 volt + eventual input signal
- Cut-off voltage : about - 1207 volt
- Focus electrode A1 : (concentration)
 - 1 - d.c. bias : adjustable between - 1100 and - 1160 volt
 - 2 - dynamic correcting voltage ΔV_f : see below
- Anode A2 : - 180 volt
- Astigmatism correcting iris G3 : (diaphragm)
 - 1 - d.c. bias : - 180 volt
 - 2 - dynamic correcting voltage ΔV_d : see below
- Collector G4 : + 180 volt - eventual output signal
- Barrier grid G5 : 0 volt
- Backplate G6 : d.c. bias : V_{pi} or V_{pl} (maximum value ± 90 volt)
eventual input and/or output signal.
- Beam current : $3 \mu A$ (Its variation vs V_{G1} is given on chart II, page 5)
- Usable target diameter : 50 millimeters

Capacitances :

- Backplate to barrier grid : about 1900 pF
- Collector to other electrodes : 15 pF
- One plate to the other, the remaining electrodes being grounded : 10 pF
- Control grid G1 to the other electrodes : 12 pF

Deflection sensitivity (both plates are fed symmetrically)

- x plates : 7 volt/mm
- y plates : 5 volt/mm

DYNAMIC FOCUSING CORRECTING VOLTAGES

Two dynamic voltages have to be applied to get the best resolution on the target edges, one ΔV_f on the focus electrode A1, the second ΔV_d on the astigmatism correcting iris G3. ΔV_d is added on G3 to V_{A2} (- 180 volt) and ΔV_f is added on A1 to the bias V_{A1} . ΔV_d is given versus the X deflecting voltage U_x on chart IV of the page 5. ΔV_f is the sum of :

$$\Delta V_f = \Delta V_{fx} + \Delta V_{fy}$$

ΔV_{fx} is given on the chart IV versus the X deflecting voltage U_x (see page 5)

ΔV_{fy} is given on the chart III versus the Y deflecting voltage U_y (see page 5)

Compagnie générale

Société Anonyme au Capital de 40.608.900 Nouveaux Francs
Siège Social : 79, Bd HAUSSMANN - PARIS-8^e - ANJ. 84-60



de télégraphie Sans Fil

DIVISION TUBES ÉLECTRONIQUES
Direction Commerciale : 79, Bd Haussmann, PARIS-8^e - ANJ. 84-60

DYNAMIC DATA

1 - RESOLUTION

The resolution measurements are made with orthogonal write and read, using a 200 μ s per target diameter scan speed. The writing backplate bias is $V_{pi} = + 45$ volt. Eight writings are made before the reading occurs.

Results are shown on the enclosed chart VI, page 6. For a relative amplitude of 50 %, the tube has about 700 T.V. lines.

2 - CHARGE AND DISCHARGE FACTOR

The discharge factor is the ratio of the first read signal to the second one after a certain number of writings. It depends on the value of the written charge, i.e. on the backplate bias during writing, on the number of writings, on the scan speed and on the beam current.

Typical values for the tube are :

Backplate bias during writing V_{pi}	Number of writings	Discharge factor
+ 45 V	8	3
+ 45 V	2	5
+ 10 V	8	4
+ 10 V	2	5

Those values are measured for a scan speed of 100 μ s per target diameter and 3 μ A for the beam current.

3 - SHADING AND DISTURBANCE

These measurements give informations about the response in signal of the tube.

They are made with a scan speed of 40 μ s per diameter, eight writings are used with a backplate bias $V_{pi} = + 45$ volt.

The read signal taken from the collector G4 or from the backplate G6 and grid G5 connected together has the shape shown on the enclosed diagram. (V, page 6)

Typical values for a TCM 15 X are :

- Maximum signal amplitude A 1
- Minimum signal amplitude B larger than 0.9
- "Shading" on the signal base C smaller than 0.05
- "Disturbance" on the signal base D smaller than 0.05
- "Disturbance" on the signal top E smaller than 0.07

SPECIFICATIONS FOR USE

A good shield of high magnetic permeability has to prevent the tube from the outside fields. The electronic spot should not stay motionless on the target, therefore the deflecting voltages have to be set before applying the anode voltage.

Compagnie générale

Société Anonyme au Capital de 40.608.900 Nouveaux Francs
Siège Social : 79, Bd HAUSSMANN - PARIS-8^e - ANJ. 84-60



de télégraphie Sans Fil

DIVISION TUBES ÉLECTRONIQUES
Direction Commerciale : 79, Bd Haussmann, PARIS-8^e - ANJ. 84-60

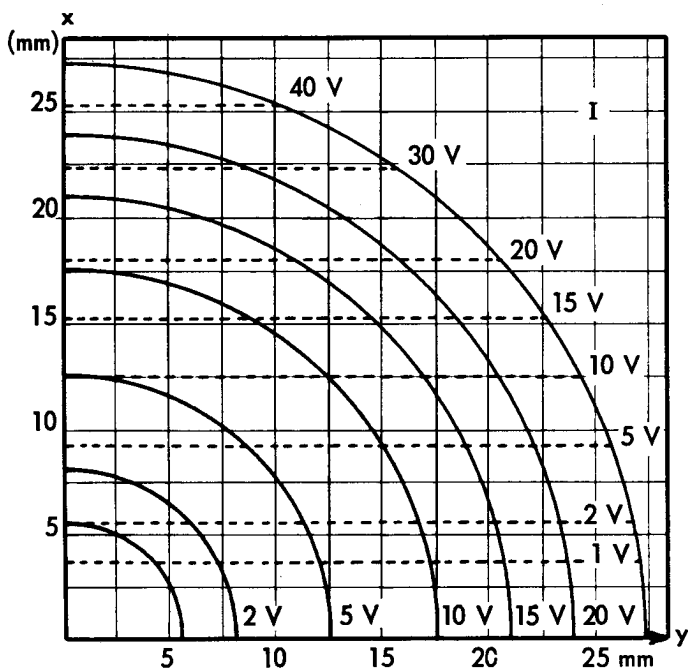

Astigmatism correction ΔV_d -----
 and focus correction ΔV_l ———
 as a function of the spot position on the target

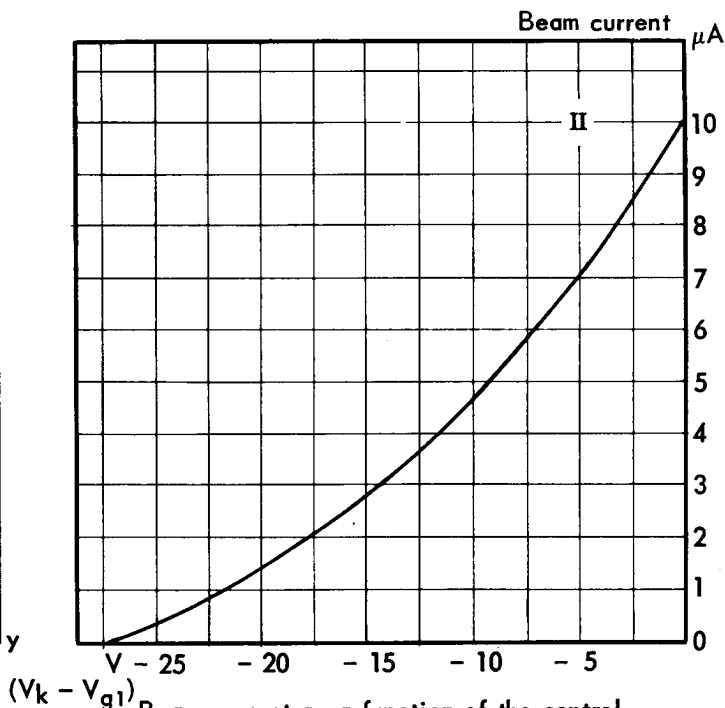

Beam current as a function of the control grid to cathode voltage.

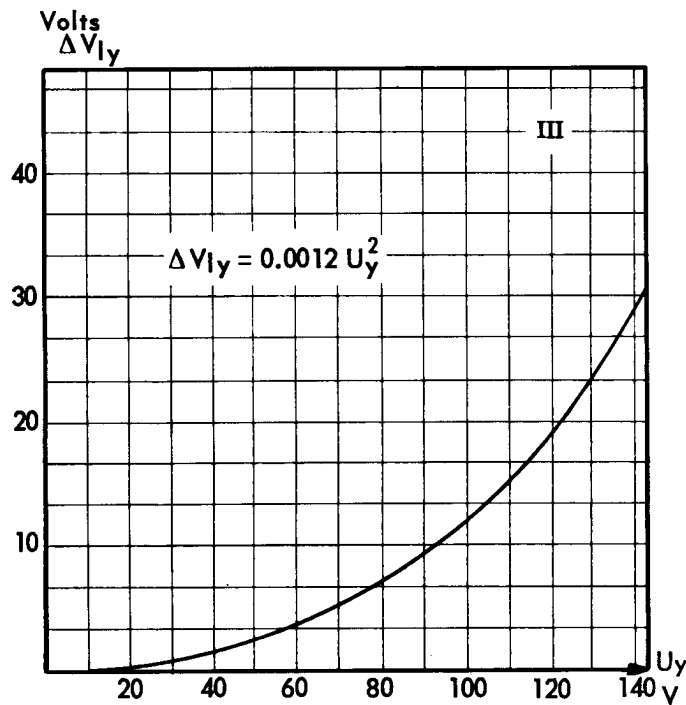

Dynamic voltage ΔV_{ly} versus y deflecting voltage U_y .

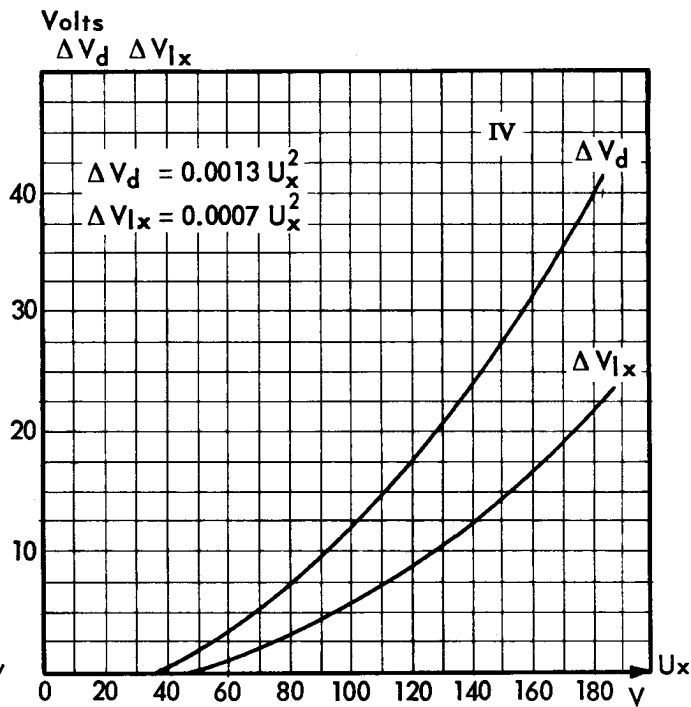

Dynamic correcting voltages ΔV_d and ΔV_{lx} versus x deflecting voltage U_x .

Compagnie générale

Société Anonyme au Capital de 40.608.900 Nouveaux Francs
 Siège Social : 79, Bd HAUSSMANN - PARIS - 8^e - ANJ. 84-60



de télégraphie Sans Fil

DIVISION TUBES ÉLECTRONIQUES
 Direction Commerciale : 79, Bd Haussmann, PARIS-8^e - ANJ. 84-60

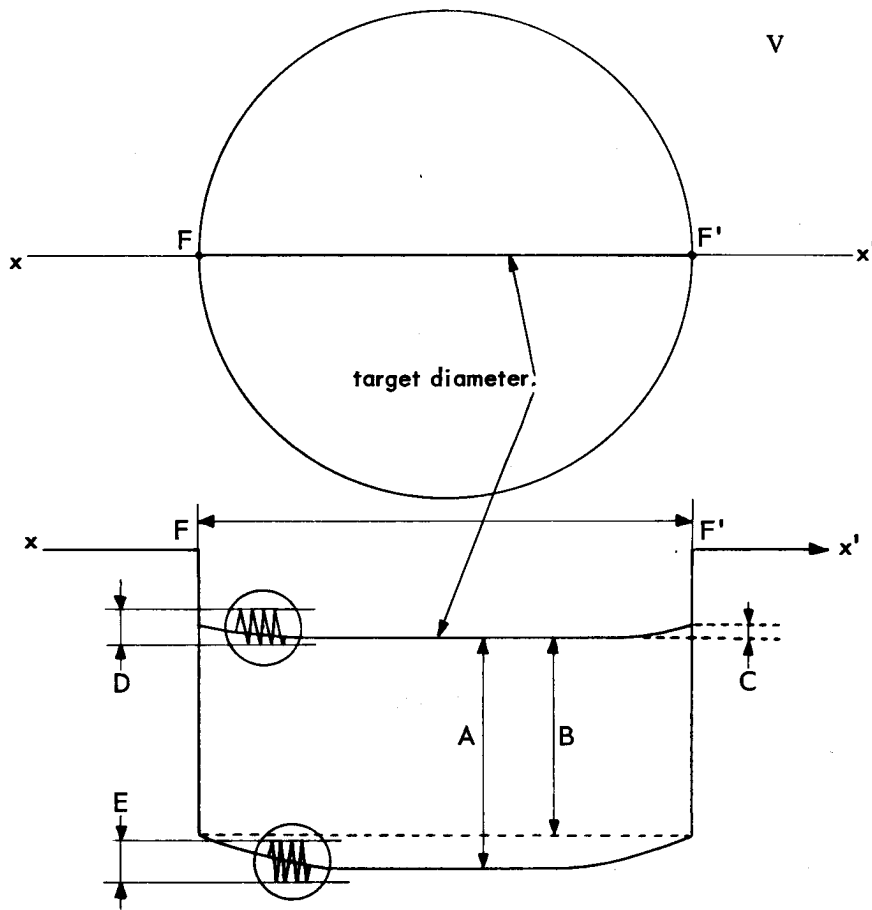

- A : maximum signal amplitude.
- B : minimum signal amplitude.
- C : "shading" (L.F. noise) in the signal base.
- D : "disturbance" (R.F. noise) in the signal base.
- E : "disturbance" (R.F. noise) in the signal top.

Read signal taken from the collector G4 or from the backplate G6 and grid G5 connected together as a function of spot position on the target diameter.

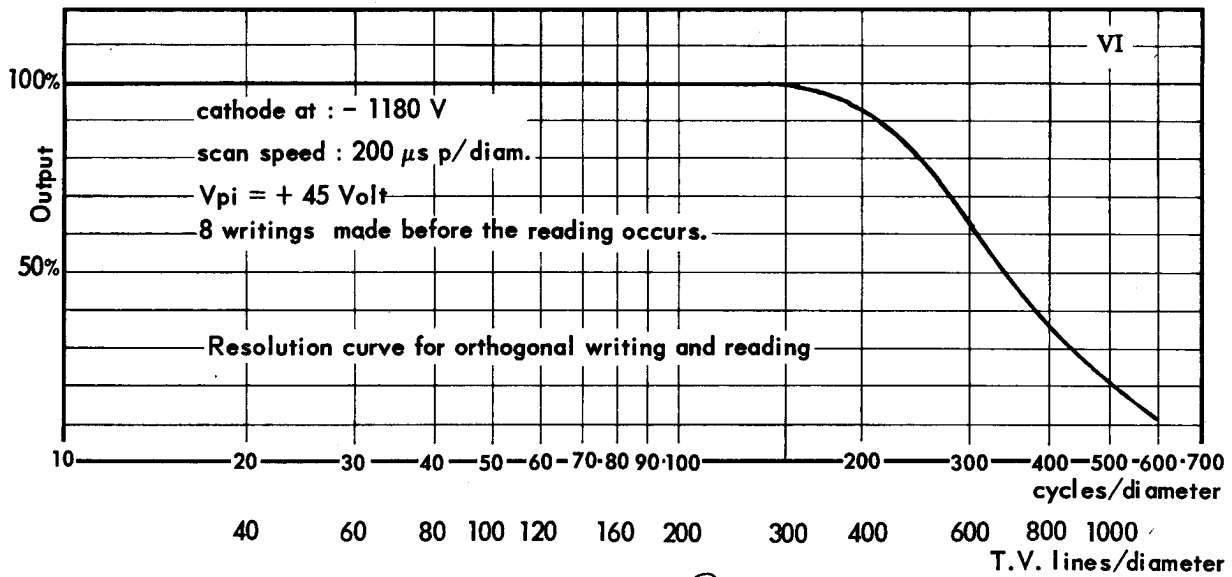

Compagnie générale

Société Anonyme au Capital de 40.608.900 Nouveaux Francs
Siège Social : 79, Bd HAUSSMANN - PARIS-8^e - ANJ. 84-60



de télégraphie Sans Fil

DIVISION TUBES ÉLECTRONIQUES
Direction Commerciale : 79, Bd Haussmann, PARIS-8^e - ANJ. 84-60